

Sinus Wash Canulae, Nasal Snares

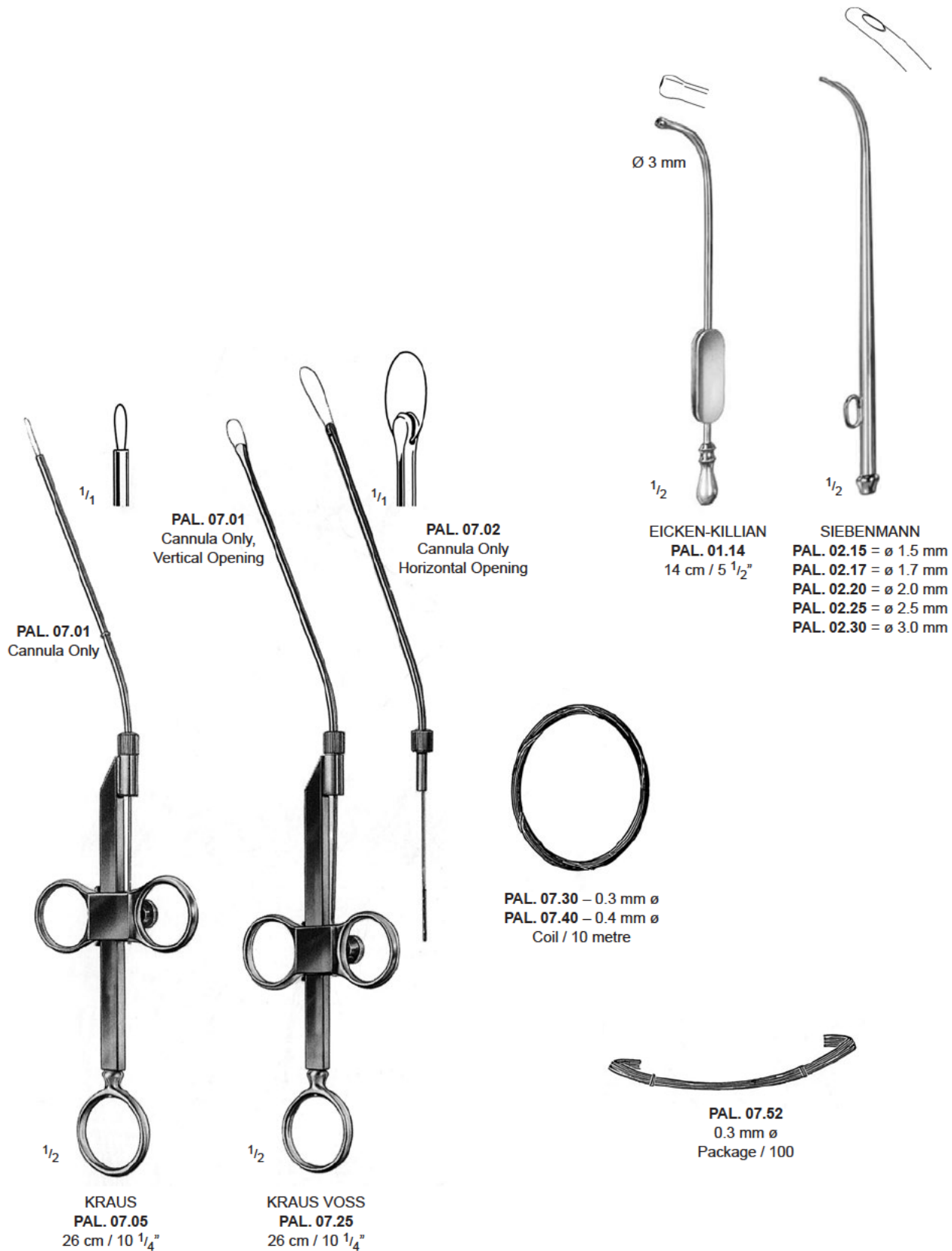

Dressing and Polypus Forceps

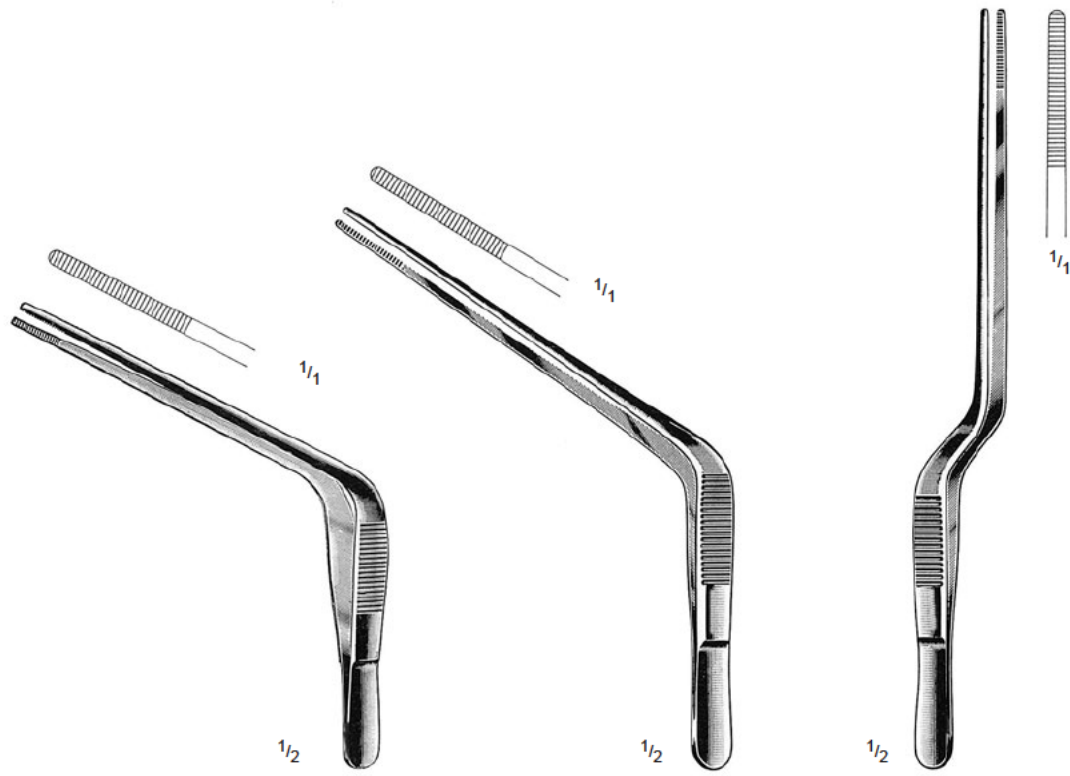

TROELTSCH
PAM. 01.15
 15 cm / 6"

TROELTSCH
PAM. 02.18
 18 cm / 7"

GRUENWALD (JANSEN)
PAM. 03.20
 20 cm / 8"

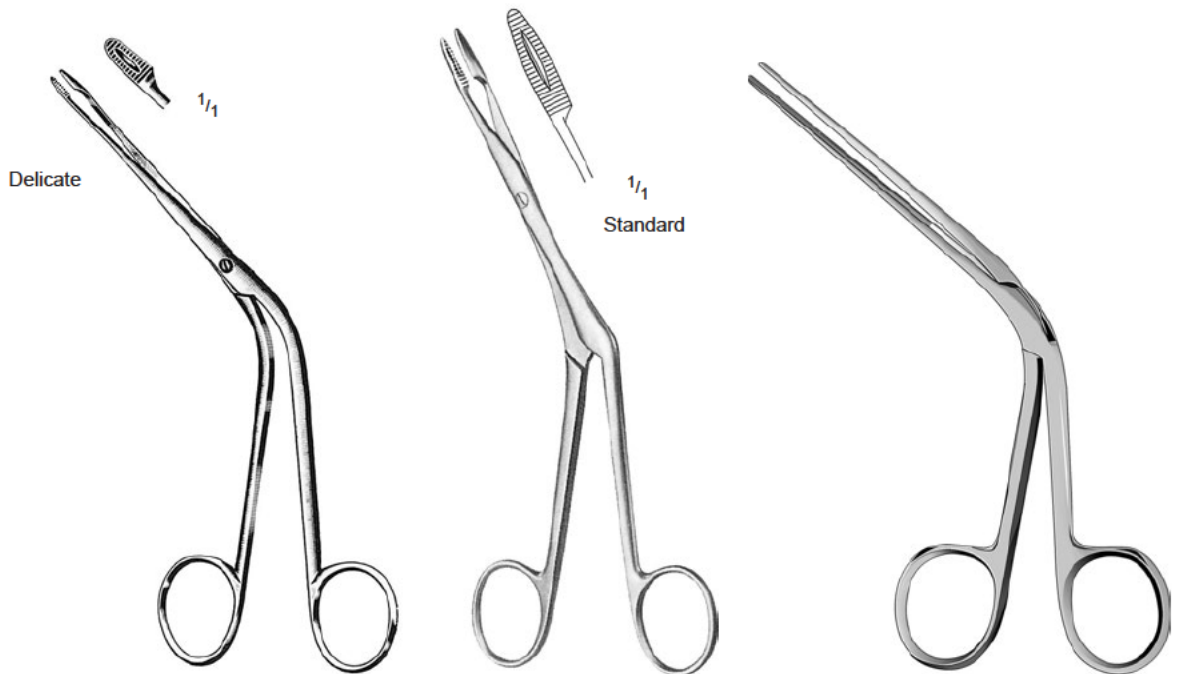

HARTMANN
PAM. 04.16
 16 cm / 6 1/4"

HARTMANN
PAM. 05.20
 20 cm / 8"

TILLEY
PAM. 07.35
 17 cm / 6 3/4"

Nasal Specula

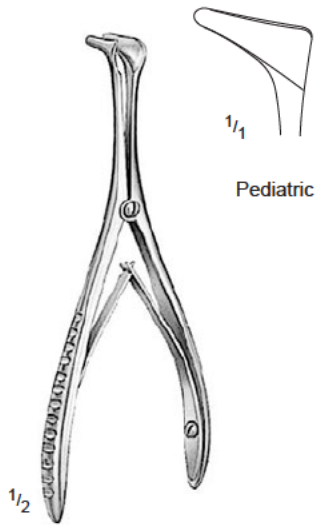

PROFESSIONAL
 PAM. 08.03
 13 cm / 5"

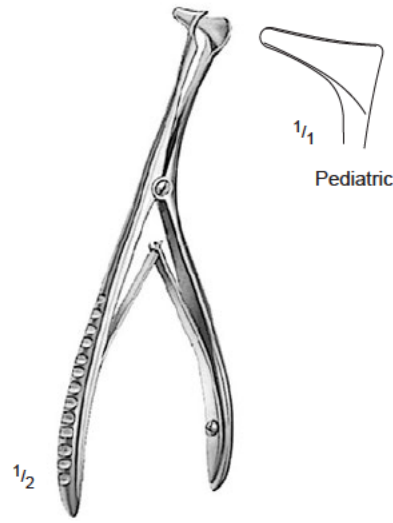

PROFESSIONAL
 PAM. 08.04
 13 cm / 5"

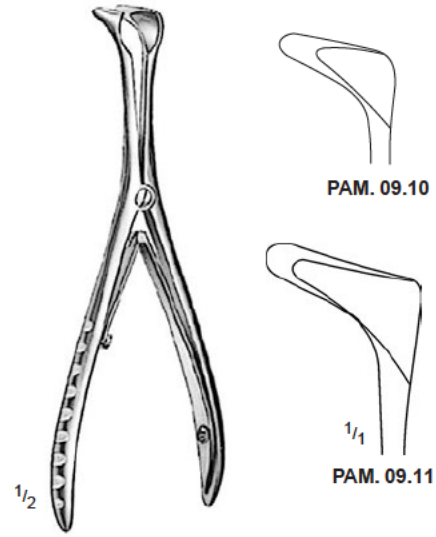

TIECK-HALLE
 PAM. 09.10 – PAM. 09.11
 13.5 cm / 5 1/4"

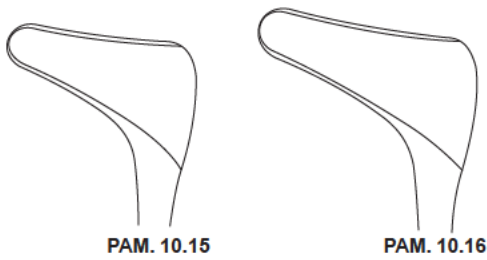

PAM. 10.15

PAM. 10.16

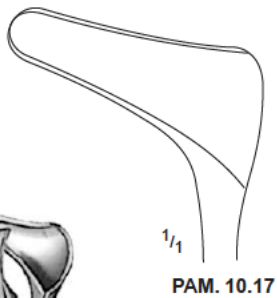

PAM. 10.17

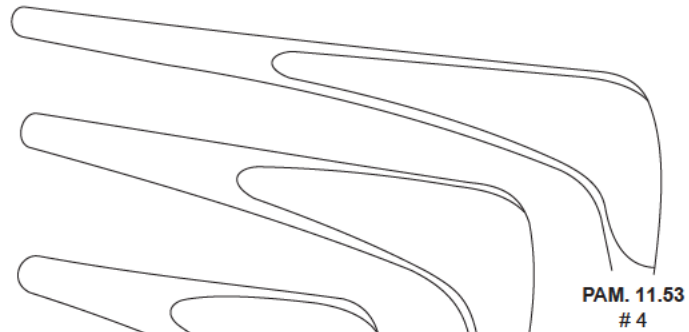

PAM. 11.53
 # 4

PAM. 11.52
 # 3

PAM. 11.51
 # 2

PAM. 11.50
 # 1



HARTMANN-HALLE
 PAM. 10.15 – PAM. 10.17
 15 cm / 6"



COTTLE
 PAM. 11.50 – PAM. 11.53
 15 cm / 6"

Nasal Specula



$\frac{1}{2}$
 KILLIAN
 PAM. 14.14 – PAM. 14.17
 14 cm / 5 $\frac{1}{2}$ "

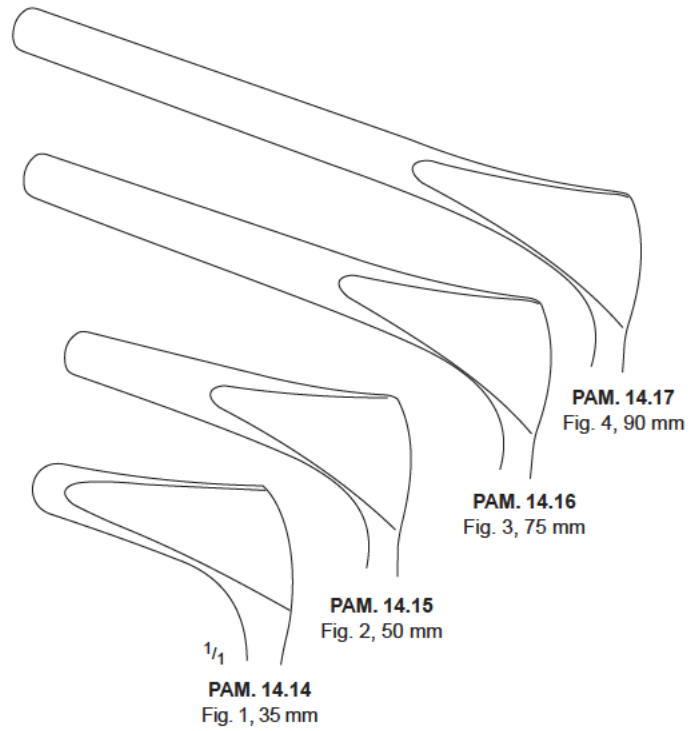

$\frac{1}{4}$
 PAM. 14.14
 Fig. 1, 35 mm

PAM. 14.15
 Fig. 2, 50 mm

PAM. 14.16
 Fig. 3, 75 mm

PAM. 14.17
 Fig. 4, 90 mm

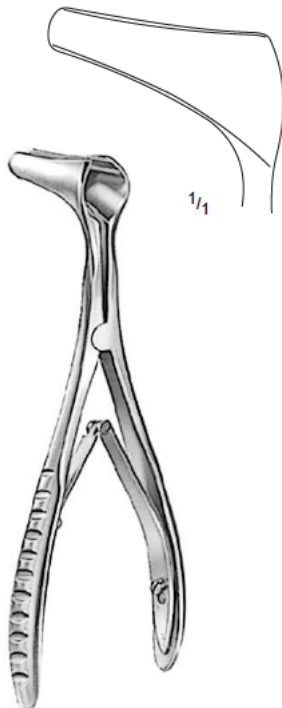

$\frac{1}{4}$
 VIENNA PATTERN
 PAM. 16.16
 15 cm / 6"

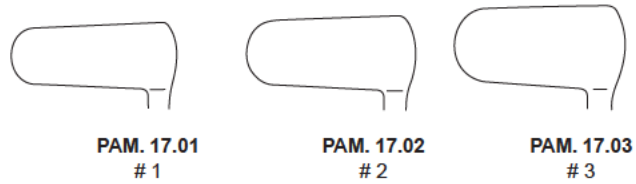

PAM. 17.01
 # 1

PAM. 17.02
 # 2

PAM. 17.03
 # 3



GOLDSMITH (THUDICUM)
 PAM. 17.01 – PAM. 17.03
 6.5 cm / 2 $\frac{1}{2}$ "

Nasal Scissors, Septum Knives, Septum Elevators

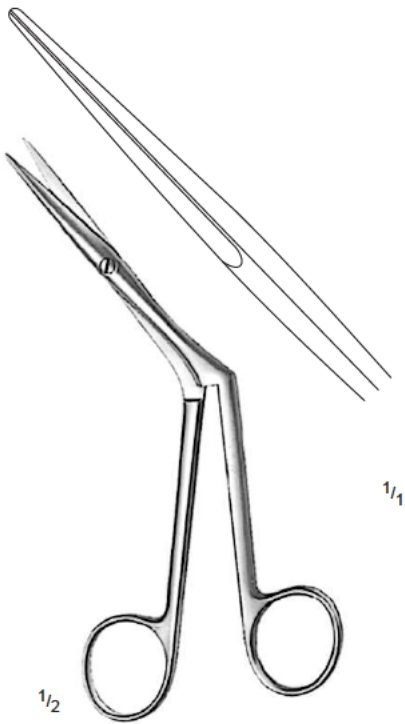

HEYMANN-KNIGHT
 PAM. 17.18
 18 cm / 7"

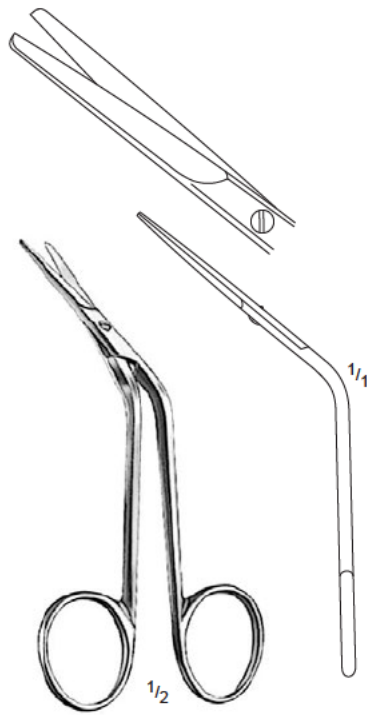

FOMON
 PAM. 50.15
 15 cm / 6"

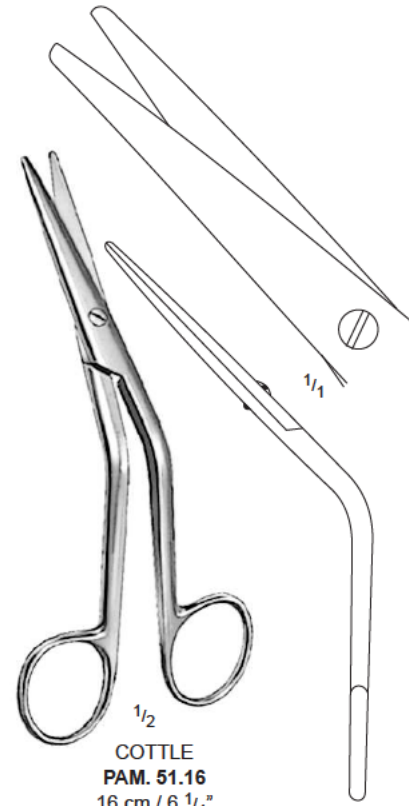

COTTLE
 PAM. 51.16
 16 cm / 6 1/4"



BLALENGER
 PAM. 21.19 – PAM. 21.22
 20 cm / 8"



PAM. 21.19
 PAM. 22.19
 3.0 mm



PAM. 21.20
 PAM. 22.20
 4.0 mm



PAM. 21.22
 PAM. 22.22
 5.0 mm



BLALENGER
 Bayonet Shape
 PAM. 22.19 – PAM. 22.22
 20 cm / 8"

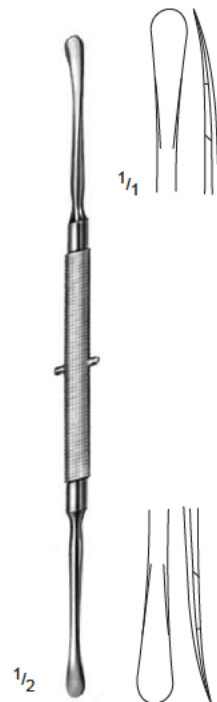

FREER
 PAM. 28.21
 21 cm / 8 1/4"

Septum Elevators, Compression Forceps

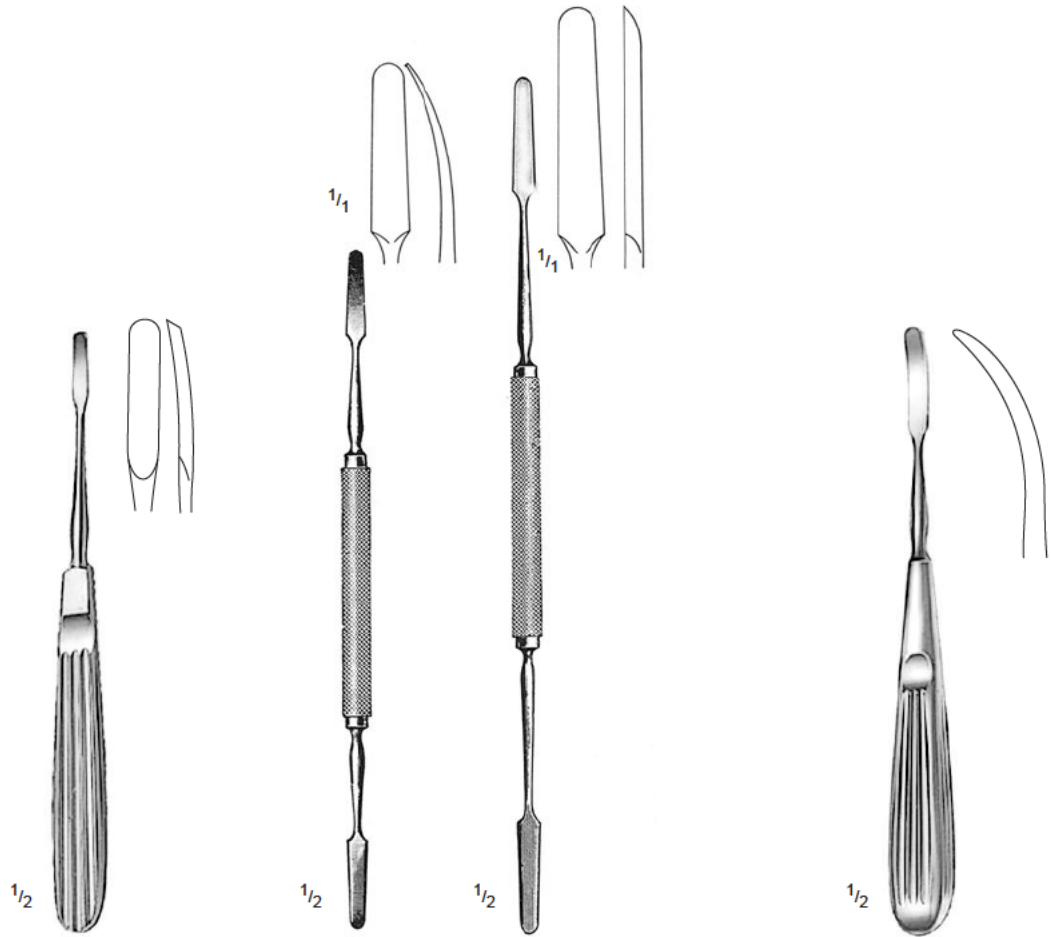

JOSEPH
 PAM. 33.16
 16 cm / 6 1/4"

KILLIAN
 PAM. 34.18
 18 cm / 7"

KILLIAN
 PAM. 34.22
 22 cm / 8 3/4"

JOSEPH
 PAM. 35.16
 16 cm / 6 1/4"

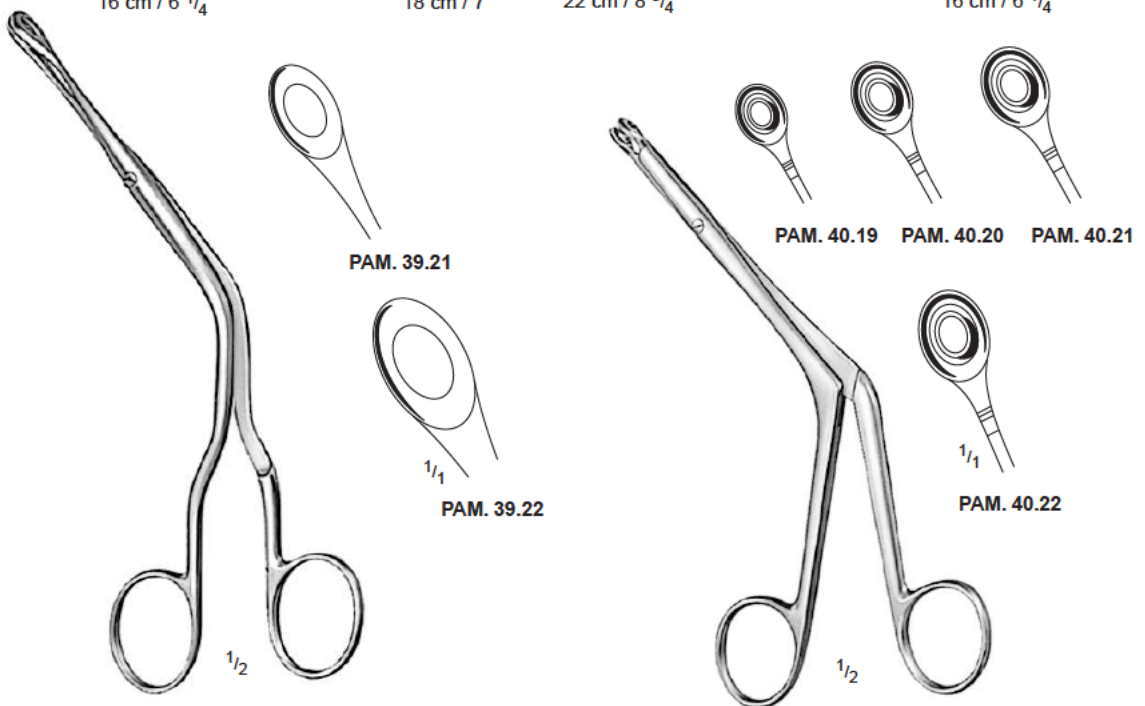

LUC
 PAM. 39.21 – PAM. 39.22
 20 cm / 8"

BRUENINGS
 PAM. 40.19 – PAM. 40.22
 19 cm / 7 1/2"

Nasal Cutting Forceps



PAM. 44.01 – PAM. 44.05



PAM. 44.01



PAM. 44.02



PAM. 44.03



PAM. 44.04



PAM. 44.05



PAM. 44.10 – PAM. 44.14



PAM. 44.10



PAM. 44.11



PAM. 44.12



PAM. 44.13



PAM. 44.14

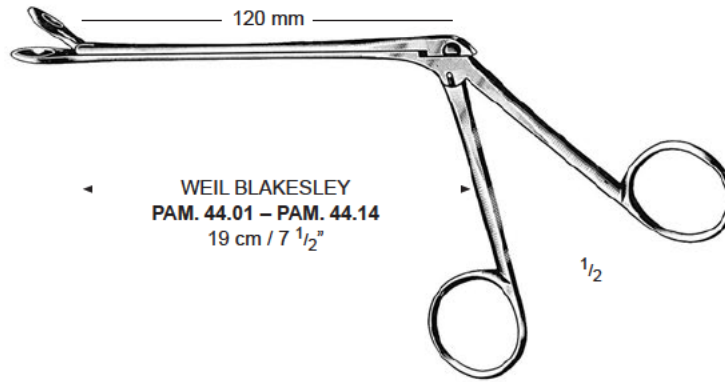

WEIL BLAKESLEY
PAM. 44.01 – PAM. 44.14
19 cm / 7 1/2"

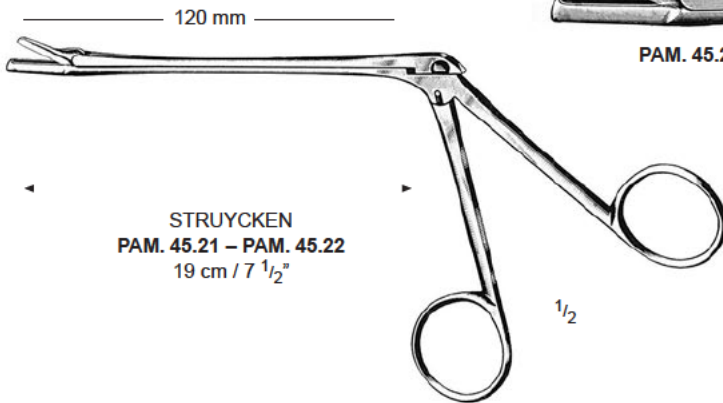

STRUYCKEN
PAM. 45.21 – PAM. 45.22
19 cm / 7 1/2"

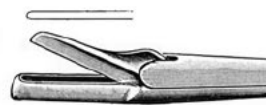

PAM. 45.21

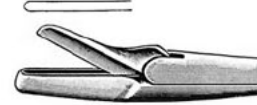

PAM. 45.22

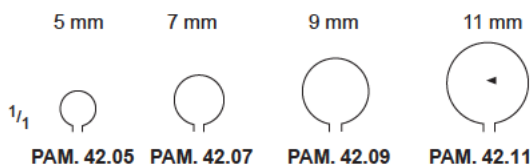

PAM. 42.05

PAM. 42.07

PAM. 42.09

PAM. 42.11

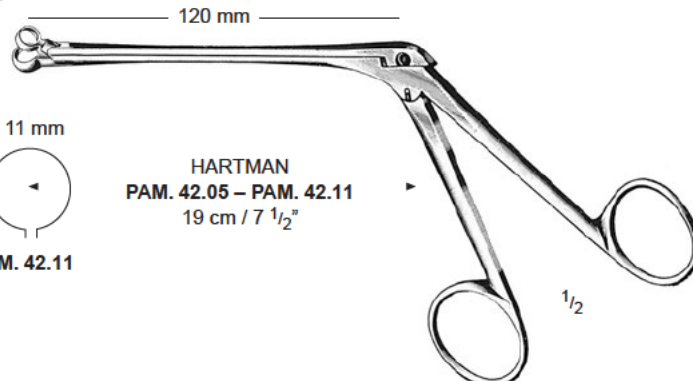

HARTMAN
PAM. 42.05 – PAM. 42.11
19 cm / 7 1/2"





Septum Compression Forceps, Punch Forceps, Rhinoplastic Instruments



JANSEN MIDDLETON
 PAM. 49.19
 19 cm / 7 1/2"



KERRISON
 PAM. 65.01 – PAM. 65.04
 20 cm / 8"

- 3 mm

 PAM. 65.01
- 4 mm

 PAM. 65.02
- 5 mm

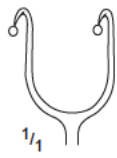
 PAM. 65.03
- 6 mm

 PAM. 65.04



FOMON
 PAN. 01.15
 15 cm / 6"



JOSEPH
 PAN. 08.15
 15 cm / 6"



CONVERSE
 PAN. 09.12
 12 cm / 4 3/4"

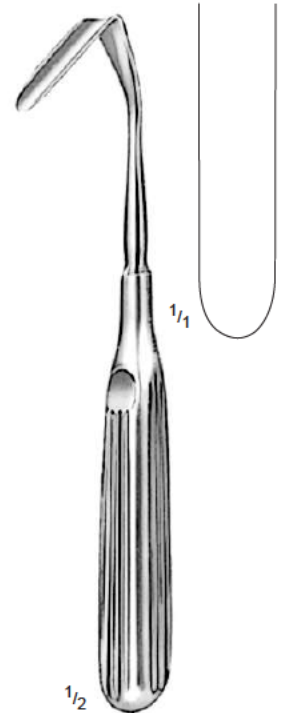

AUFRICHT
 PAN. 10.19
 19 cm / 7 1/2"

Rhinoplastic Instruments

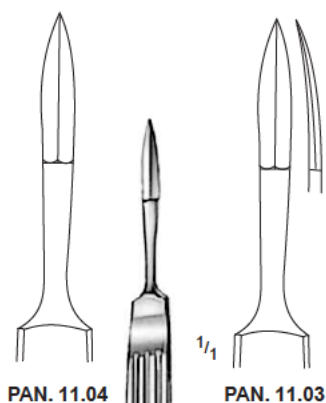

PAN. 11.04

PAN. 11.03

1/2

1/1

JOSEPH
 PAN. 11.03 – PAN. 11.04
 16 cm / 6 1/4"

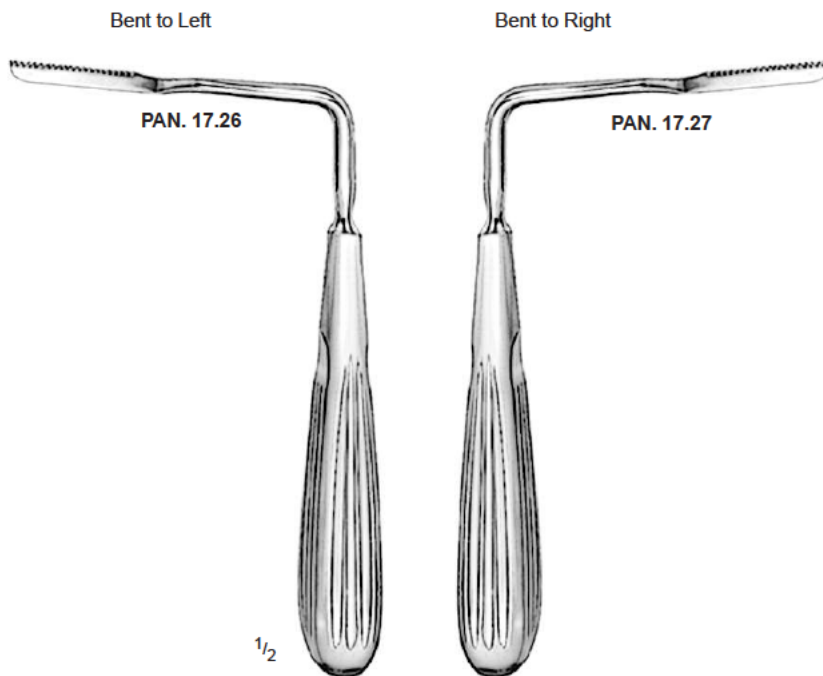

Bent to Left

Bent to Right

PAN. 17.26

PAN. 17.27

1/2

JOSEPH
 PAN. 17.26 – PAN. 17.27
 17 cm / 6 3/4"

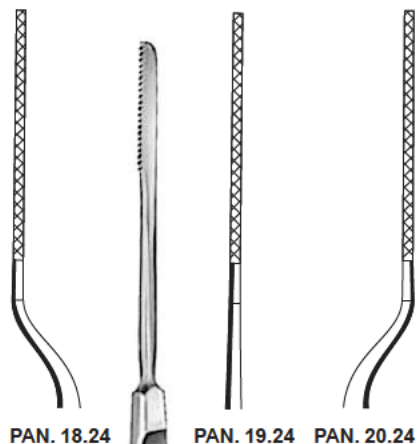

PAN. 18.24

PAN. 19.24

PAN. 20.24

1/2

JOSEPH
 PAN. 18.24 – PAN. 20.24
 19 cm / 7 1/2"

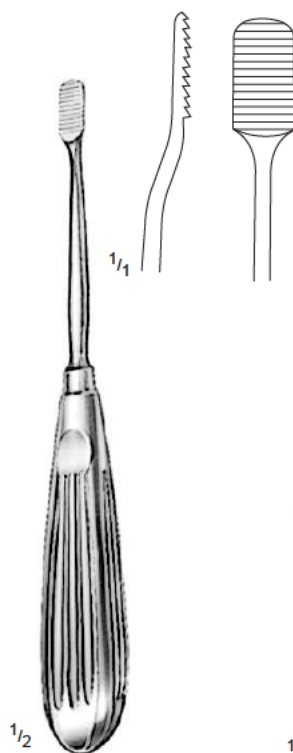

1/1

1/2

LEWIS
 PAN. 24.26
 18 cm / 7"

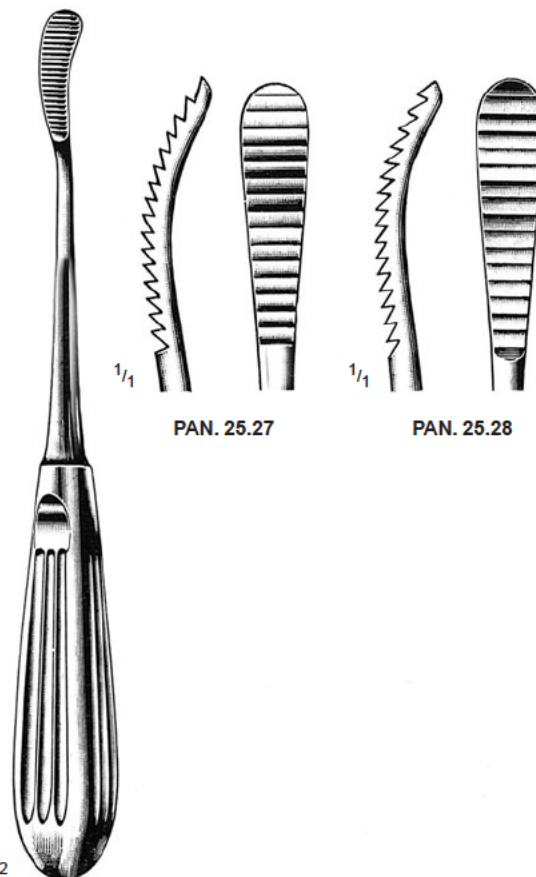

1/1

1/1

1/2

AUFRICHT
 PAN. 25.27 – PAN. 25.28
 21 cm / 8 1/4"

Rhinoplastic Instruments

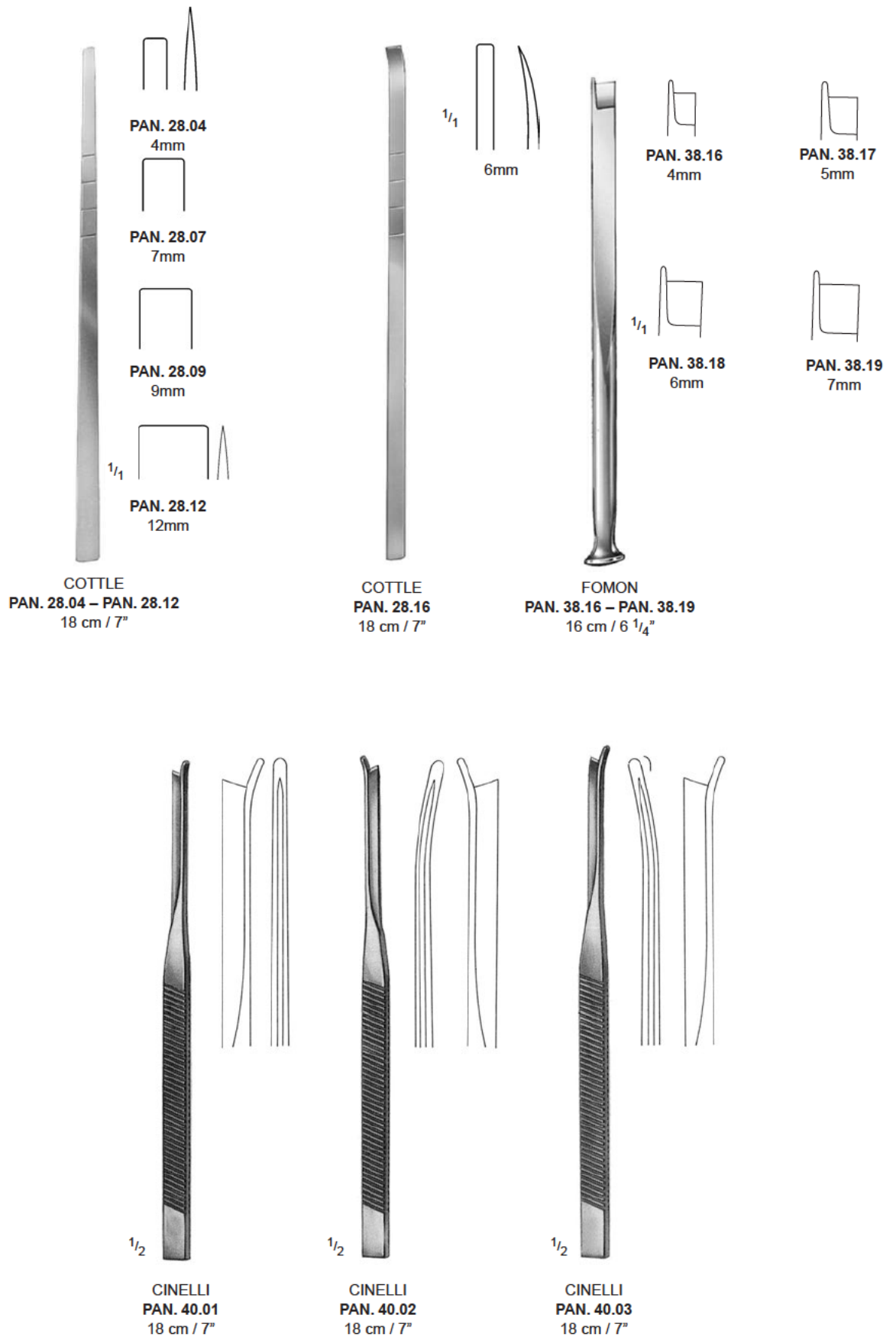

Septum Forceps

