

Bulldog Clamps

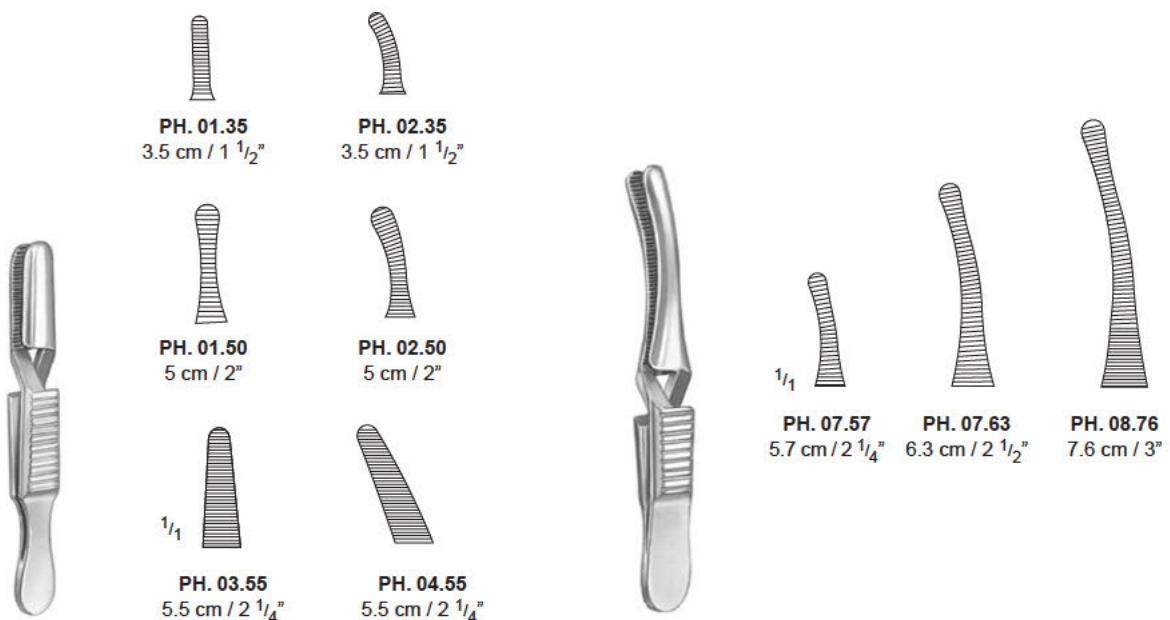

DIEFFENBACH
 PH. 01.35 – PH. 04.55

JOHNS- HOPKINS
 PH. 07.57 – PH. 08.76



DIETHRIC
 PH. 05.08 – PH. 05.22

	PH. 05.08	PH. 05.10	PH. 05.12	PH. 05.18	PH. 05.20	PH. 05.22
Length	50 mm	50 mm	60 mm	50 mm	50 mm	60 mm
Jaws	8 mm	12 mm	20 mm	8 mm	12 mm	20 mm
Weight	3 gm	3 gm	3 gm	3 gm	3 gm	3 gm

Artery Forceps



HALSTEAD MOSQUITO
 PH. 10.12 – PH. 19.14



PH. 10.12
 12.5 cm / 5"

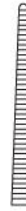

PH. 12.12
 14 cm / 5 1/2"



PH. 11.12
 12.5 cm / 5"



PH. 13.12
 14 cm / 5 1/2"



PH. 18.12
 12.5 cm / 5"
 1 x 2 teeth



PH. 18.14
 14 cm / 5 1/2"
 1 x 2 teeth



PH. 19.12
 12.5 cm / 5"
 1 x 2 teeth



PH. 19.14
 14 cm / 5 1/2"
 1 x 2 teeth



MICRO- HALSTEAD MOSQUITO
 PH. 10.22 – PH. 19.22



PH. 10.22
 12.5 cm / 5"



PH. 13.22
 12.5 cm / 5"



PH. 18.22
 12.5 cm / 5"
 1 x 2 teeth



PH. 19.22
 12.5 cm / 5"
 1 x 2 teeth

Artery Forceps



CHAPUT
 PH. 20.13
 13 cm / 5"



TUFFIER
 PH. 22.13
 13 cm / 5"

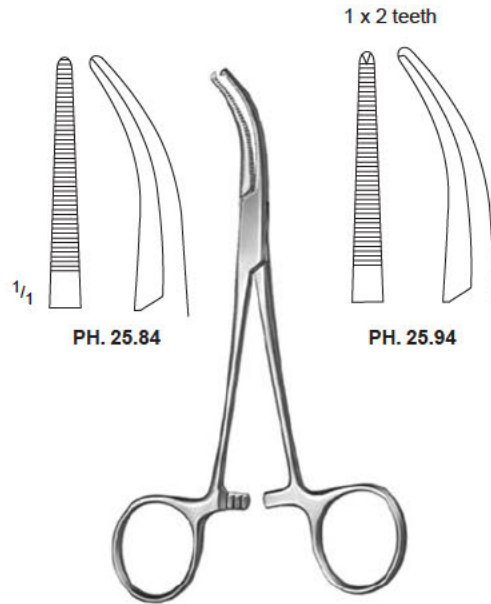

DANDY
 PH. 25.84 – PH. 25.94
 14 cm / 5 1/2"

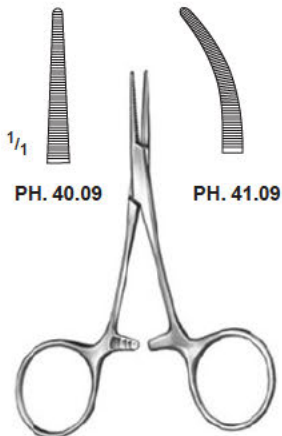

HARTMANN
 (BABY MOSQUITO)
 PH. 40.09 – PH. 41.09
 9 cm / 3 1/2"

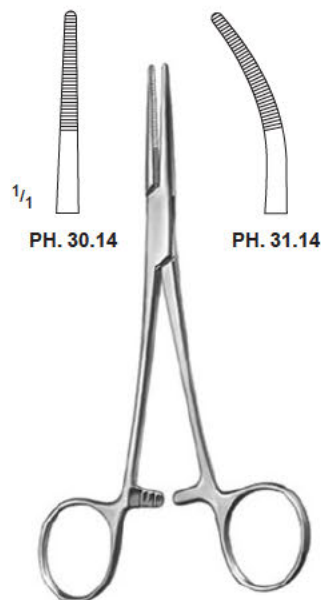

PROVIDENCE HOSPITAL
 PH. 30.14 – PH. 31.14
 14 cm / 5 1/2"

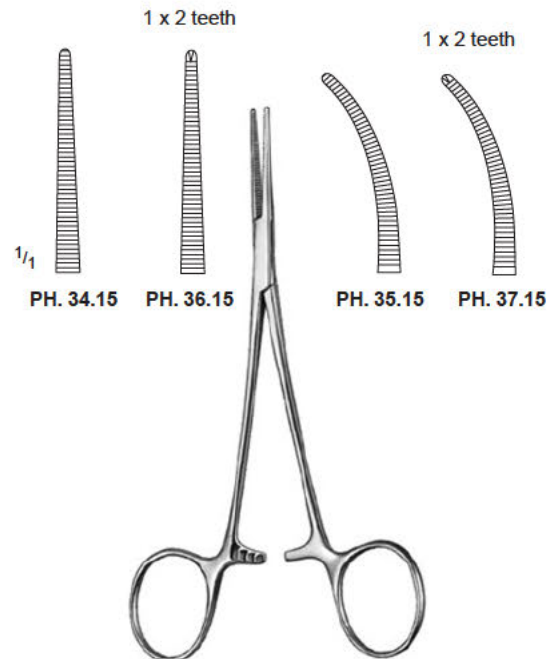

LERICHE
 PH. 34.15 – PH. 37.15
 15 cm / 6"

Artery Forceps

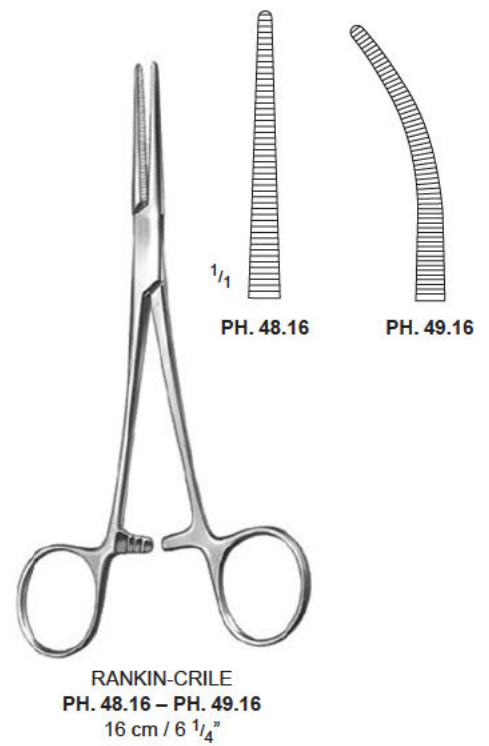
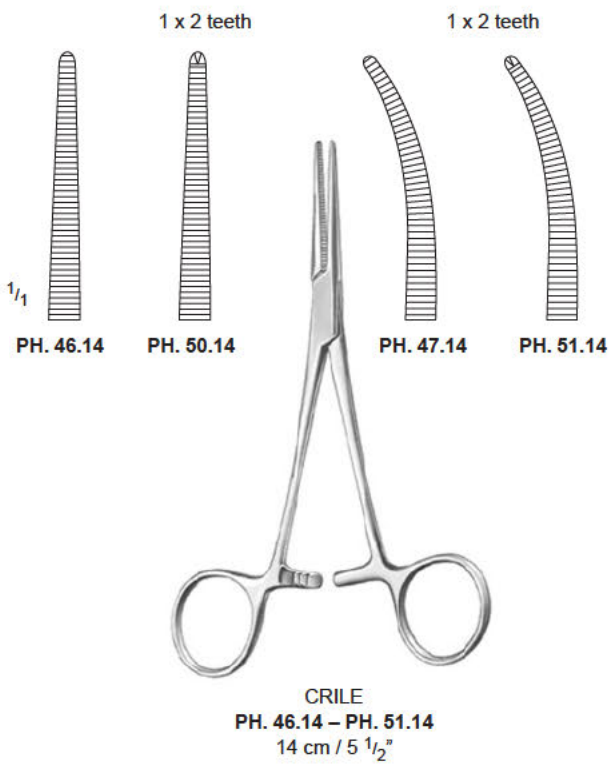
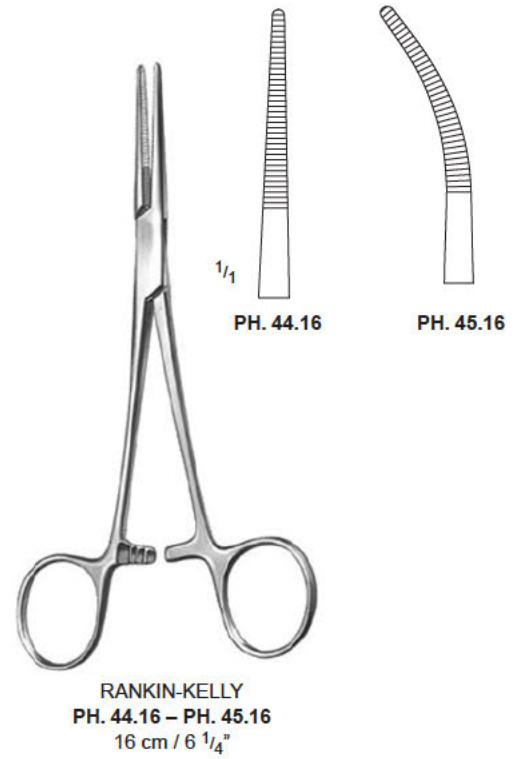
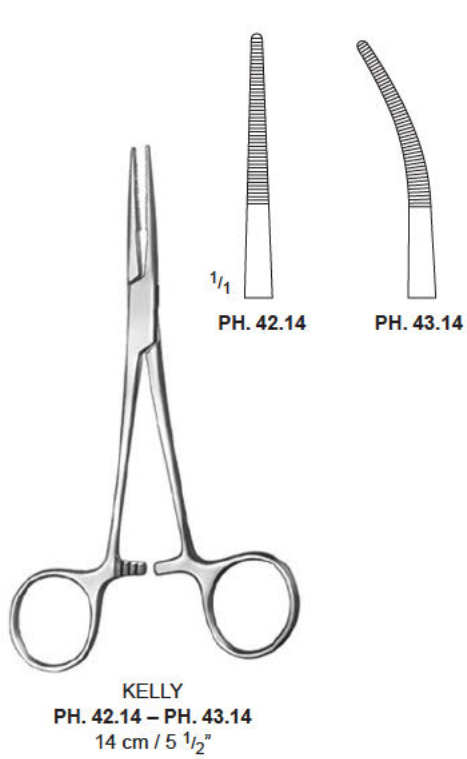

Artery Forceps

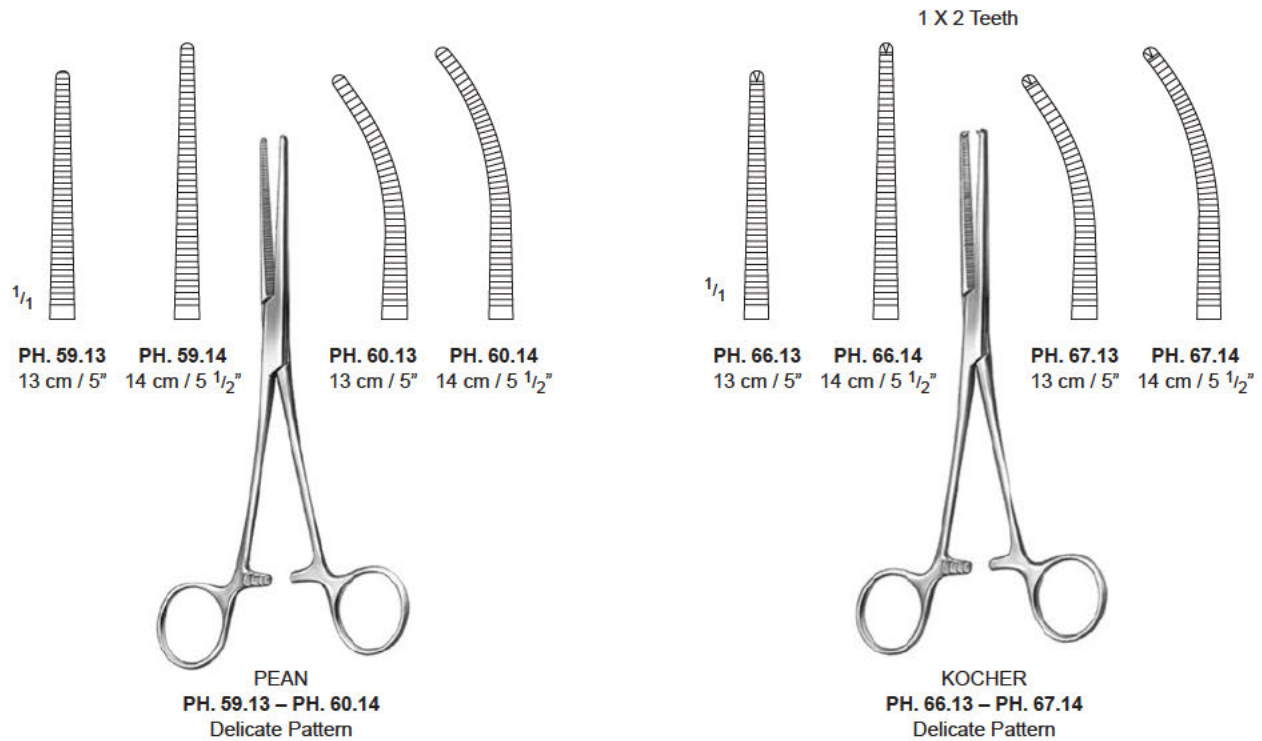
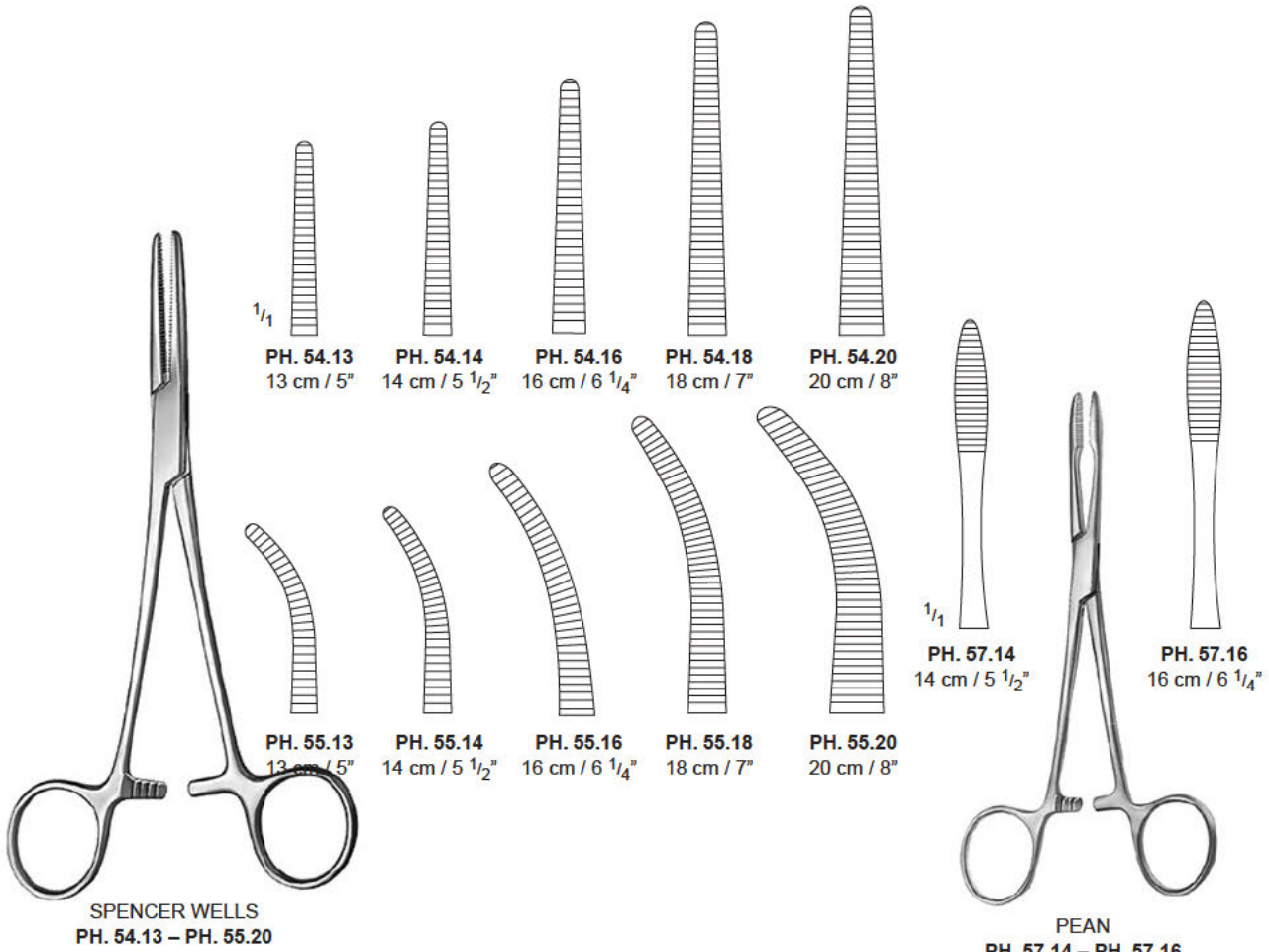

Artery Forceps

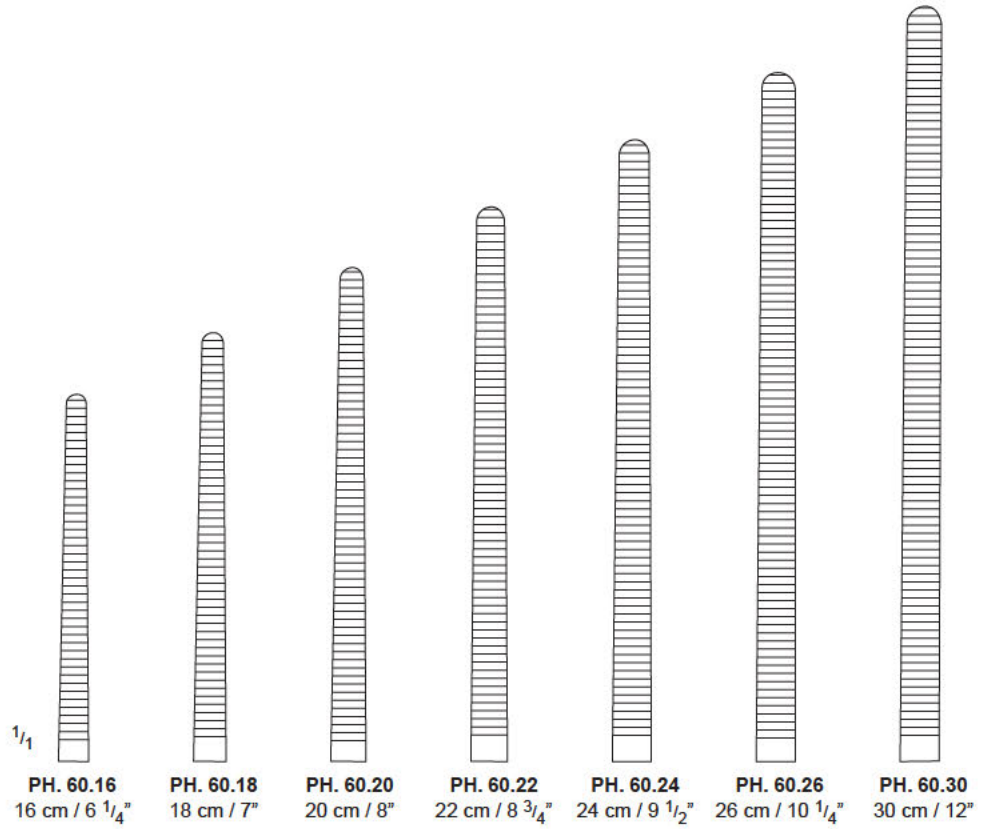

PEAN (ROCHESTER)
 PH. 60.16 – PH. 60.30
 PH. 56.16 – PH. 56.30

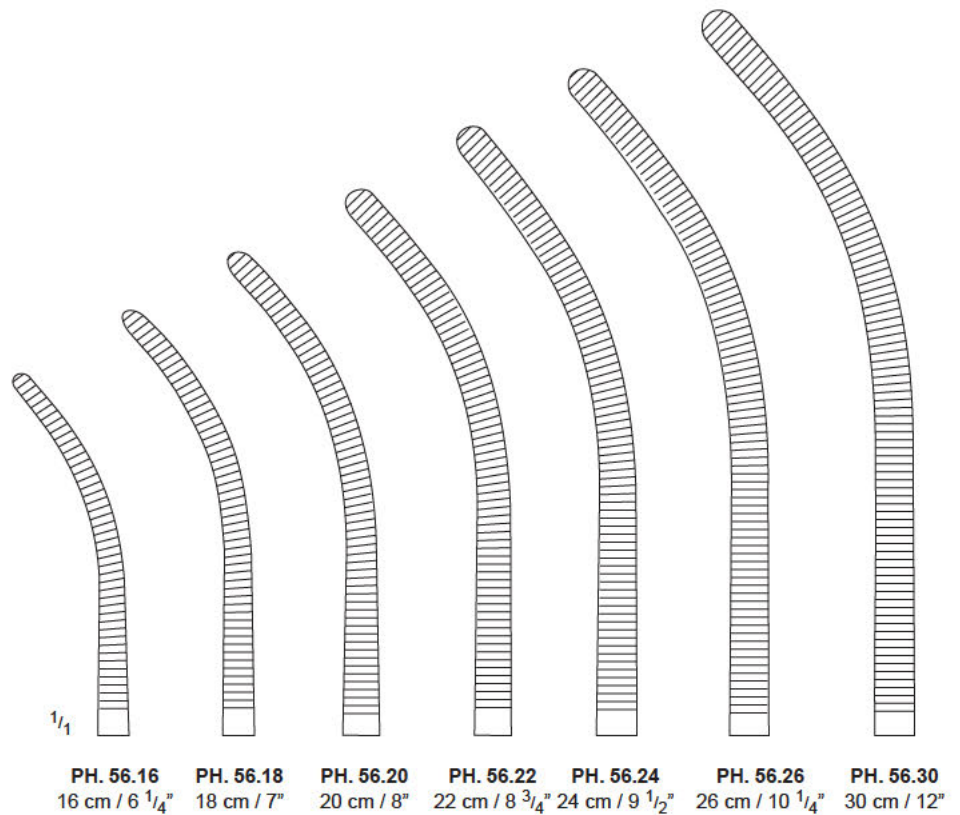

Artery Forceps

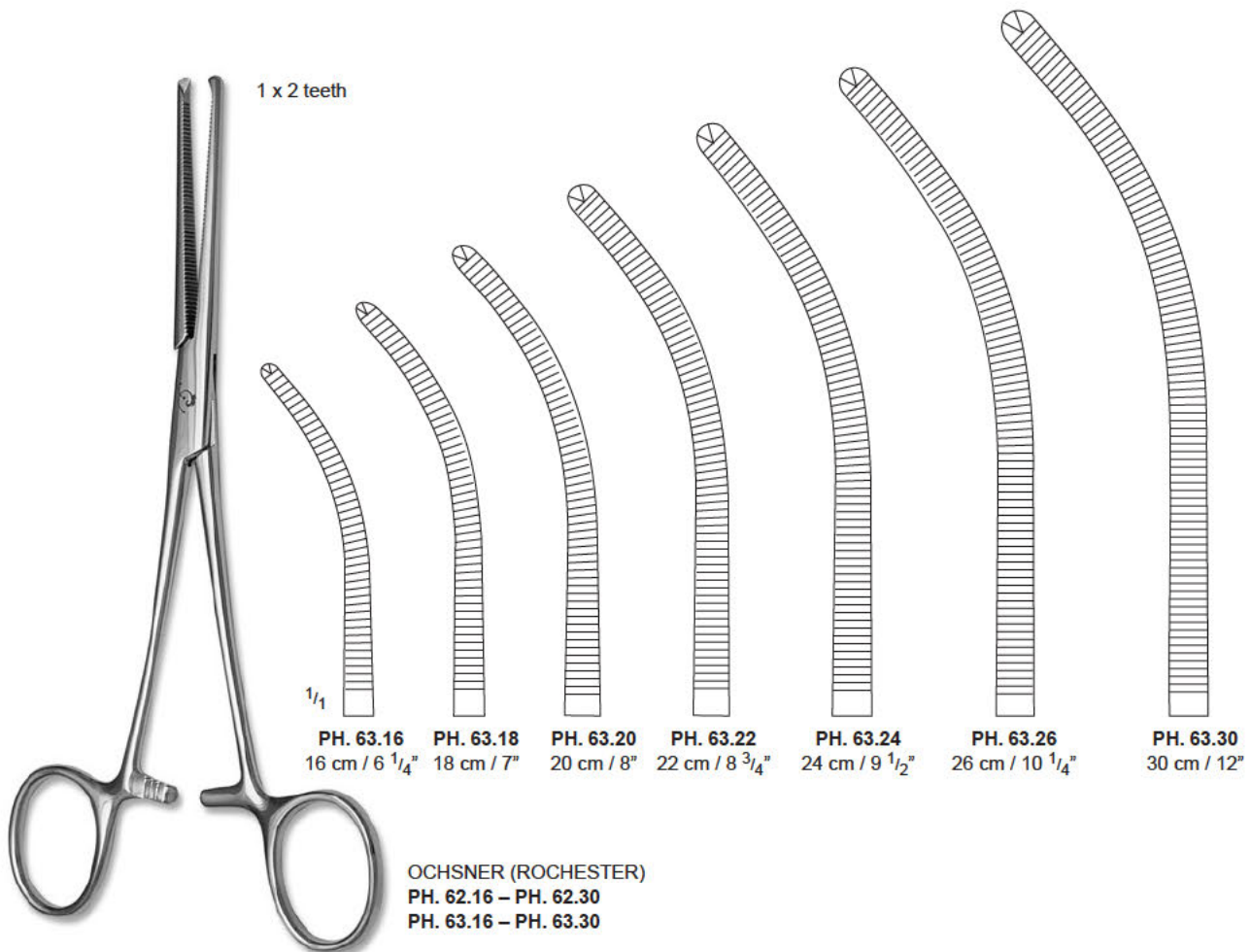
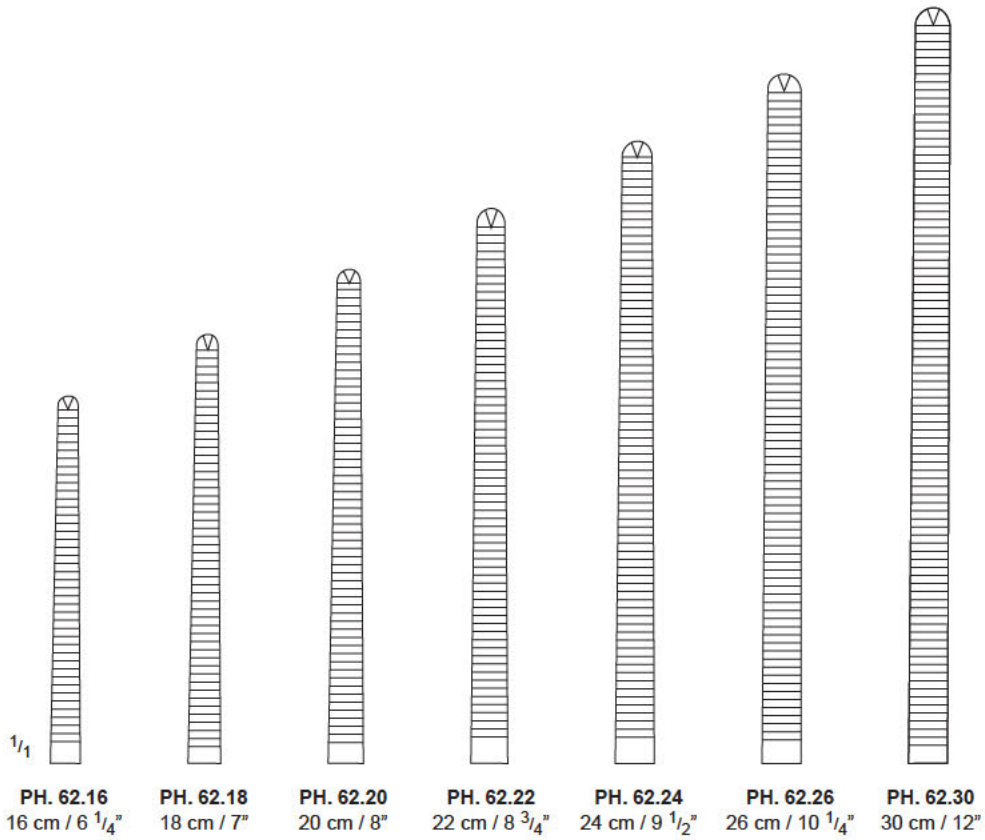

Artery Forceps

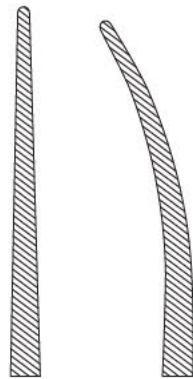

PH. 64.20 PH. 64.21
20 cm / 8"

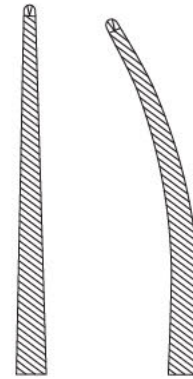

PH. 65.20 PH. 65.21
20 cm / 8"
1x2 teeth

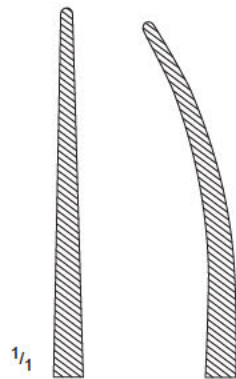

PH. 64.26 PH. 64.27
26 cm / 10 1/4"

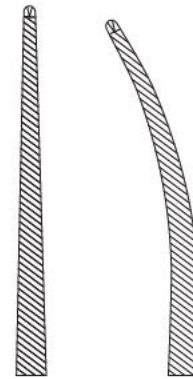

PH. 65.26 PH. 65.27
26 cm / 10 1/4"
1x2 teeth



BENGOLEA
PH. 64.20 – PH.65.27

Artery Forceps, Dissecting & Ligature Forceps



ZENKER
PH. 68.29 – PH. 68.30
29.5 cm / 11 1/2"

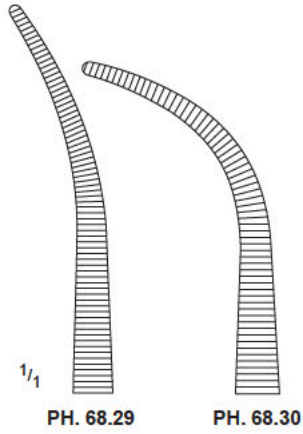

RUMEL
PH. 69.01 – PH. 69.05
23 cm / 9"

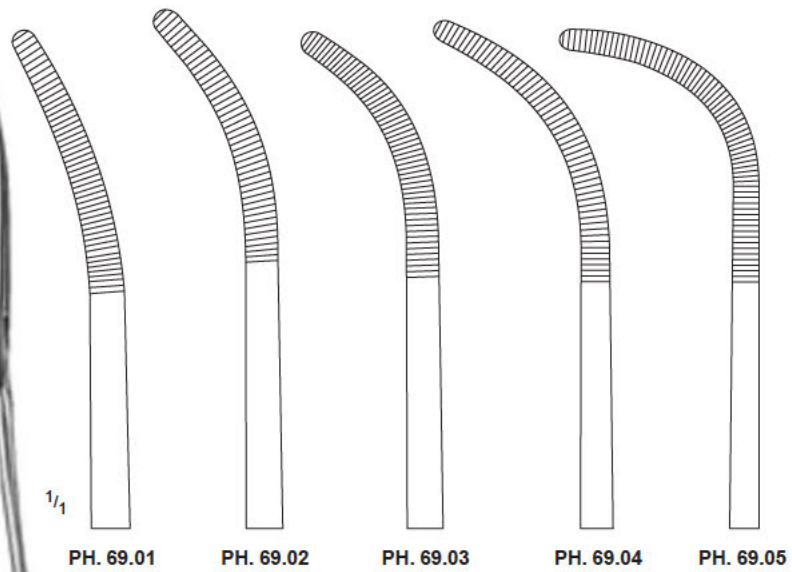

Artery Forceps, Hysterectomy and Vaginal Clamp Forceps

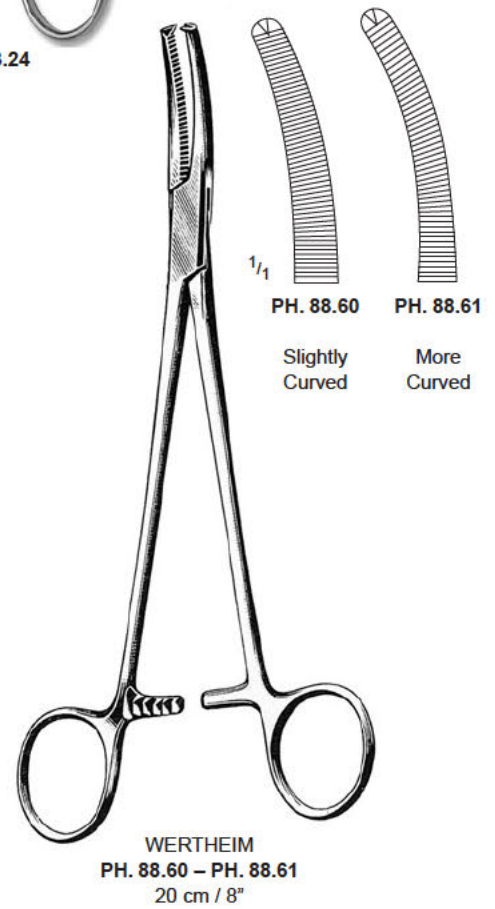
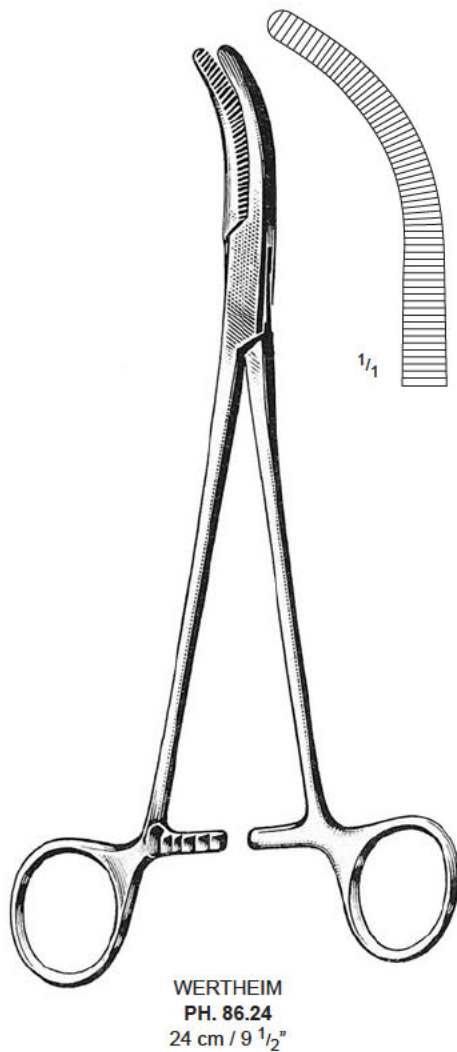
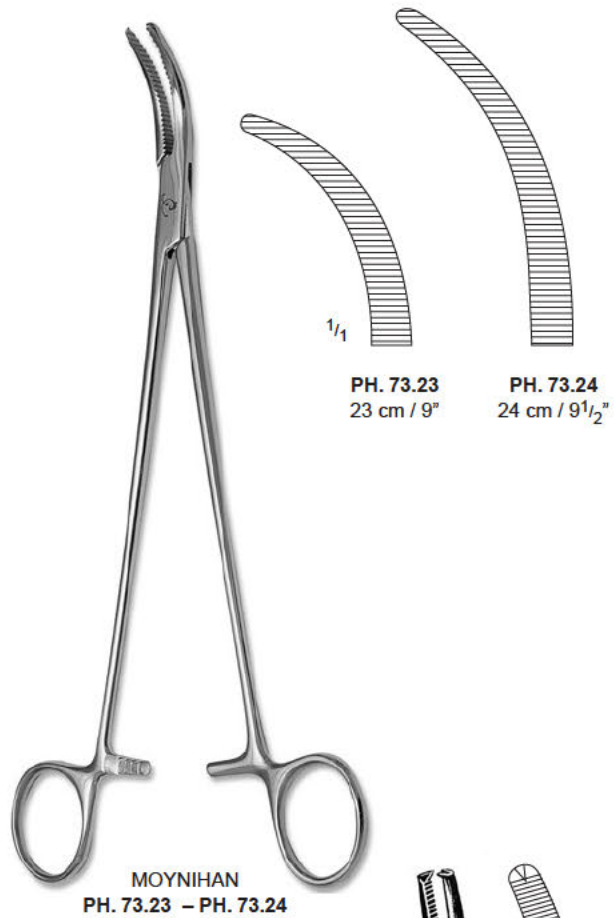

Artery Forceps, Clamps

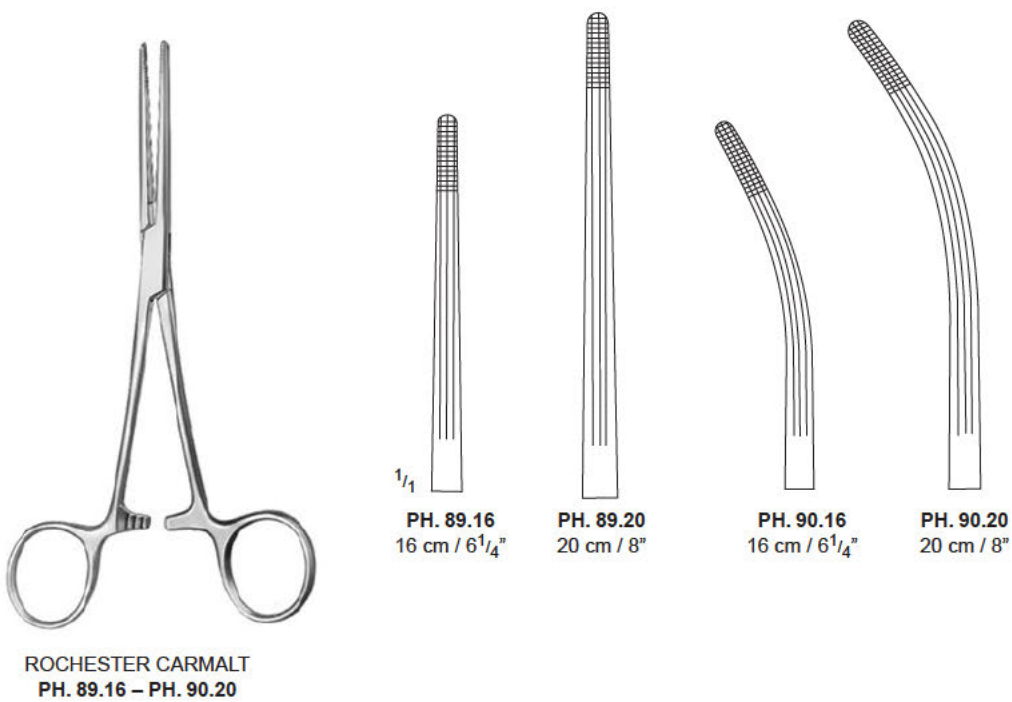
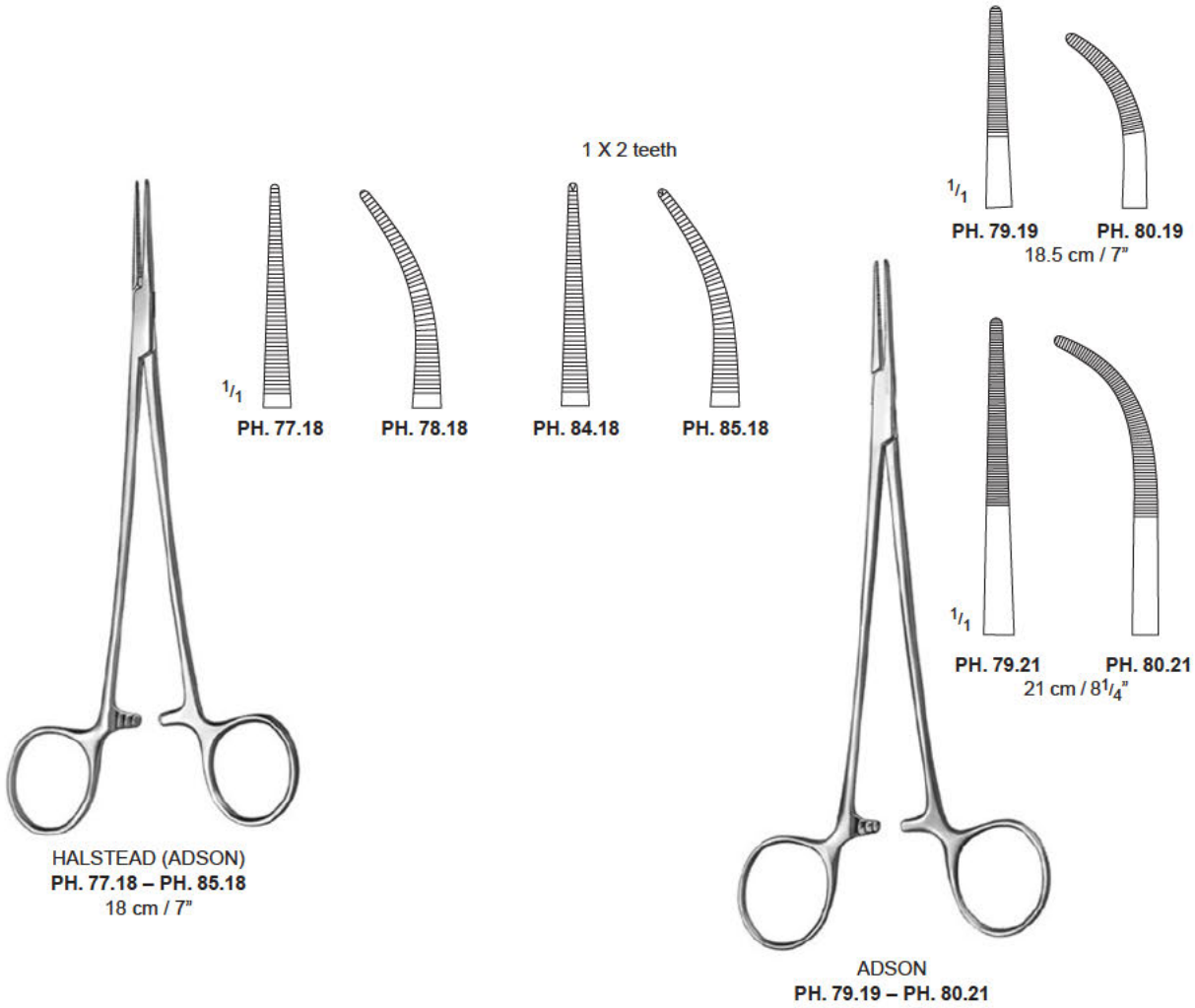

Peritoneal Clamp Forceps

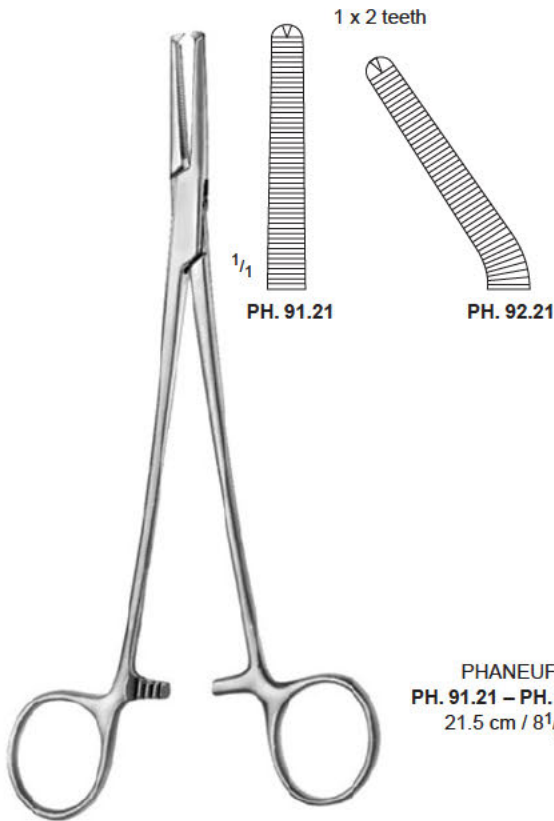

PHANEUF
 PH. 91.21 – PH. 92.21
 21.5 cm / 8½"

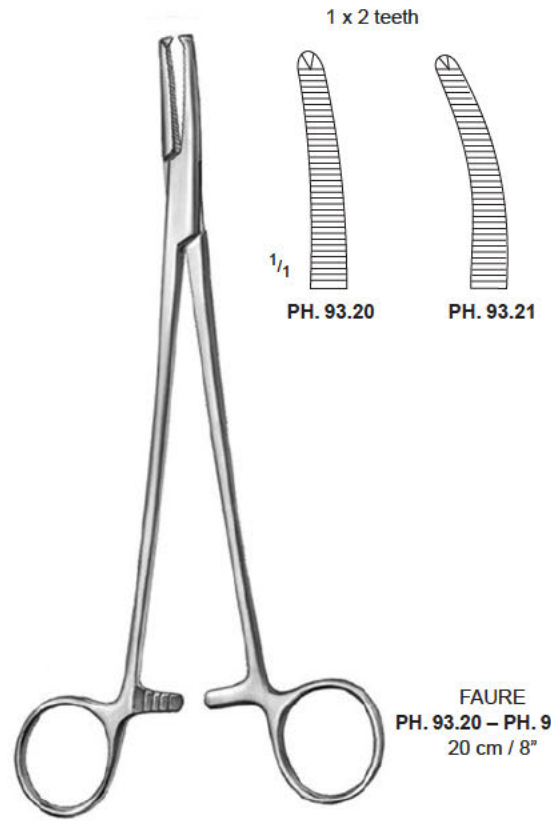

FAURE
 PH. 93.20 – PH. 93.21
 20 cm / 8"

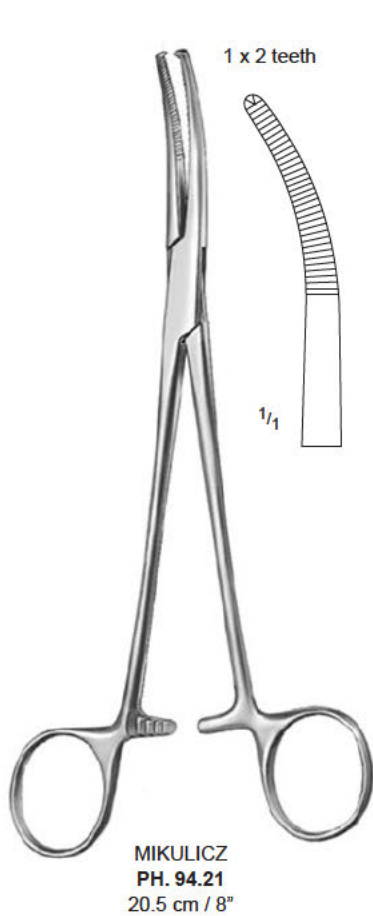

MIKULICZ
 PH. 94.21
 20.5 cm / 8"

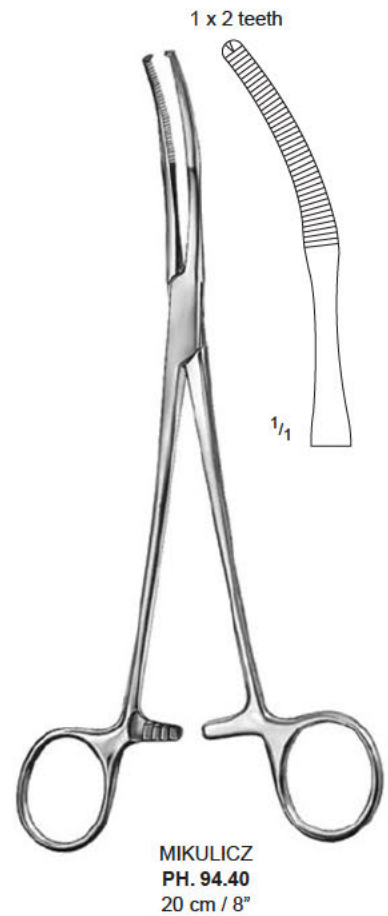

MIKULICZ
 PH. 94.40
 20 cm / 8"

Artery Forceps, Dissecting and Ligature Forceps

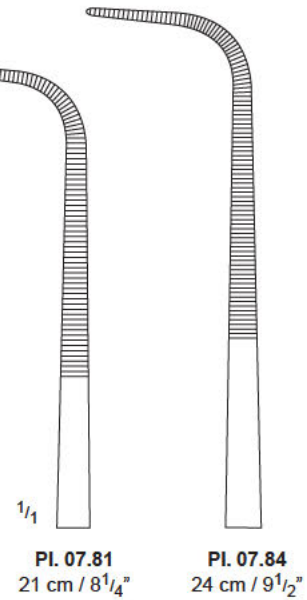
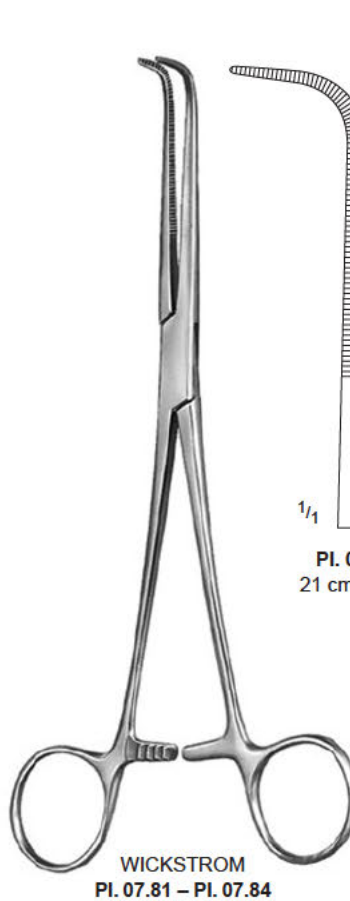
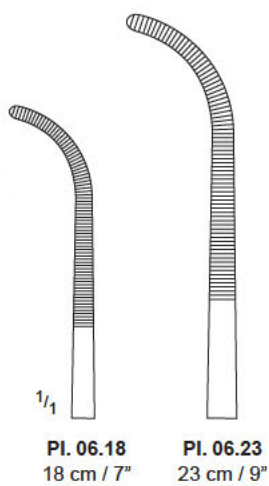
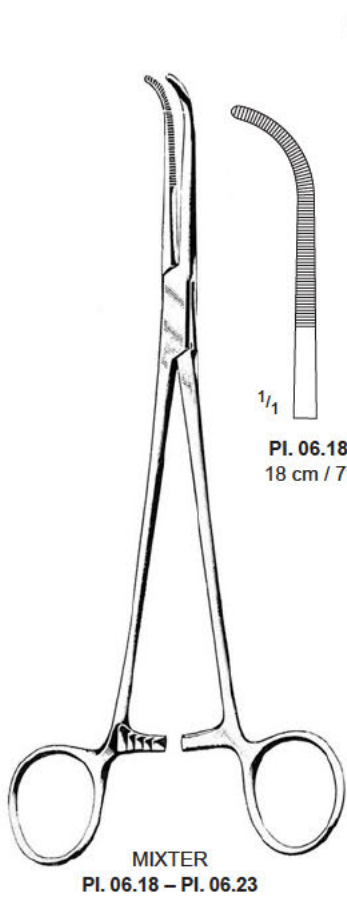
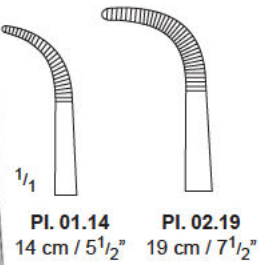
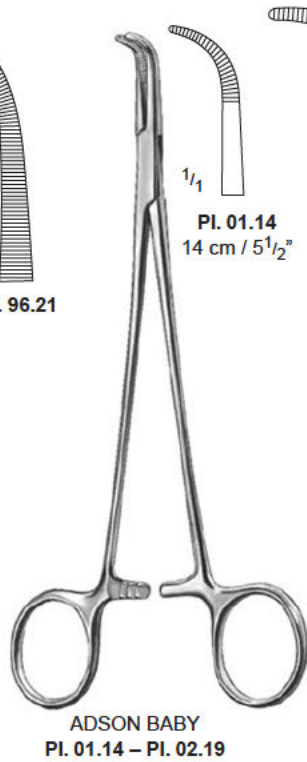
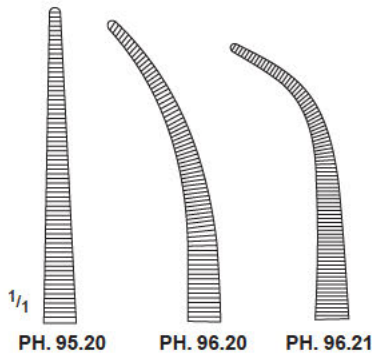
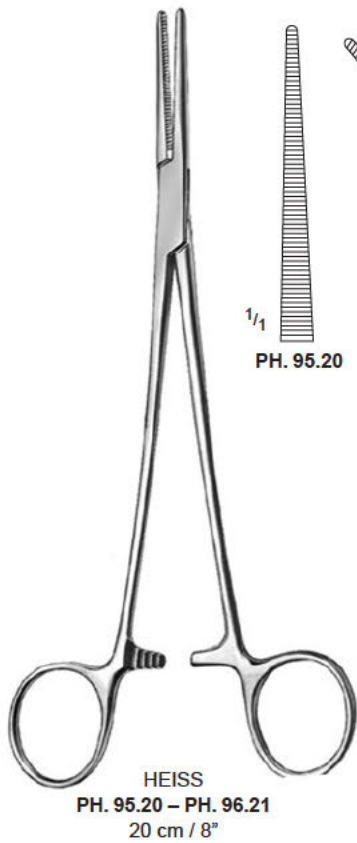

Artery Forceps, Dissecting and Ligature Forceps, Bronchus and Gall Duct Clamps

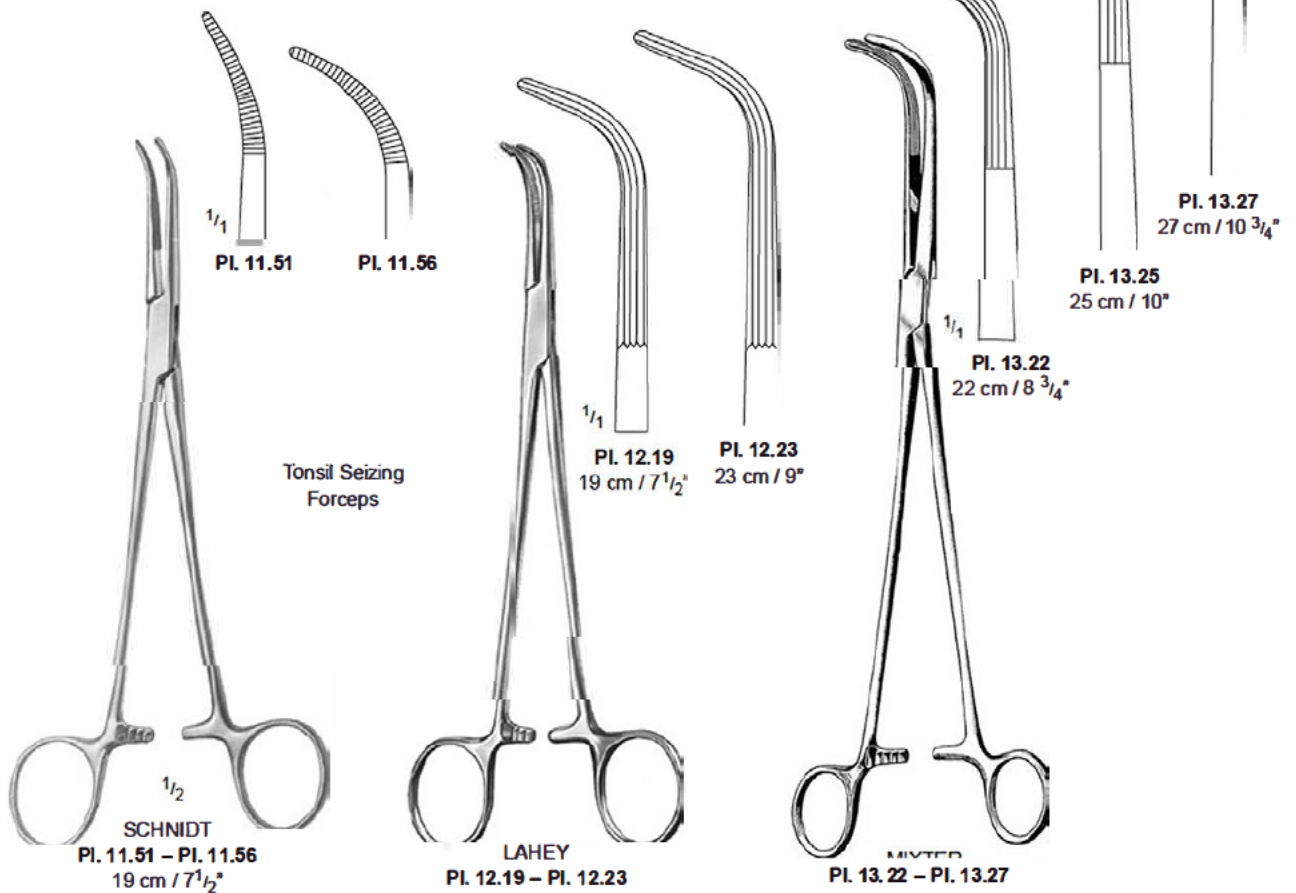
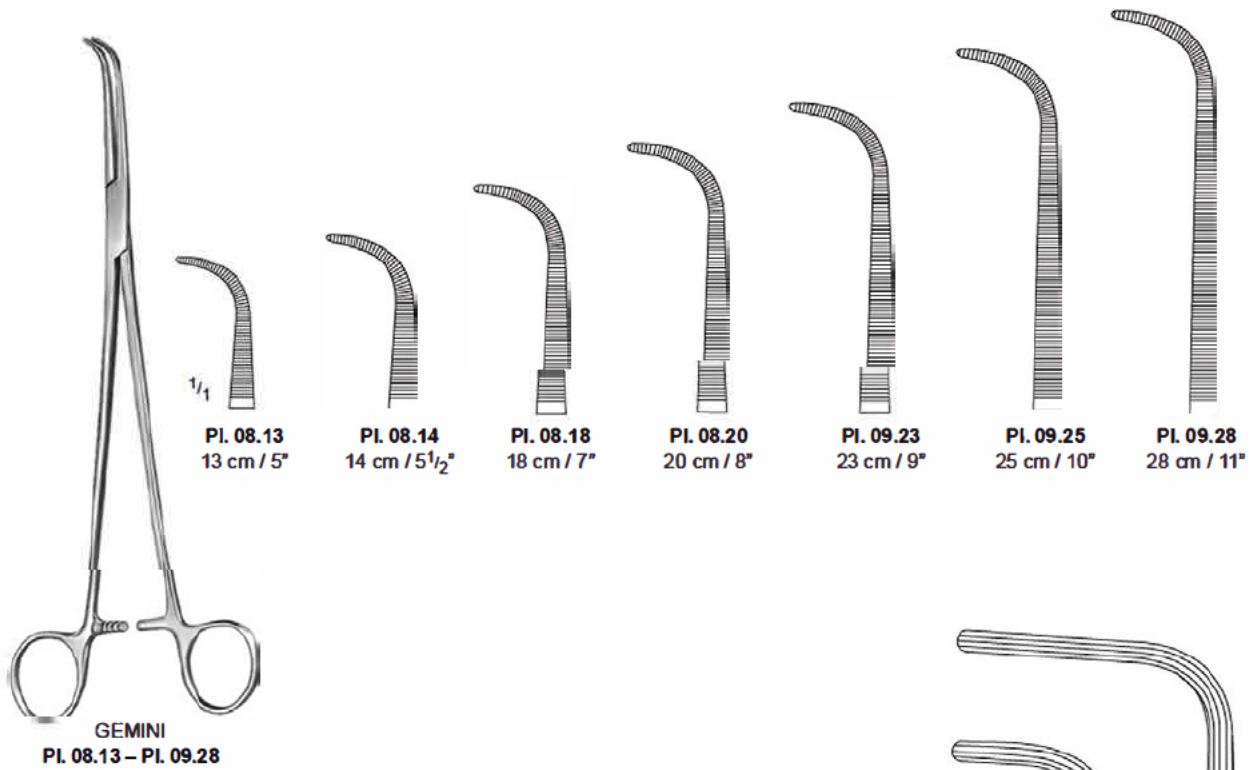

Tissue and Organ Holding Forceps

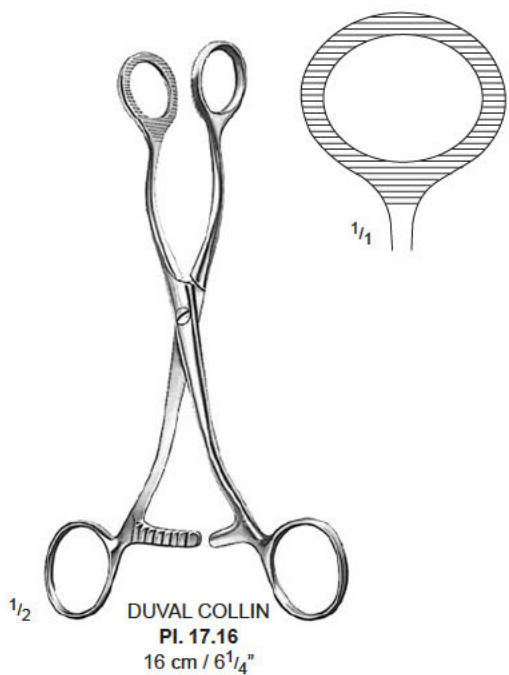
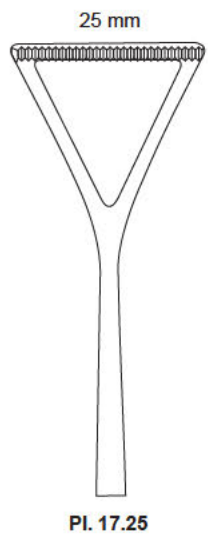
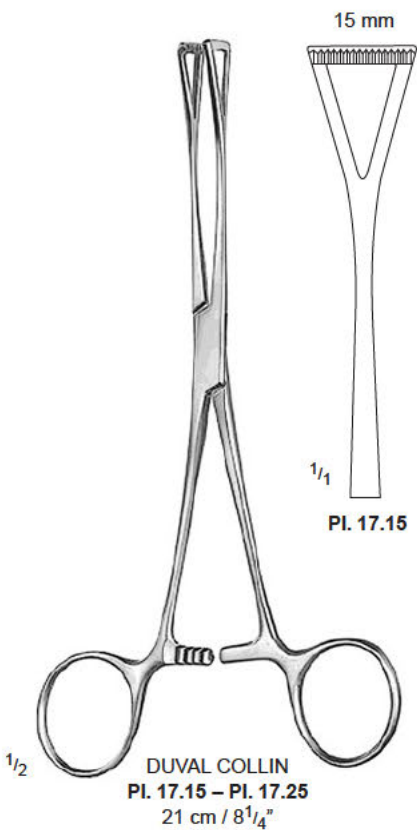
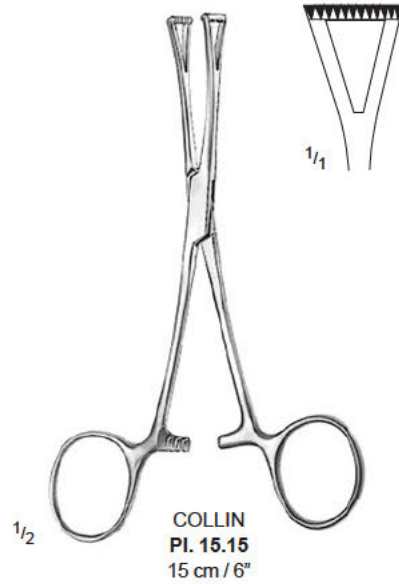
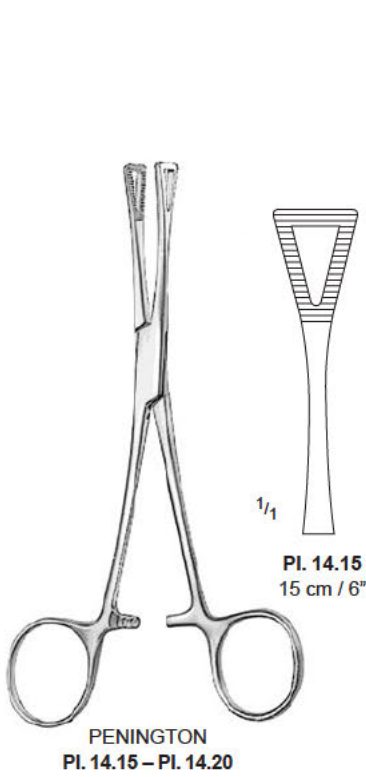

Towel Clamps



JONES
PI. 20.09
9 cm / 3 1/2"



SCHAEFFEL
PI. 21.09
9 cm / 3 1/2"



BACKHAUS
PI. 25.08 – 8.5 cm / 3 1/4"
PI. 25.10 – 10.5 cm / 4 1/4"
PI. 26.13 – 13 cm / 5"
PI. 26.15 – 15 cm / 6"



BACKHAUS-ROEDER
PI. 28.13 – 13 cm / 5"
PI. 28.15 – 15 cm / 6"



BALL & SOCKET
PI. 30.13 – 13 cm / 5"
PI. 30.15 – 15 cm / 6"



LANE
PI. 33.15 – 15 cm / 6"
PI. 33.18 – 18 cm / 7"
PI. 33.20 – 20 cm / 8"

Tubing Clamps

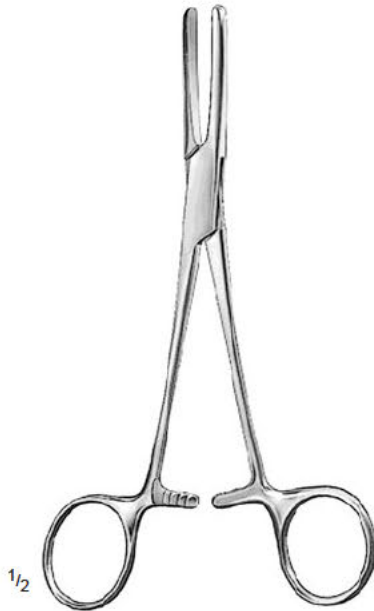

PRESBYTARIAN HOSPITAL
 Pl. 34.16 – Pl. 34.20

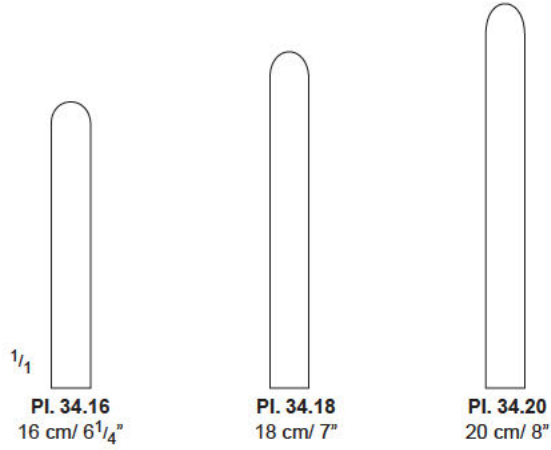

SCHOENBERG
 Pl. 35.16 – Pl. 35.20

