

# Innovative Solutions in Medical Instruments

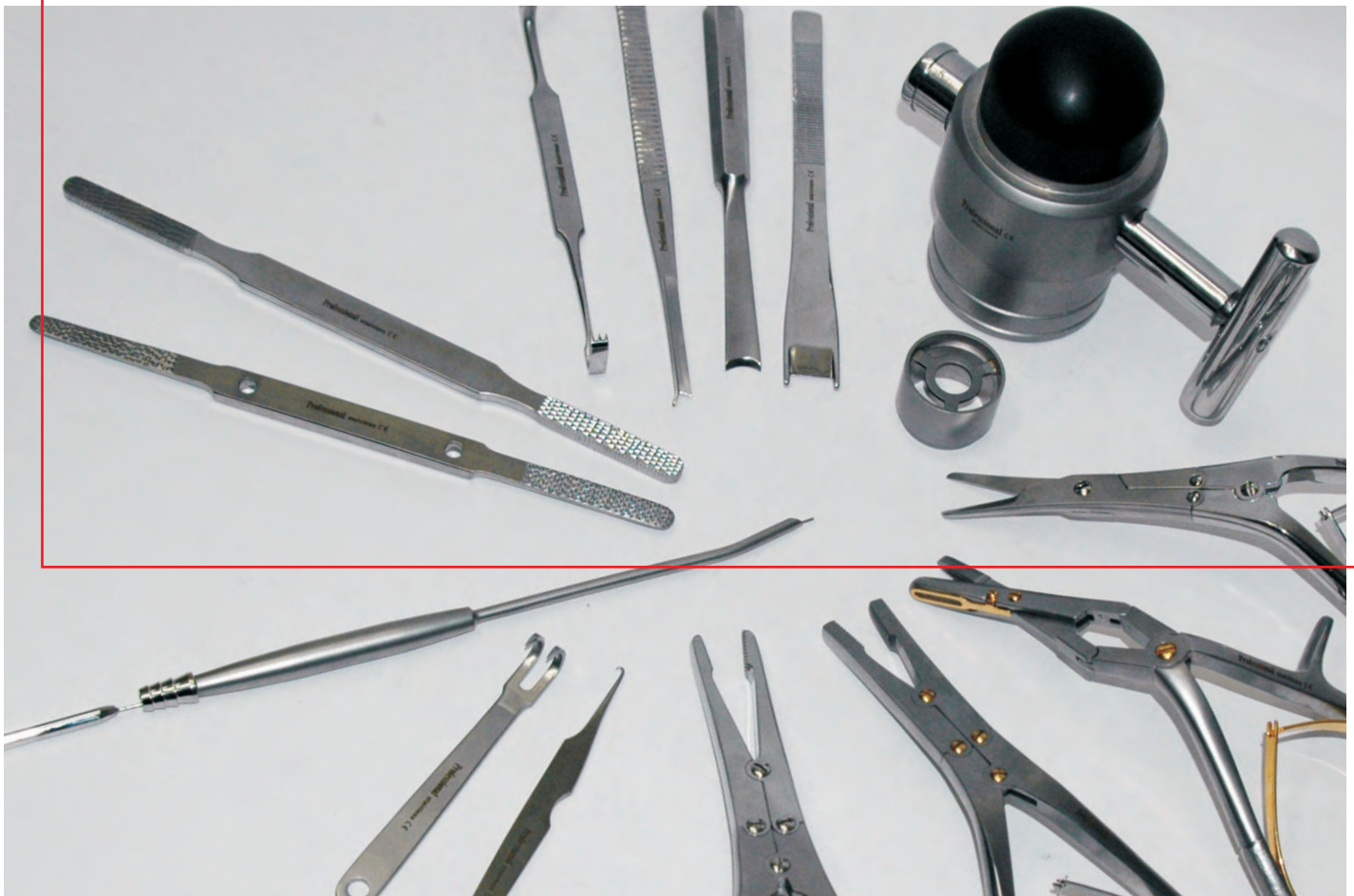

Plastic Surgery  
Cirugia Plástica  
Chirurgie plastique  
Chirurgia plastica

## Surgical-i

Precision | Performance | Innovation

Plastic Surgery  
Cirugia Plástica  
Chirurgie plastique  
Chirurgia plastica

**Marking and Measuring Instruments**  
Instrumentos para marcar y medir  
Instruments à mesurer et marquer  
Strumenti per marcare e misurare

---



## Marking and Measuring Instruments

Instrumentos para marcar y medir

Instrumenti à mesurer et marquer

Strumenti per marcare e misurare



**PA-37.15**  
15 cm / 6"



**PA-38.10**  
24 cm / 9½"



**PA-38.30**  
13 cm / 5¼"



**PA-38.40**  
10 cm / 4"



**PA-38.41**  
11 cm / 4¼"

**PA-37.20**  
20 cm / 8"

**PA-37.30**  
30 cm / 11¾"

**PA-37.50**  
50 cm / 19¾"



**JOSEPH**  
**PAN-30.47**  
17 cm / 6¾"



**JOSEPH**

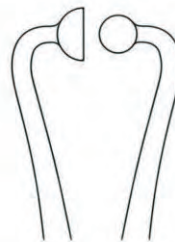

**PAN-30.12**  
12 cm / 4¾"



**PAN-30.14**  
14.5 cm / 5¾"



**KRETSCHMER**  
**PAN-84.00**



**KRETSCHMER**  
**PAN-84.05**  
15 mm



# Marking and Measuring Instruments

Instrumentos para marcar y medir

Instrumente à mesurer et marquer

Strumenti per marcare e misurare



**PA-38.44**  
19.5 cm / 7¾"



GUBISCH

**PA-39.02**  
Pen

**PA-39.01**  
13 cm / 5 1/8"  
Pen Holder



CASTROVIEJO  
**PAB-82.32**  
7 cm / 2¾"



CASTROVIEJO  
**PAB-82.41**  
9 cm / 3¾"

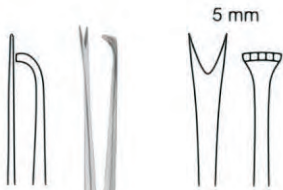

PITANGUY  
**PAN-64.30**  
16 cm / 6¼"



CASTROVIEJO EPKER  
**PAB-82.42**  
18 cm / 7 1/8"



CASTROVIEJO EPKER  
**PAB-82.43**  
18 cm / 7 1/8"

**Scissors**

Tijeras

Ciseaux

Forbici

---



## Delicate Dissecting Scissors

Tijeras finas para disección

Ciseaux délicats pour dissection

Forbici delicate per dissezione



SurgiNOR Supercut scissors with their uniquely ground edges have with ultimate cutting efficiency. The special micro serrations in conjunction with the uniquely ground edges ensure precise, fine and minimally traumatising cuts. All our well-known models such as Metzenbaum, Mayo or Iris scissors are supplied with the supercut finish. Professional supercut scissors have a gold-coloured screw for ease of identification.

The range of supercut scissors from PROFESSIONAL comprises all models used routinely by surgeons: scissors for delicate and extremely delicate dissecting, e.g. Iris and Micro, models according to Metzenbaum in all possible lengths and designs, e.g. in a slim version for especially fine cutting to name but a few.

The supercut scissors can also be supplied with "TC" welded cutting edges of solid tungsten carbide alloy. The junction between the steel of the scissors and the tungsten carbide is seamless and homogenous. The welded cutting edges of solid tungsten carbide alloy guarantee excellent cutting quality and long life-span.

### Identification:

PROFESSIONAL TC scissors:  
gold-coloured rings



PROFESSIONAL supercut scissors:  
one shaft completely gold plated



PROFESSIONAL supercut plus line scissors:  
one shaft completely gold plated and  
one ring gold plated



**Delicate Dissecting Scissors**  
 Tijeras finas para disección  
 Ciseaux délicats pour dissection  
 Forbici delicate per dissezione



standard  
 supercut  
 TC  
 supercut plus

IRIS



9cm/3 1/2"  
**PC-01.09**



10.5cm/4 1/4"  
**PC-01.10**  
**PC-01.110**



11.5cm/4 1/2"  
**PC-01.11**  
**PC-01.111**  
**PC-05.61**  
**PC-05.161**



12.5cm/5"  
**PC-01.12**



supercut  
 TC  
 supercut plus

IRIS



straight  
 11.5 cm /4 1/2"  
**PC-01.171**  
**PC-05.71**  
**PC-05.171**



curved  
 11.5 cm /4 1/2"  
**PC-02.171**  
**PC-06.71**  
**PC-06.171**



MICRO IRIS

standard  
 supercut



straight  
 9 cm /3 1/2"  
**PC-03.30**



curved  
 9 cm /3 1/2"  
**PC-04.30**  
**PC-04.130**



standard  
 supercut  
 TC  
 supercut plus

IRIS



9cm/3 1/2"  
**PC-02.09**



10.5cm/4 1/8"  
**PC-02.10**  
**PC-02.110**



11.5cm/4 1/2"  
**PC-02.11**  
**PC-02.111**  
**PC-06.61**  
**PC-06.161**



12.5cm/5"  
**PC-02.12**  
**PC-02.112**

## Delicate Dissecting Scissors

Tijeras finas para disección

Ciseaux délicats pour dissection

Forbici delicate per dissezione



STEVENS

standard

10 cm / 4"  
PC-09.70



10 cm / 4"  
PC-09.71



10 cm / 4"  
PC-10.70



10 cm / 4"  
PC-10.71



STEVENS

standard  
supercut



11.5 cm / 4½"  
PC-10.12  
PC-10.112



11.5 cm / 4½"  
PC-10.13  
PC-10.113



STEVENS

standard  
supercut

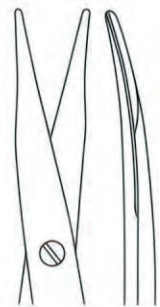

13 cm / 5 1/8"  
PC-10.15  
PC-10.115



LEXER BABY

standard  
TC

10 cm / 4"  
PC-11.10  
PC-13.60



10 cm / 4"  
PC-12.10  
PC-13.61



KNAPP

standard  
supercut  
TC

12.5cm / 5"  
PC-11.12  
PC-11.112  
PC-12.62



12.5cm / 5"  
PC-12.12  
PC-12.112  
PC-13.62



**Delicate Dissecting Scissors**  
 Tijeras finas para disección  
 Ciseaux délicats pour dissection  
 Forbici delicate per dissezione



KNAPP

standard  
supercut

12 cm / 4¾"  
PC-11.32  
PC-11.132



12 cm / 4¾"  
PC-12.32  
PC-12.132



12 cm / 4¾"  
PC-11.52



12 cm / 4¾"  
PC-12.52



KNAPP

standard

10 cm / 4"  
PC-11.70



10 cm / 4"  
PC-12.70



standard

9.5cm / 5"  
PC-12.90



standard  
supercut  
TC

12.5cm / 5"  
PAB-196.42  
PAB-196.142  
PC-13.62



12.5cm / 5"  
PAB-196.43  
PAB-196.143  
PC-13.63



## Delicate Dissecting Scissors

Tijeras finas para disección

Ciseaux délicats pour dissection

Forbici delicate per dissezione



MAYO

standard  
supercut  
TC  
supercut plus

14 cm / 5½"  
**PC-24.14**  
**PC-24.114**  
**PC-24.64**  
**PC-24.164**

14 cm / 5½"  
**PC-25.14**  
**PC-25.114**  
**PC-25.64**  
**PC-25.164**

17 cm / 6¾"  
**PC-24.17**  
**PC-24.117**  
**PC-24.67**  
**PC-24.167**

17 cm / 6¾"  
**PC-25.17**  
**PC-25.117**  
**PC-25.67**  
**PC-25.167**



MAYO STILLE

standard  
supercut  
TC  
supercut plus

16 cm / 6¼"  
**PC-30.15**  
**PC-30.115**  
**PC-31.65**  
**PC-31.165**

16 cm / 6¼"  
**PC-30.17**  
**PC-30.117**  
**PC-31.67**  
**PC-31.167**



**Delicate Dissecting Scissors**  
 Tijeras finas para disección  
 Ciseaux délicats pour dissection  
 Forbici delicate per dissezione



MAYO LEXER

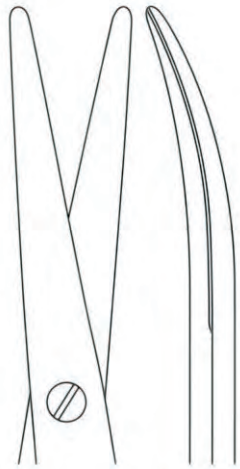

16.5 cm / 6½"  
 supercut **PC-32.187**  
 TC **PC-32.97**  
 supercut plus **PC-32.197**



LEXER

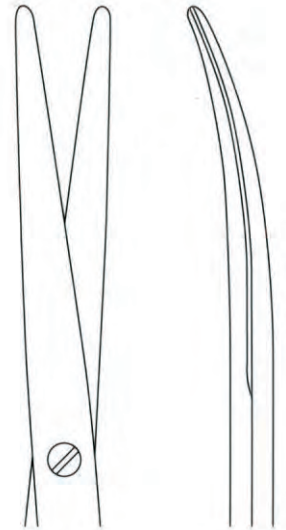

16 cm / 6¼"  
 standard **PC-32.86**  
 supercut **PC-32.116**  
 TC **PC-34.96**  
 supercut plus **PC-34.196**

16 cm / 6¼"  
**PC-32.17**  
**PC-32.117**  
**PC-35.96**  
**PC-35.196**



BABY METZENBAUM

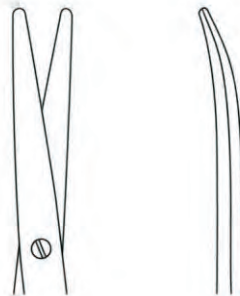

11.5 cm / 4½"  
 standard **PC-36.11**  
 supercut **PC-36.111**  
 TC **PC-36.61**  
 supercut plus **PC-36.161**

11.5 cm / 4½"  
**PC-37.11**  
**PC-37.111**  
**PC-37.61**  
**PC-37.161**

## Delicate Dissecting Scissors

Tijeras finas para disección

Ciseaux délicats pour dissection

Forbici delicate per dissezione



standard  
supercut  
TC  
supercut plus

METZENBAUM



14 cm / 5½"  
PC-36.14  
PC-36.114  
PC-36.64  
PC-36.164



18 cm / 7 1/8"  
PC-38.18  
PC-38.118  
PC-38.68  
PC-38.168



20 cm / 8"  
PC-38.20  
PC-38.120  
PC-38.70  
PC-38.170



standard  
supercut  
TC  
supercut plus

BABY METZENBAUM

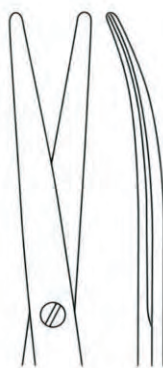

14 cm / 5½"  
PC-37.14  
PC-37.114  
PC-37.64  
PC-37.164



15 cm / 6"  
PC-37.15  
PC-37.115  
PC-39.68  
PC-39.168



18 cm / 7 1/8"  
PC-39.18  
PC-39.118  
PC-39.70  
PC-39.170



20 cm / 8"  
PC-39.20  
PC-39.120

**Delicate Dissecting Scissors**  
 Tijeras finas para disección  
 Ciseaux délicats pour dissection  
 Forbici delicate per dissezione



MINI METZENBAUM

supercut



9 cm / 3½"  
**PC-36.109**



9 cm / 3½"  
**PC-37.109**



NELSON METZENBAUM

standard  
 supercut  
 TC  
 supercut plus



23 cm / 9"  
**PC-40.23**  
**PC-40.123**  
**PC-40.73**  
**PC-40.173**



26 cm / 10¼"  
**PC-40.26**  
**PC-40.126**



30 cm / 11¾"  
**PC-40.30**  
**PC-40.130**

## Delicate Dissecting Scissors

Tijeras finas para disección

Ciseaux délicats pour dissection

Forbici delicate per dissezione



NELSON METZENBAUM

standard  
supercut  
TC  
supercut plus

23 cm / 9"  
PC-41.23  
PC-41.123  
PC-41.73  
PC-41.173

26 cm / 10¼"  
PC-41.26  
PC-41.126  
PC-41.76  
PC-41.176

30 cm / 11¾"  
PC-41.30  
PC-41.130  
PC-41.80  
PC-41.180



METZENBAUM slim

standard  
supercut  
TC  
supercut plus

14 cm / 5½"  
PC-42.14  
PC-42.114  
PC-42.64  
PC-42.164

18 cm / 7 1/8"  
PC-44.18  
PC-44.118  
PC-44.68  
PC-44.168

20 cm / 8"  
PC-44.20  
PC-44.120  
PC-44.70  
PC-44.170

23 cm / 9"  
PC-44.23  
PC-44.123  
PC-44.73  
PC-44.173

**Delicate Dissecting Scissors**  
 Tijeras finas para disección  
 Ciseaux délicats pour dissection  
 Forbici delicate per dissezione



METZENBAUM slim

standard  
 supercut  
 TC  
 supercut plus



14 cm / 5½"  
**PC-43.14**  
**PC-43.114**  
**PC-43.64**  
**PC-43.164**



18 cm / 7 1/8"  
**PC-45.18**  
**PC-45.118**  
**PC-45.68**  
**PC-45.168**



20 cm / 8"  
**PC-45.20**  
**PC-45.120**  
**PC-45.70**  
**PC-45.170**



23 cm / 9"  
**PC-45.23**  
**PC-45.123**  
**PC-45.73**  
**PC-45.173**



METZENBAUM slim

supercut



28.5 cm / 11¼"  
**PC-45.176**



28.5 cm / 11¼"  
**PC-45.178**

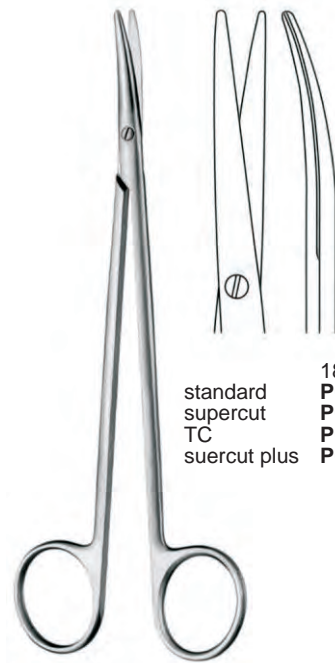

TOENNIS ADSON

standard  
 supercut  
 TC  
 suercut plus

18 cm / 7 1/8"  
**PC-50.18**  
**PC-50.118**  
**PC-50.68**  
**PC-50.168**

## Delicate Dissecting Scissors

Tijeras finas para disección

Ciseaux délicats pour dissection

Forbici delicate per dissezione



METZENBAUM

supercut  
TC  
supercut plus



18 cm / 7 1/8"  
PC-46.168  
PC-46.78  
PC-46.178



20 cm / 8"  
PC-46.170  
PC-46.80  
PC-46.180

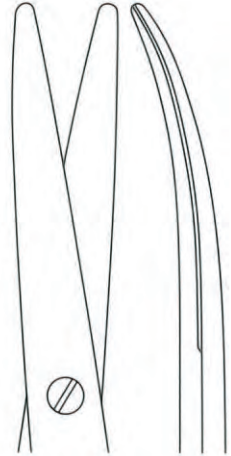

23 cm / 9"  
PC-46.173  
PC-46.83  
PC-46.183



METZENBAUM FREEMAN

supercut



18 cm / 7 1/8"  
PC-47.168



20 cm / 8"  
PC-47.170

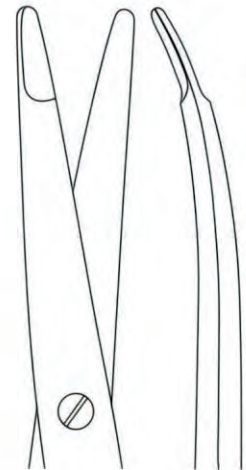

23 cm / 9"  
PC-47.173



**Delicate Dissecting Scissors**  
 Tijeras finas para disección  
 Ciseaux délicats pour dissection  
 Forbici delicate per dissezione



KELLY

standard  
 supercut  
 TC  
 supercut plus



16 cm / 6¼"  
**PC-46.16**  
**PC-46.116**  
**PC-46.66**  
**PC-46.166**



16 cm / 6¼"  
**PC-47.16**  
**PC-47.116**  
**PC-47.66**  
**PC-47.166**



BRUSER KELLY



16 cm / 6¼"  
**PC-48.116**

supercut



16 cm / 6¼"  
**PC-49.116**



SIEBERT

standard  
 TC



11.5cm / 4½"  
**PC-58.131**  
**PC-58.61**



11.5cm / 4½"  
**PC-58.132**  
**PC-58.62**



RAGNELL (KILNER)

standard  
 supercut  
 TC  
 supercut plus



13 cm / 5 1/8"  
**PC-59.13**  
**PC-59.113**  
**PC-59.63**  
**PC-59.163**



15 cm / 6"  
**PC-59.15**  
**PC-59.115**  
**PC-59.65**  
**PC-59.165**



18 cm / 7 1/8"  
**PC-59.18**  
**PC-59.118**  
**PC-59.68**  
**PC-59.168**



20 cm / 8"  
**PC-59.20**



## Delicate Dissecting Scissors

Tijeras finas para disección

Ciseaux délicats pour dissection

Forbici delicate per dissezione



GREENBERG PAR



supercut  
supercut plus

11.5 cm / 4 1/2"  
**PC-60.122**  
**PC-61.122**



standard  
supercut



11 cm / 4 3/8"  
**PC-64.111**  
**PC-64.111**



11 cm / 4 3/8"  
**PC-64.112**  
**PC-64.112**



JABELEY



standard  
supercut

13 cm / 5 1/8"  
**PC-64.113**  
**PC-64.113**



13 cm / 5 1/8"  
**PC-64.114**  
**PC-64.114**



JOSEPH



standard  
supercut

15cm / 6"  
**PC-65.114**  
**PC-65.114**



15cm / 6"  
**PC-66.114**  
**PC-66.114**

**Delicate Dissecting Scissors**  
 Tijeras finas para disección  
 Ciseaux délicats pour dissection  
 Forbici delicate per dissezione



PECK JOSEPH

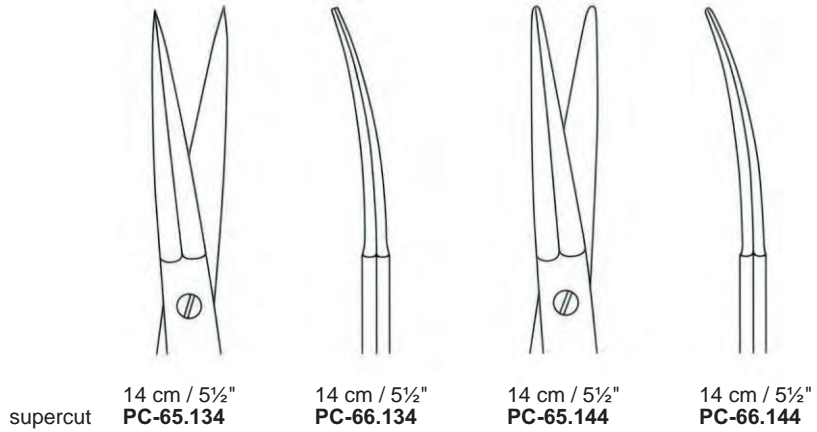

supercut 14 cm / 5½" **PC-65.134** 14 cm / 5½" **PC-66.134** 14 cm / 5½" **PC-65.144** 14 cm / 5½" **PC-66.144**



"slim"

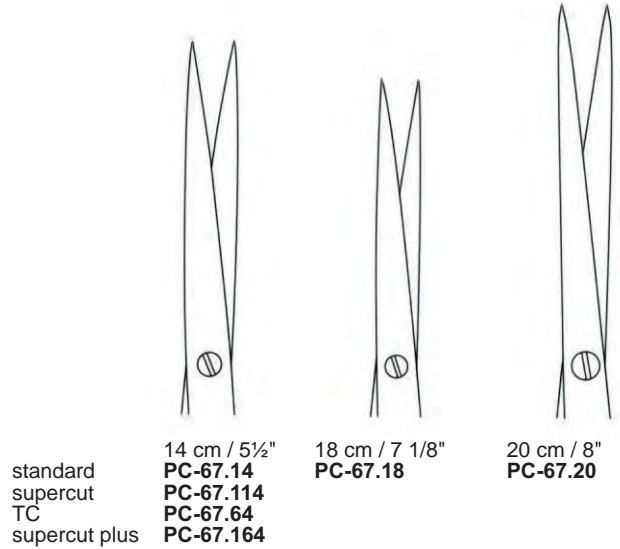

standard 14 cm / 5½" **PC-67.14**  
 supercut 18 cm / 7 1/8" **PC-67.18**  
 TC 20 cm / 8" **PC-67.20**  
 supercut plus **PC-67.164**



"slim"

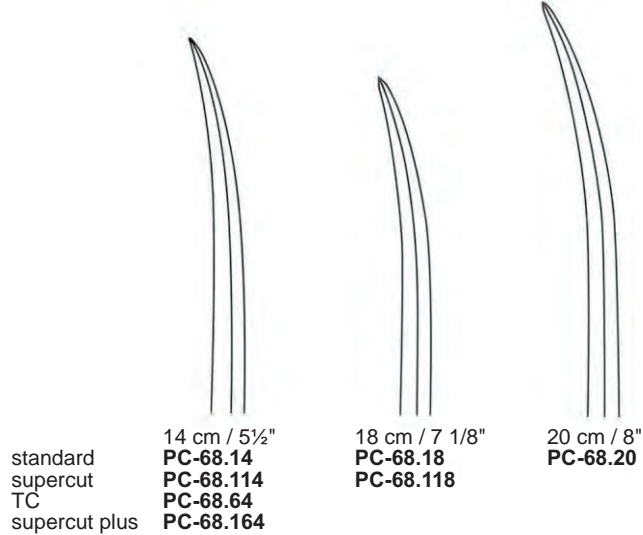

standard 14 cm / 5½" **PC-68.14**  
 supercut 18 cm / 7 1/8" **PC-68.18**  
 TC 20 cm / 8" **PC-68.20**  
 supercut plus **PC-68.164**

## Delicate Dissecting Scissors

Tijeras finas para disección

Ciseaux délicats pour dissection

Forbici delicate per dissezione



JAMESON

standard



15cm / 6"  
**PC-69.117**



18 cm / 7 1/8"  
**PC-70.118**



REYNOLDS (JAMESON)

standard



12 cm / 4 3/4"  
**PC-72.12**  
blunt



14 cm / 5 1/2"  
**PC-72.14**  
blunt



16 cm / 6 1/4"  
**PC-72.16**  
blunt



18 cm / 7 1/8"  
**PC-72.18**  
blunt



REYNOLDS (JAMESON)

standard  
supercut



12 cm / 4 3/4"  
**PC-73.12**  
**PC-73.112**  
blunt



14 cm / 5 1/2"  
**PC-73.14**



16 cm / 6 1/4"  
**PC-73.16**  
**PC-73.116**  
blunt



18 cm / 7 1/8"  
**PC-73.18**  
**PC-73.118**  
blunt

**Delicate Dissecting Scissors**  
 Tijeras finas para disección  
 Ciseaux délicats pour dissection  
 Forbici delicate per dissezione



FANOUS



supercut 16.5 cm / 6½"  
**PC-74.116**



16.5 cm / 6½"  
**PC-74.126**

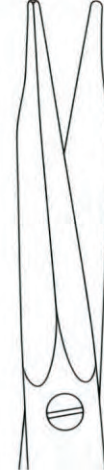

16.5 cm / 6½"  
**PC-74.120**



16.5 cm / 6½"  
**PC-74.130**



GORNEY

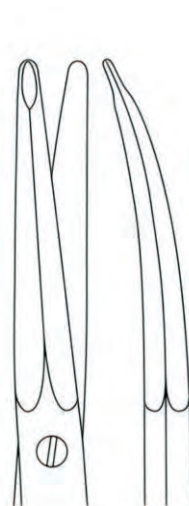

**GORNEY**  
 supercut 17cm / 6¾"  
**PC-77.127**  
 TC **PC-77.67**

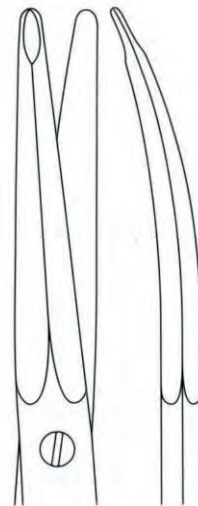

19 cm / 7½"  
**PC-77.129**  
**PC-77.69**

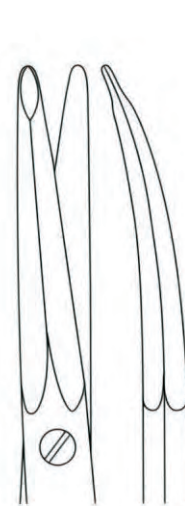

23 cm / 9"  
**PC-77.133**  
**PC-77.73**

**GORNEY-FREEMAN**

supercut 17cm / 6¾"  
**PC-80.117**  
 TC **PC-80.37**

19 cm / 7½"  
**PC-80.119**  
**PC-80.39**

23 cm / 9"  
**PC-80.123**  
**PC-80.43**

## Delicate Dissecting Scissors

Tijeras finas para disección

Ciseaux délicats pour dissection

Forbici delicate per dissezione

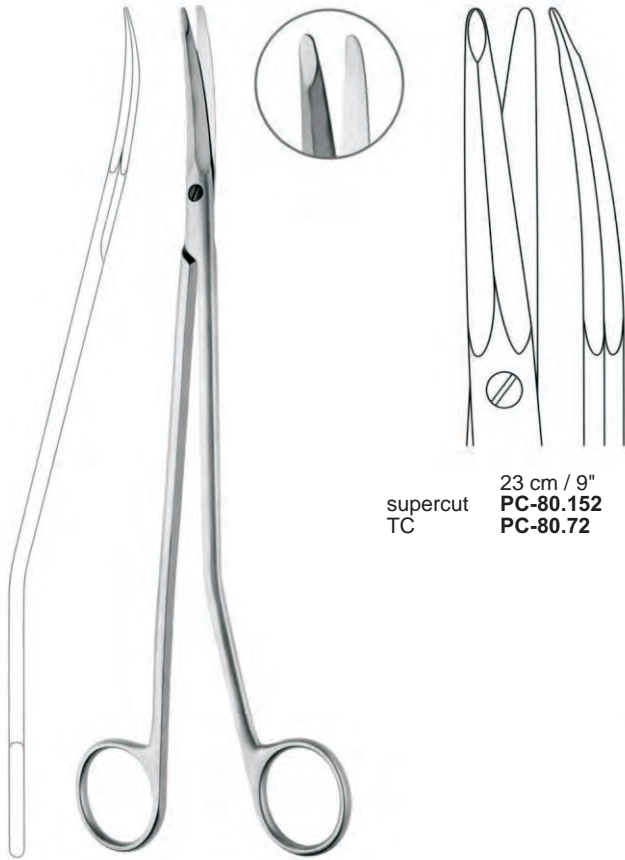

supercut  
TC

23 cm / 9"  
PC-80.152  
PC-80.72



GORNEY-FREEMAN



standard 12 cm / 4¾"  
PC-80.01

GORNEY-FREEMAN



KAYE

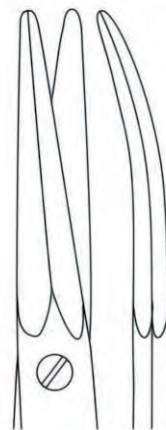

supercut  
TC

15 cm / 6"  
PC-81.115



17cm / 6¾"  
PC-81.117  
PC-81.37



**Delicate Dissecting Scissors**  
 Tijeras finas para disección  
 Ciseaux délicats pour dissection  
 Forbici delicate per dissezione



KAYE

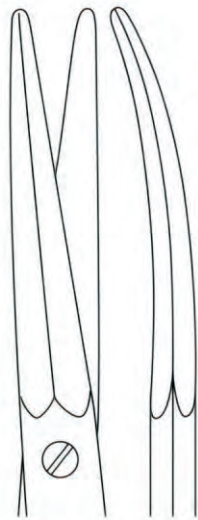

supercut  
TC

19 cm / 7 1/2"  
PC-81.119  
PC-81.39



23 cm / 9"  
PC-81.123  
PC-81.43



KAYE



supercut

11.5 cm / 4 1/2"  
PC-81.132



SOLZ

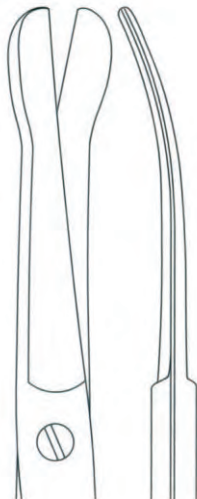

supercut  
20 cm / 8"  
PC-83.220



SOLZ

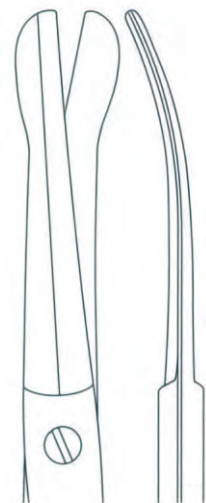

supercut  
20 cm / 8"  
PC-83.230

# Stitch Scissors

Tijeras para hilos

Ciseaux à fils

Forbici taglia-fili



FOX

standard  
supercut  
TC  
supercut plus



13 cm / 5 1/8"  
PC-90.13  
PC-90.113  
PC-90.63  
PC-90.163



13 cm / 5 1/8"  
PC-91.13  
PC-91.113  
PC-91.63  
PC-91.163



SPENCER

standard  
TC



9 cm / 3 1/2"  
PS-19.09



10.5 cm / 4 1/8"  
PS-20.10  
PS-20.60



12 cm / 4 3/4"  
PS-20.12  
PS-20.62



LITTAUER

standard



13 cm / 5 1/8"  
PS-21.13



KELLY

standard



15 cm / 6"  
PS-21.35



**Rhinoplasty Scissors**  
 Tijeras para ringoplastia  
 Ciseaux pour rhinoplastie  
 Forbici per rinoplastica



O'BRIEN

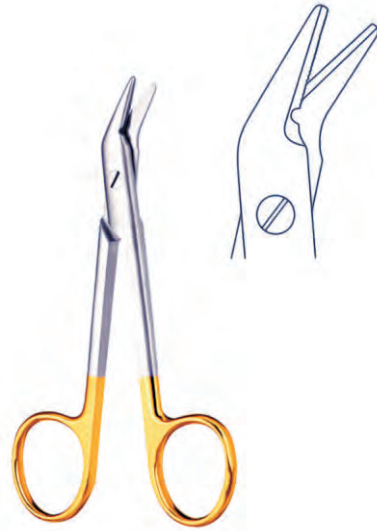
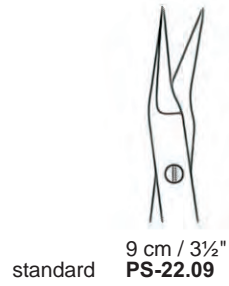

UNIVERSAL  
**PS-24.12**  
 12 cm / 4¾"



TC

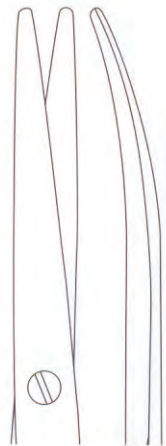

# Rhinoplasty Scissors

Tijeras para ringoplastia

Ciseaux pour rhinoplastie

Forbici per rinoplastica



DEAN

standard  
supercut



17 cm / 6 3/4"  
**PAK-25.17**  
**PAK-25.117**



HEYMANN

standard



20 cm / 8"  
**PAM-17.20**



HEYMANN

standard  
supercut



17 cm / 6 3/4"  
**PAM-17.17**



17 cm / 6 3/4"  
**PAM-17.21**



18 cm / 7 1/8"  
**PAM-17.122**

**Rhinoplasty Scissors**  
 Tijeras para ringoplastia  
 Ciseaux pour rhinoplastie  
 Forbici per rinoplastica



standard  
 supercut  
 supercut plus

FOMON



13 cm / 5 1/8"  
**PAM-50.13**  
**PAM-50.113**  
**PAM-50.163**



supercut

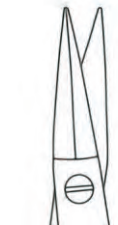

14 cm / 5 1/2"  
**PAM-50.14**

WALTER

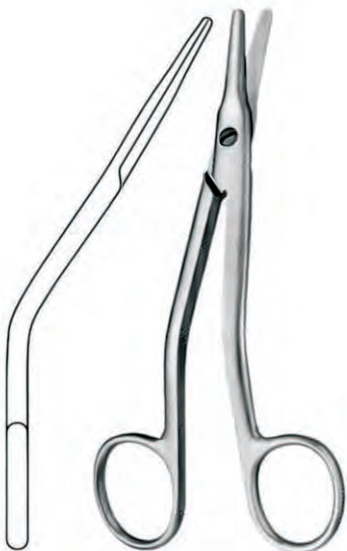

supercut  
 TC  
 supercut plus

WALTER COTTLE



16 cm / 6 1/4"  
**PAM-50.16**  
**PAM-50.77**  
**PAM-50.177**



standard  
 supercut  
 TC  
 supercut plus

COTTLE



16cm / 6 1/4"  
**PAM-51.16**  
**PAM-51.116**  
**PAM-51.36**  
**PAM-51.136**

# Rhinoplasty Scissors

Tijeras para ringoplastia

Ciseaux pour rhinoplastie

Forbici per rinoplastica



GIUNTA

TC



13.5 cm / 5 3/8"  
PAM-51.63



CONVERSE



standard 13.5 cm / 5 3/8"  
PAN-43.13



COTTLE MASING



standard 10 cm / 4"  
PAN-46.10



10 cm / 4"  
PAN-47.10



COTTLE



standard 11.5 cm / 4 3/4"  
PAN-49.12



CINELLI



standard 11 cm / 4 3/8"  
PAN-51.11



FOMON



standard 12.5 cm / 5"  
PAN-51.43

**Rhinoplasty Scissors**  
 Tijeras para ringoplastia  
 Ciseaux pour rhinoplastie  
 Forbici per rinoplastica



MCINDOE



standard 19 cm / 7½"  
**PAN-51.18**



AUFRICHT

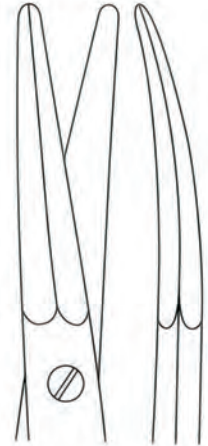

standard  
 supercut  
 TC  
 supercut plus  
 14 cm / 5½"  
**PAN-51.34**  
**PAN-51.134**  
**PAN-51.64**  
**PAN-51.164**



FOMON



standard 12.5 cm / 5"  
**PAN-51.43**



FANOUS



standard  
 supercut  
 13 cm / 5 1/8"  
**PAN-52.14**  
**PAN-52.114**



## Rhinoplasty Scissors

Tijeras para ringoplastia

Ciseaux pour rhinoplastie

Forbici per rinoplastica



COTTLE  
PAN-54.19  
18 cm / 7 1/8"

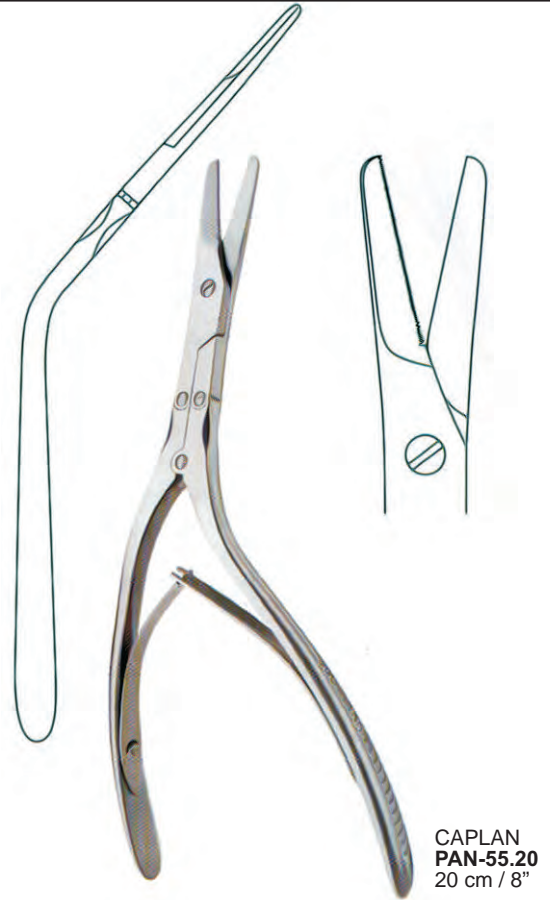

CAPLAN  
PAN-55.20  
20 cm / 8"



OBWEGESER



21cm / 8 1/4"  
PAN-56.31



21cm / 8 1/4"  
PAN-56.32



21cm / 8 1/4"  
PAN-56.33

**Micro Scissors**  
 Micro tijeras  
 Micro ciseaux  
 Micro forbici



standard

serrated cutting edges

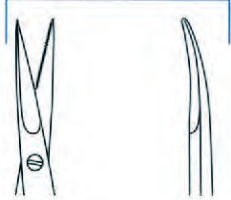

15 cm / 6"  
PD-01.22

15 cm / 6"  
PD-01.23

Vannas-type cutting edges

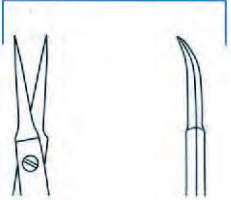

15 cm / 6"  
PD-01.30

15 cm / 6"  
PD-01.31

micro 2000



standard  
supercut



15 cm / 6"  
PD-01.20  
PD-01.120



15 cm / 6"  
PD-01.21  
PD-01.121

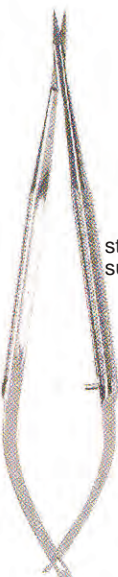

standard  
supercut



15 cm / 6"  
PD-01.74  
PD-01.174



15 cm / 6"  
PD-01.75

Vannas-type cutting edges

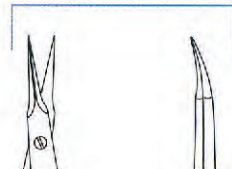

15 cm / 6"  
PD-01.76

15 cm / 6"  
PD-01.77

micro 2000

Round handle



standard



18 cm / 7¼"  
PD-07.20



18 cm / 7¼"  
PD-07.21



45°  
18 cm / 7¼"  
PD-07.25



45°  
18 cm / 7¼"  
PD-07.26



standard

23 cm / 9"  
PD-08.02



Round handle





**Scalpels**

Bisturies

Bistouris

Bisturi

**Dermatomes**

Dermatomos

Dermatomes

Dermatomi

**Instruments for Auricular Plastic**

Instrumentos para la otoplastia

Instrumentes pour l'otoplastie

Strumenti per l'otoplastica

---



PE-03.10  
Fig. 10



PE-03.11  
Fig. 11



PE-03.12  
Fig. 12



PE-03.32  
Fig. 12d



PE-03.15  
Fig. 15



PE-03.35  
Fig. 15c



PE-03.35  
Fig. 15c



PE-03.23  
Fig. 23



PE-04.03  
No.3  
12.5 cm / 5"



PE-05.07  
No.7  
16.5 cm / 6½"



PE-06.17  
No.7K  
12 cm / 4¾"



PE-07.13  
No.3L  
21 cm / 8¼"



PE-08.23  
No.3LA  
20.5 cm / 8"



PE-10.40  
15.5 cm / 6 1/8"

## Scalpels

Bisturies

Bistouris

Bisturi



**PE-10.45**  
22.5 cm / 9"



**PE-10.53**  
27 cm / 10<sup>3</sup>/<sub>4</sub>"



**PE-10.61**  
21 cm / 8<sup>1</sup>/<sub>4</sub>"



**PE-10.63**  
15.5 cm / 6 1/8"



**PE-10.64**  
21 cm / 8<sup>1</sup>/<sub>4</sub>"



**PE-10.92**  
Fig. 62



**PE-10.94**  
Fig. 64



**PE-10.95**  
Fig. 65



**PE-10.97**  
Fig. 67



**LANDOLT**  
**PE-10.86**  
21 cm / 8 1/4"



**LANDOLT**  
**PE-10.87**  
25 cm / 10"



**PE-10.90** 13 cm / 5 1/8"  
**PE-10.91** 15.5 cm / 6 1/8"

# Instruments for Auricular Plastic

Instrumentos para la otoplastia

Instruments pour l'otoplastie

Strumenti per l'otoplastica

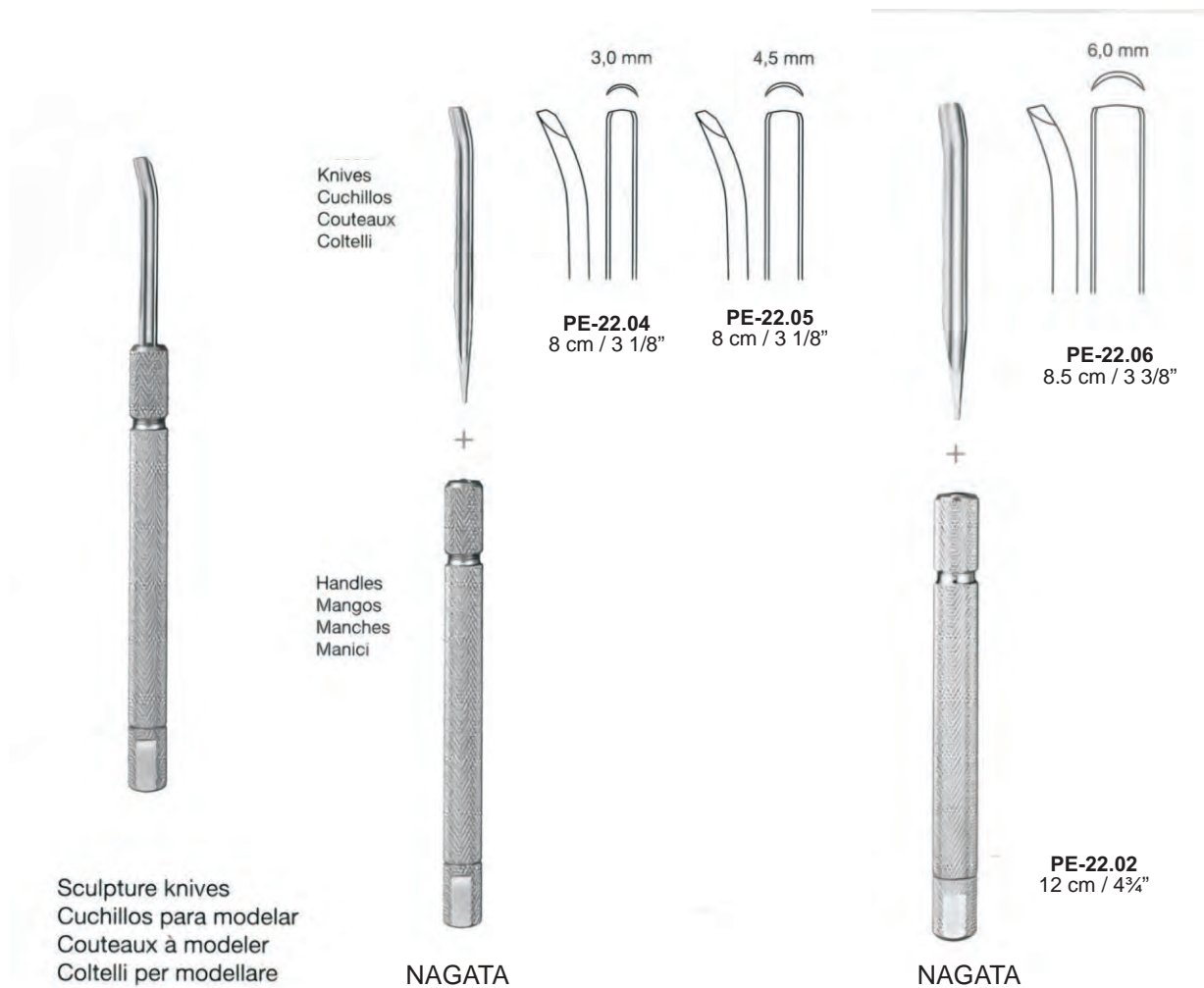



**HUMBY**  
**PE-30.30**  
 32 cm / 5½"



**PE-30.31**  
 15.5 cm / 6 1/8"



**WATSON**  
**PE-30.32**  
 30.5 cm / 12"



**SCHINK**  
**PE-30.50**  
 30 cm / 11¾"



**PE-30.51**  
 10 cm / 4"

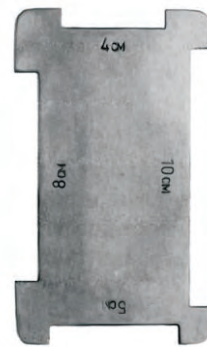

**PE-30.52**  
 13 x 7.5 cm



**SILVER**  
**PE-30.60**  
 19 cm / 7½"



**Forceps**  
Pinzas  
Pinces  
Pinze



**Delicate Forceps, Dressing and Tissue**  
 Pinzas finas, anatómicas y quirúrgicas  
 Pincés délictes, anatomiques et chirurgicales  
 Pinze delicate, anatomiche e chirurgiche



**PF-07.14**  
14.5 cm / 5¾"

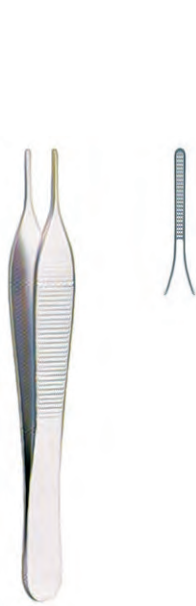

**ADSON PF-15.12**  
12 cm / 4¾"



**ADSON PF-15.62**  
12 cm / 4¾"



**ADSON PF-15.65**  
12.5 cm / 6"



**HUDSON-EWALD PF-16.01**  
12 cm / 4¾"



**HUDSON-EWALD PF-16.05**  
12 cm / 4¾"



**PF-16.12**  
12 cm / 4¾"



**PF-16.13**  
12 cm / 4¾"



**ADSON PF-16.15**  
15 cm / 6"

**Delicate Forceps, Dressing and Tissue**

Pinzas finas, anatómicas y quirúrgicas

Pinces délictes, anatomiques et chirurgicales

Pinze delicate, anatomiche e chirurgiche



ADSON  
PF-16.62  
12 cm / 4¾"



ADSON  
PF-16.65  
15 cm / 6"



PF-17.12  
12 cm / 4¾"



PF-19.12  
12 cm / 4¾"

MICRO ADSON



PF-18.15  
15 cm / 6"



PF-20.15  
15 cm / 6"

MICRO ADSON



PF-21.12



PF-21.13

ADSON BROWN  
12 cm / 4¾"

**Delicate Forceps, Dressing and Tissue**  
 Pinzas finas, anatómicas y quirúrgicas  
 Pincers délictes, anatomiques et chirurgicales  
 Pinze delicate, anatomiche e chirurgiche



**ADSON BROWN**  
**PF-22.72**  
 12 cm / 4¾"



**ADSON GRAEFE**  
**PF-23.82**  
 12 cm / 4¾"



**SEMKEN**



**PF-30.12**  
 12 cm / 4¾"



**PF-31.22**  
 12 cm / 4¾"



**PF-30.15**  
 15 cm / 6"



**PF-31.25**  
 15 cm / 6"



**SEMKEN**



**PF-32.12**  
 12 cm / 4¾"



**PF-33.22**  
 12 cm / 4¾"



**PF-32.15**  
 15 cm / 6"



**PF-33.25**  
 15 cm / 6"



**SEMKEN**  
**PF-34.32**  
 12 cm / 4¾"



**MCINDOE**  
**PF-35.15**  
 15 cm / 6"



**Delicate Forceps, Dressing and Tissue**

Pinzas finas, anatómicas y quirúrgicas

Pinces délictes, anatomiques et chirurgicales

Pinze delicate, anatomiche e chirurgiche

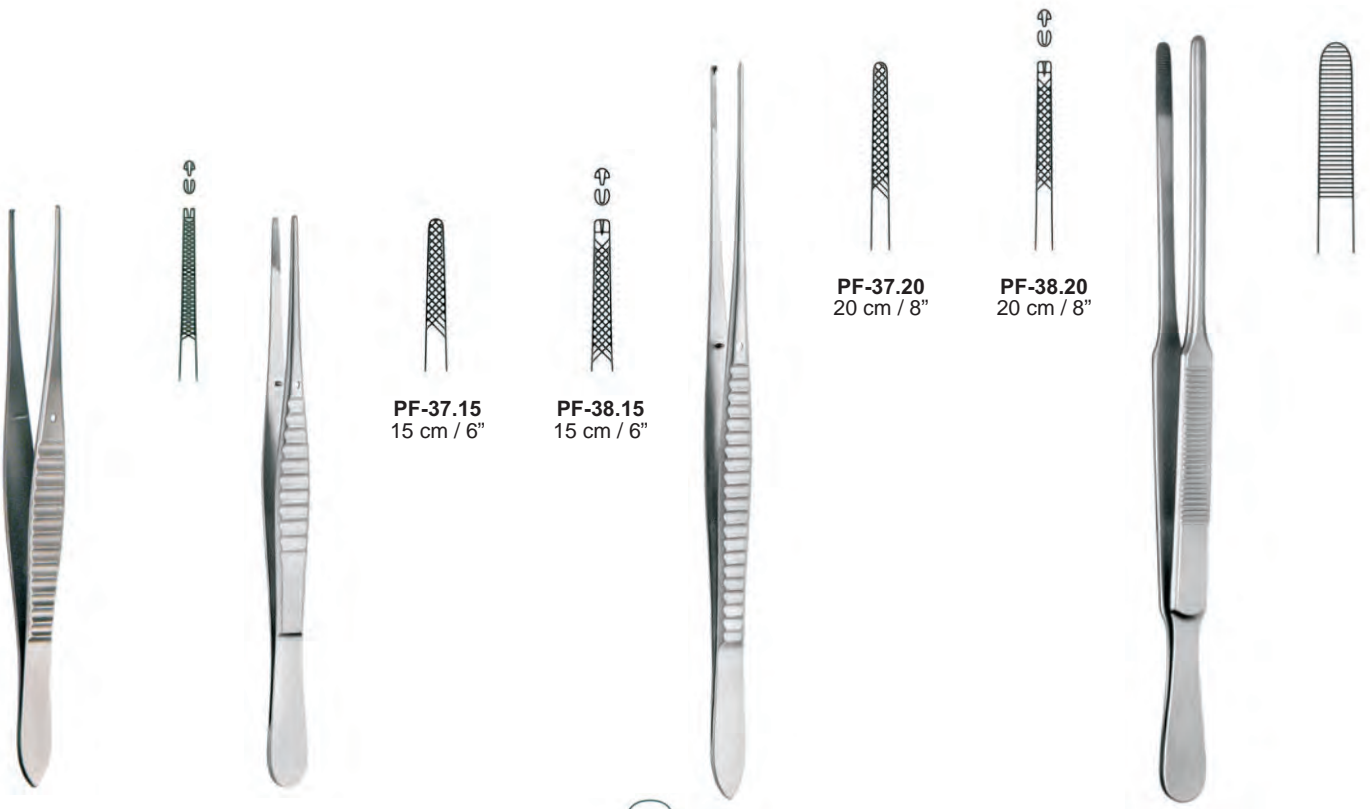

**GILLIES**  
**PF-36.85**  
15 cm / 6"

**WAUGH**

**PF-37.15**  
15 cm / 6"

**PF-38.15**  
15 cm / 6"

**PF-37.20**  
20 cm / 8"

**PF-38.20**  
20 cm / 8"

**PF-42.40**  
20 cm / 8"



**DEBAKEY**  
**PF-43.15**  
15 cm / 6"



**NELSON**

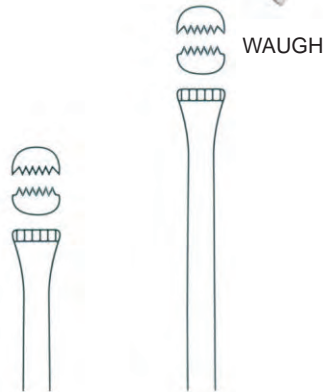

**PF-60.15**  
15 cm / 6"

**PF-60.23**  
23 cm / 9"



**WALTER**  
**PF-60.26**  
16 cm / 6¼"

**WALTER**  
**PF-60.36**  
16 cm / 6¼"

**Delicate Forceps, Dressing and Tissue**  
 Pinzas finas, anatómicas y quirúrgicas  
 Pincers délictes, anatomiques et chirurgicales  
 Pinze delicate, anatomiche e chirurgiche



**GRUENWALD**  
**PF-64.16**  
 16 cm / 6¼"



**TROELTSCH (WILDE)**  
**PF-70.13**  
 13 cm / 5"

**Suturing Forceps**  
 Pinzas para sutura  
 Pincers à suture  
 Pinze per sutura



0.3 mm



**PF-71.50**  
 12 cm / 4¾"

0.3 mm



**PF-71.51**

0.3 mm



**PF-71.52**

0.3 mm



**PF-71.53**

**PF-71.60**  
 15 cm / 6"

**PF-71.61**

**PF-71.62**

**PF-71.63**

**PF-71.70**  
 18 cm / 7 1/8"

**PF-71.71**

**PF-71.72**

**PF-71.73**



0.6 mm



**PF-71.84**  
 23 cm / 9"





## Tissue Grasping Forceps

Pinzas para agarrar tejidos

Pinces à saisir les tissus

Pinze per afferrare tessuti



WALTER  
PAB-57.18  
8 cm / 3 1/8"



COTTLE  
PAN-60.15  
15 cm / 6"



FOX



PAN-62.13  
13 cm / 5 1/8"



PAN-62.15  
15 cm / 6"



FOX  
PAN-64.15  
15 cm / 6"



FOX  
PAN-65.15  
15.5 cm / 6 1/8"



COTTLE  
PAN-66.15  
15 cm / 6"

**Hemostatic Forceps**  
Pinzas hemostáticas  
Pincas hémostatiques  
Pinze emostatiche

---





**PH-04.08**  
4.5 cm / 1 3/4"



**PH-04.12**  
5 cm / 2"



**PH-04.16**  
5.5 cm / 2 1/8"



**PH-04.28**  
4.5 cm / 1 3/4"



**PH-04.32**  
5 cm / 2"



**PH-04.36**  
5.5 cm / 2 1/8"

DIETHRICH

DIETHRICH



MOSQUITO



**PH-10.12**  
14 cm / 5 1/2"



**PH-11.12**  
14 cm / 5 1/2"



**PH-18.12**  
14 cm / 5 1/2"



**PH-19.12**  
14 cm / 5 1/2"



MOSQUITO



**PH-10.22**  
12.5 cm / 15"



**PH-13.22**  
12.5 cm / 15"



**PH-18.22**  
12.5 cm / 15"

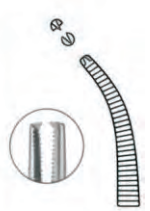

**PH-19.22**  
12.5 cm / 15"

**Hemostatic Forceps**  
 Pinzas hemostáticas  
 Pincas hémostatiques  
 Pinze emostatiche



MOSQUITO



**PH-14.42**  
12.5 cm / 5"



**PH-15.42**  
12.5 cm / 5"



MOSQUITO



**PH-18.42**  
12.5 cm / 5"



**PH-19.42**  
12.5 cm / 5"



MICRO JACOBSON  
(KOSHIMA)



**PH-18.52**  
12.5 cm / 5"



**PH-19.52**  
12.5 cm / 5"



HALSTED MOSQUITO



**PH-18.60**  
12.5 cm / 5"



**PH-19.60**  
12.5 cm / 5"



**PH-18.62**  
12.5 cm / 5"



**PH-19.62**  
12.5 cm / 5"



PROVIDENCE HOSPITAL

**PH-30.14**  
10 cm / 4"



**PH-31.14**  
10 cm / 4"



**PH-32.14**  
12.5 cm / 5"



**PH-33.14**  
12.5 cm / 5"



LERICHE

**PH-34.15**  
12.5 cm / 5"



**PH-35.15**  
12.5 cm / 5"



**PH-36.15**  
12.5 cm / 5"



**PH-37.15**  
12.5 cm / 5"

**Needle Holders**  
Porta-agujas  
Porte-aiguilles  
Portaghi

---







**COLLIER**  
**PJ-05.13**  
 13 cm / 5 1/8"

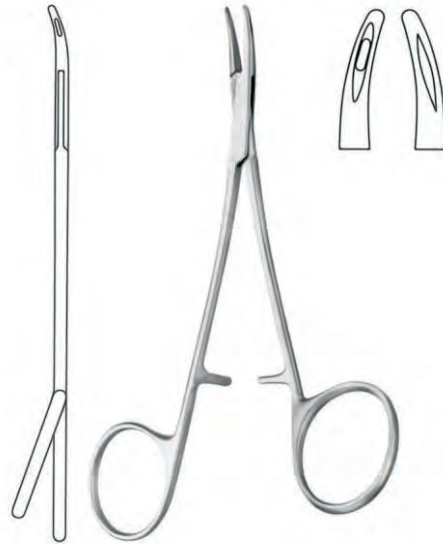

**CONVERSE**  
**PJ-06.15**  
 15 cm / 6"



**CONVERSE**  
**PJ-07.65**  
 15 cm / 6"



**NAGATA**

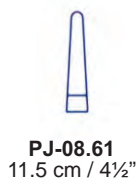

**PJ-08.61**  
 11.5 cm / 4 1/2"



**PJ-08.63**  
 13 cm / 5 1/8"

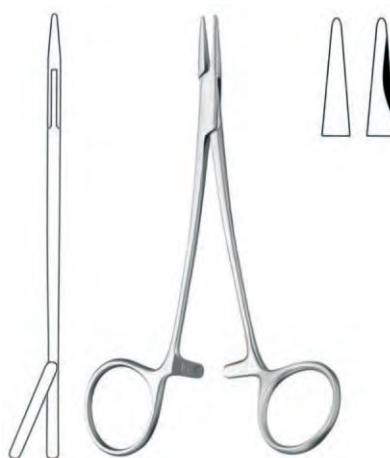

**NEIVERT**  
**PJ-09.12**  
 12.5 cm / 5"



**NEIVERT**  
**PJ-10.62**  
 12.5 cm / 5"

## Needle Holders

Porta-agujas

Porte-aiguilles

Portaghi



WRIGHT (DERF)  
PJ-12.12  
12.5 cm / 5"



GUBISCH  
PJ-13.61  
12.5 cm / 5"



WRIGHT (DERF)  
PJ-13.62  
12.5 cm / 5"



HALSEY  
PJ-14.13  
13.5 cm / 5 3/8"



HALSEY  
PJ-15.63  
13.5 cm / 5 3/8"



DERF CONVERSE  
PJ-17.82  
12.5 cm / 5"



CRILE WOOD



**PJ-34.15**  
15 cm / 6"



**PJ-21.18**  
18 cm / 7 1/8"



**PJ-21.20**  
20 cm / 8"



**PJ-21.23**  
23 cm / 9"



CRILE WOOD



**PJ-22.15**  
15 cm / 6"



**PJ-22.18**  
18 cm / 7 1/8"



**PJ-22.20**  
20 cm / 8"



**PJ-22.23**  
23 cm / 9"



**PJ-22.25**  
25 cm / 10"



**PJ-22.30**  
30 cm / 11 3/4"

## Needle Holders

Porta-agujas  
Porte-aiguilles  
Portaghi



MAYO HEGAR



**PJ-23.15**  
15 cm / 6"



**PJ-23.18**  
18 cm / 7 1/8"



**PJ-23.20**  
20 cm / 8"



**PJ-23.23**  
23 cm / 9"



**PJ-23.24**  
24 cm / 9 1/2"



MAYO HEGAR



**PJ-24.15**  
15 cm / 6"



**PJ-24.18**  
18 cm / 7 1/8"



**PJ-24.20**  
20 cm / 8"



**PJ-24.23**  
23 cm / 9"



**PJ-24.24**  
24 cm / 9 1/2"



**PJ-24.26**  
26 cm / 10 1/4"



**PJ-24.30**  
30 cm / 11 3/4"

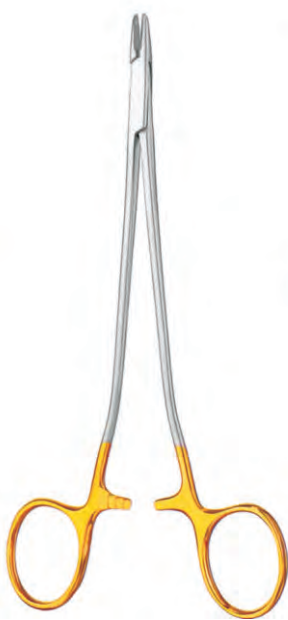

SENNING

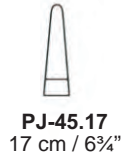

SENNING  
**PJ-46.17**  
 17 cm / 6¾"

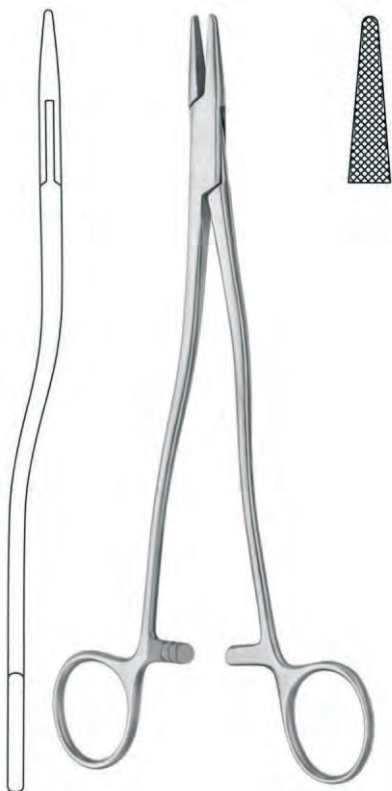

THOMSON WALKER  
 (BOZEMANN)  
**PJ-47.20**  
 20 cm / 8"

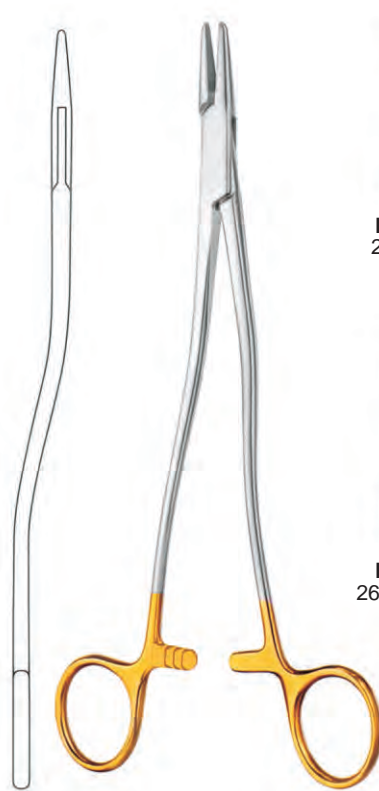

BOZEMANN  
 (WERTHEIM)

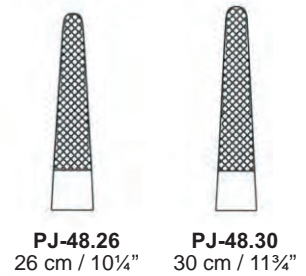
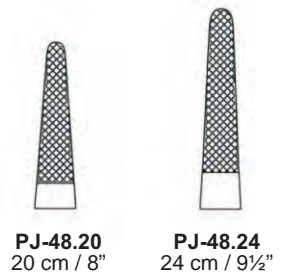

**Needle Holders**

Porta-agujas

Porte-aiguilles

Portaghi



**GILLIES SLIM  
PJ-53.14**  
14.5 cm / 5¾"



**GILLIES SLIM  
PJ-54.15**  
14.5 cm / 5¾"



**GILLIES  
PJ-55.15**  
15.5 cm / 6 1/8"

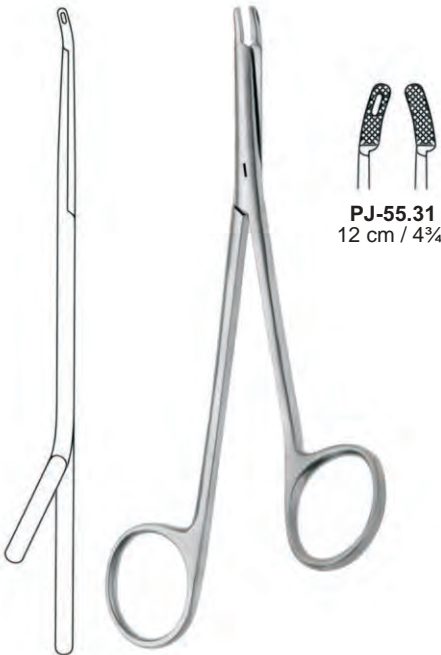

**OBWEGESER GILLIES**



**PJ-55.31**  
12 cm / 4¾"

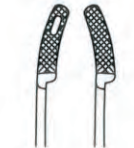

**PJ-55.34**  
14.5 cm / 5¾"



**PJ-55.37**  
17 cm / 6¾"



**OBWEGESER GILLIES  
PJ-55.58**  
16 cm / 6¼"





**GILLIES**  
**PJ-56.16**  
 15.5 cm / 6 1/8"



**MATHIEU**

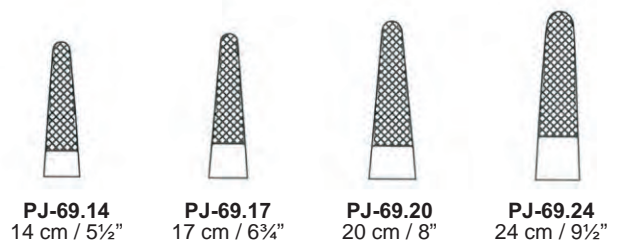

**PJ-69.14**  
 14 cm / 5 1/2"

**PJ-69.17**  
 17 cm / 6 3/4"

**PJ-69.20**  
 20 cm / 8"

**PJ-69.24**  
 24 cm / 9 1/2"



**COTTLE MASING**



**PAN-30.56**  
 a = 60 mm

























**PAN-30.59**  
 a = 90 mm



smooth

## Micro Needle Holders

Micro porta-agujas  
Micro porte-aiguilles  
Micro portaghi

							
	<p>a = 0.4 mm a = 0.4 mm</p>	<p>13 cm / 5 1/8" <b>PK-22.13</b></p>	<p>15 cm / 6" <b>PK-21.15</b> <b>PK-22.15</b></p>	<p>18 cm / 7 1/8" <b>PK-21.18</b> <b>PK-22.18</b></p>	<p>21 cm / 9" <b>PK-21.21</b> <b>PK-22.21</b></p>		
	<p>a = 0.5 mm a = 0.5 mm</p>			<p><b>PK-21.38</b> <b>PK-22.38</b></p>	<p><b>PK-21.41</b> <b>PK-22.41</b></p>		
							
		<p>a = 0.4 mm a = 0.4 mm</p>	<p>13 cm / 5 1/8" <b>PK-24.13</b></p>	<p>15 cm / 6" <b>PK-23.15</b> <b>PK-24.15</b></p>	<p>18 cm / 7 1/8" <b>PK-23.18</b> <b>PK-24.18</b></p>	<p>21 cm / 9" <b>PK-23.21</b> <b>PK-24.21</b></p>	
		<p>a = 0.5 mm a = 0.5 mm</p>	<p><b>PK-24.33</b></p>		<p><b>PK-23.38</b> <b>PK-24.38</b></p>	<p><b>PK-23.41</b> <b>PK-24.41</b></p>	
							
			<p>a = 0.4 mm a = 0.4 mm</p>	<p>13 cm / 5 1/8" <b>PK-32.13</b></p>	<p>15 cm / 6" <b>PK-31.15</b> <b>PK-32.15</b></p>	<p>18 cm / 7 1/8" <b>PK-31.18</b> <b>PK-32.18</b></p>	<p>21 cm / 9" <b>PK-31.21</b> <b>PK-32.21</b></p>
			<p>a = 0.5 mm a = 0.5 mm</p>			<p><b>PK-31.38</b> <b>PK-32.38</b></p>	<p><b>PK-31.41</b> <b>PK-32.41</b></p>
							
<p>a = 0.4 mm a = 0.4 mm</p>				<p>13 cm / 5 1/8" <b>PK-34.13</b></p>	<p>15 cm / 6" <b>PK-33.15</b> <b>PK-34.15</b></p>	<p>18 cm / 7 1/8" <b>PK-33.18</b> <b>PK-34.18</b></p>	<p>21 cm / 9" <b>PK-33.21</b> <b>PK-34.21</b></p>
<p>a = 0.5 mm a = 0.5 mm</p>				<p><b>PK-34.33</b></p>		<p><b>PK-33.38</b> <b>PK-34.38</b></p>	<p><b>PK-33.41</b> <b>PK-34.41</b></p>

**Wires and Wire Instruments**

Alambre y Instrumentos para alambre  
Fils et instruments pour fils métalliques  
Fili e strumenti per fili d'acciaio

**Elevators**

Elevadores  
Elévateurs  
Elevatori

**Mallets**

Martillos  
Maillets  
Martelli

---



**PM-08.18**  
 18.5 cm / 7¼"



**COTTLE**  
**PM-08.40**  
 19 cm / 7½"

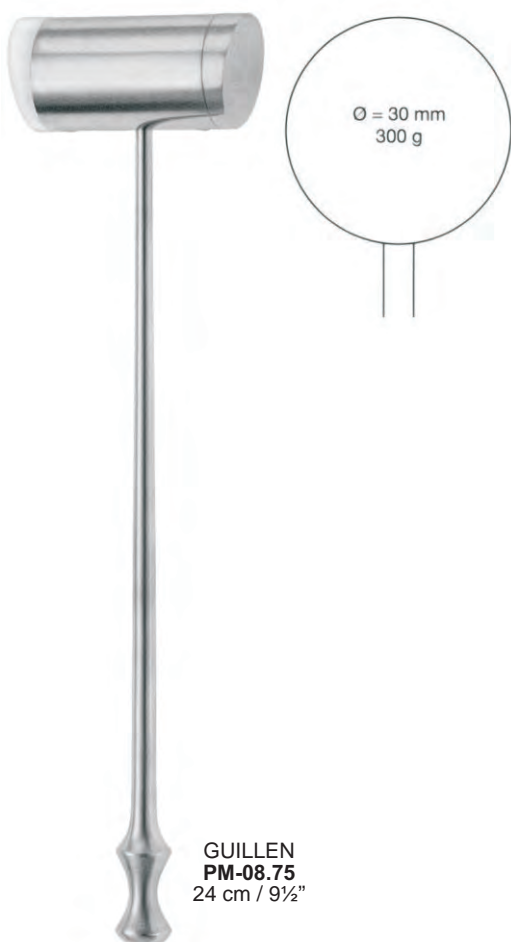

**GUILLEN**  
**PM-08.75**  
 24 cm / 9½"

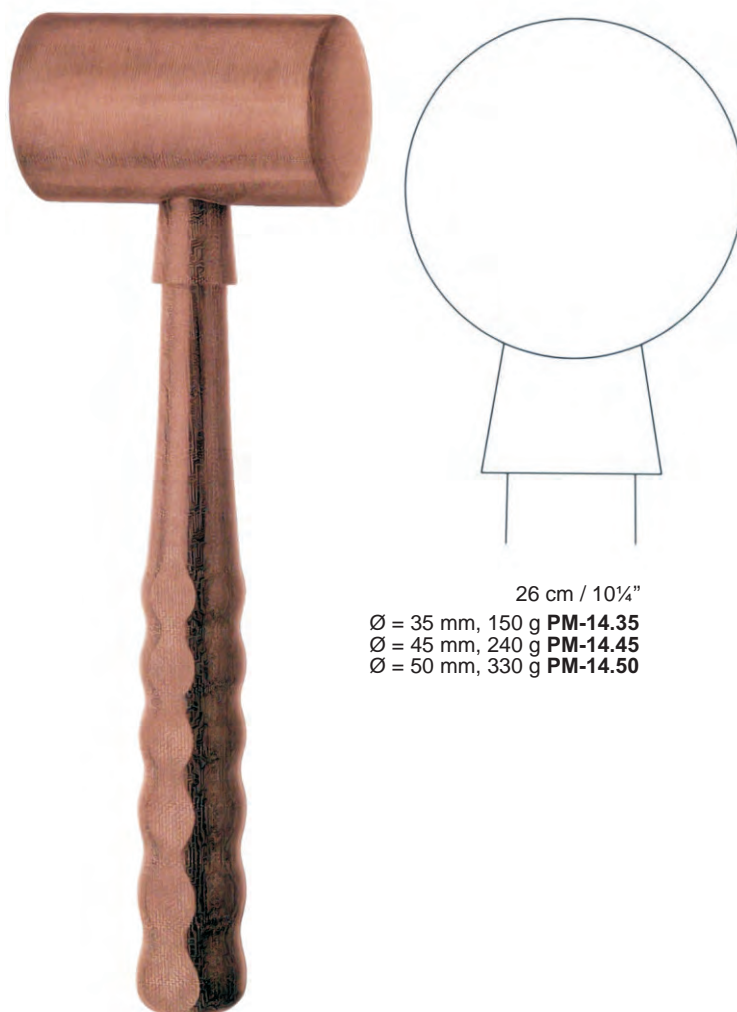

26 cm / 10¼"  
 Ø = 35 mm, 150 g **PM-14.35**  
 Ø = 45 mm, 240 g **PM-14.45**  
 Ø = 50 mm, 330 g **PM-14.50**

**Elevators**  
 Elevadores  
 Elévateurs  
 Elevatori



**NAGATA**  
**PT-11.26**  
 16 cm / 6¼"



**NAGATA**  
**PT-11.27**  
 17 cm / 6¾"



**LANGENBECK**  
**PT-13.04**  
 23 cm / 9"



**WILLIGER**  
 16 cm / 6¼"

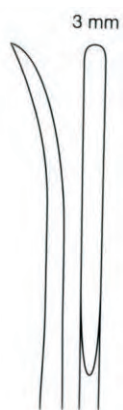

**PT-15.03**

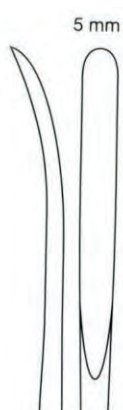

**PT-15.05**



**PT-15.07**



**MCKENTY**  
 15 cm / 6"



**PT-17.04**

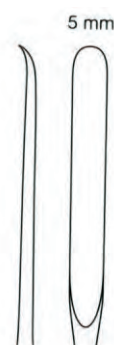

**PT-17.05**



**FREER**  
**PT-18.01**  
 19 cm / 7½"

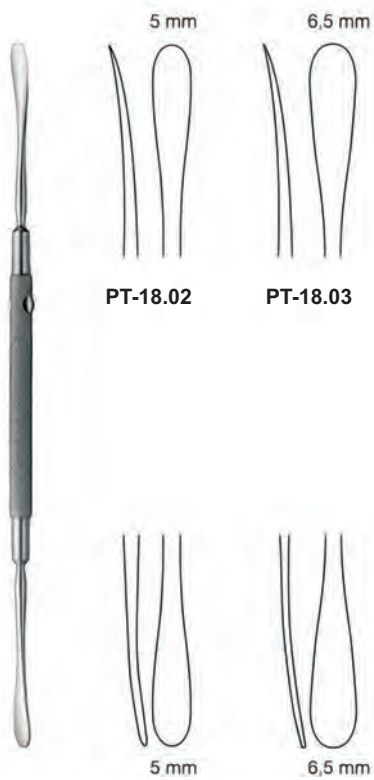

**FREER**  
19 cm / 7½"



**COHEN**  
**PT-18.24**  
24 cm / 9½"

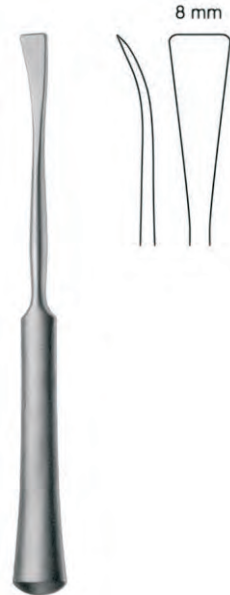

**WALTER**  
**PT-18.38**  
14.5 cm / 5¾"

**Raspatories**  
Legras  
Rugines  
Periostotomi



**WILLIGER WALTER**  
**PAC-243.14**  
14 cm / 5½"

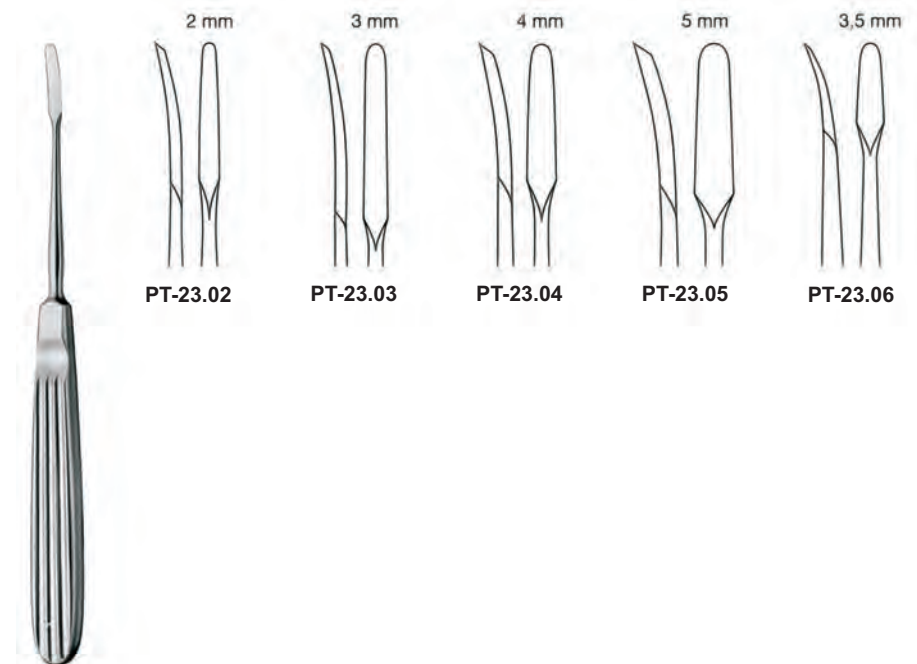

**LEMPERT**  
17 cm / 6¾"



## Lip and Cleft Palate Instruments

Instrumentos para labios y Fisuras paladares

Instruments pour lèvres et fissures palatines

Strumenti per labbra e fessure del palato

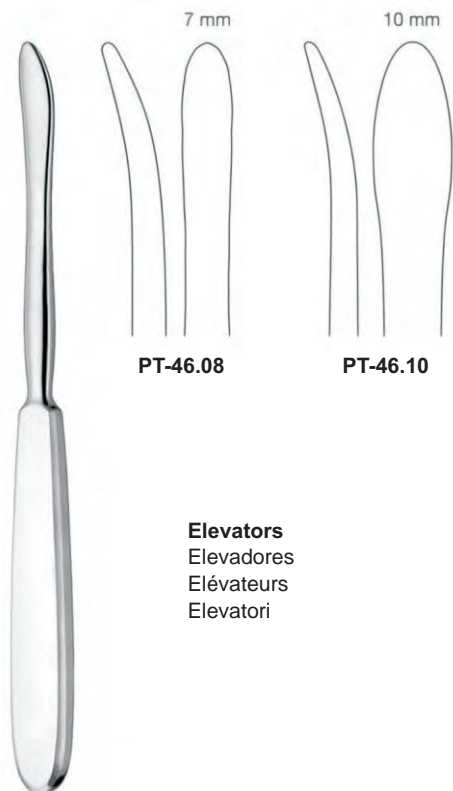
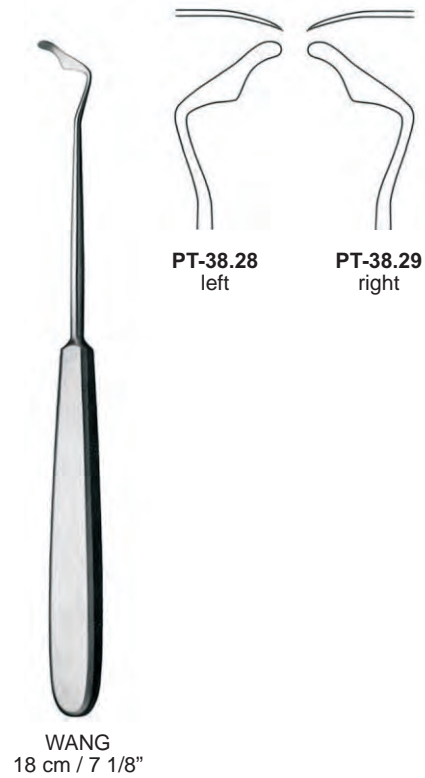
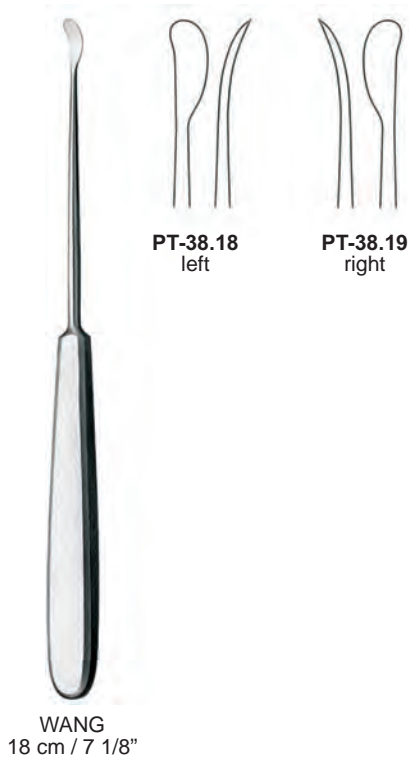

LANGENBECK  
20 cm / 8"

**Wires and Wire Instruments**  
 Alambre y Instrumentos para alambre  
 Fils et instruments pour fils métalliques  
 Fili e strumenti per fili d'acciaio

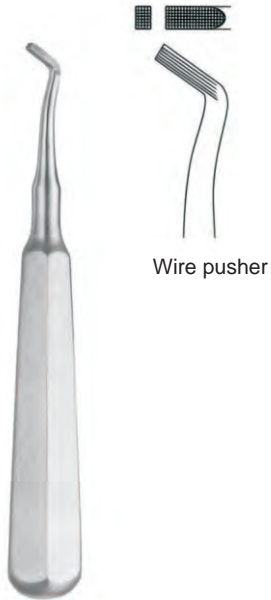

Wire pusher

**MERSHON**  
**PU-04.50**  
 14.5 cm / 5 3/4"



**NIRO**  
**PU-04.65**  
 15 cm / 6"



**OBWEGESER**  
**PU-04.76**  
 15.5 cm / 6 1/8"



**OBWEGESER**  
**PU-48.43**  
 13 cm / 5 1/8"



**AIACH**  
**PU-50.56**  
 16 cm / 6 1/4"



**PU-74.20**

Thickness of wire =  $\varnothing$  0.5 mm

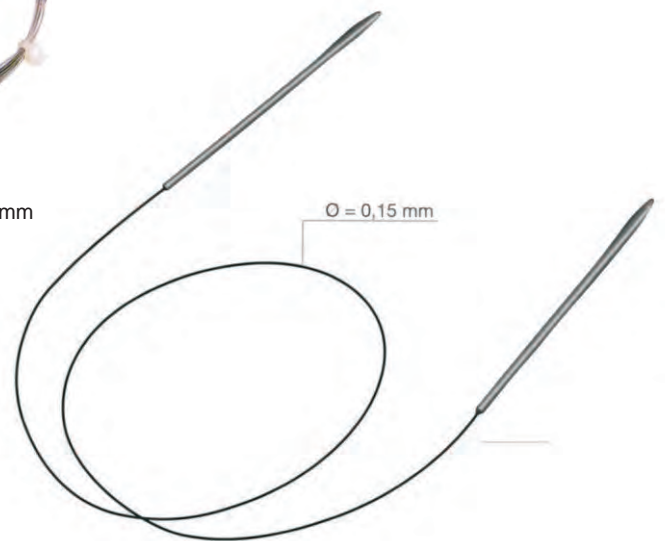

**PU-75.40**  
 20 cm / 8"

**Retactors**  
Separadores  
Ecarteurs  
Divaricatori

---



**Delicate Retractors, double-ended**  
 Separadores fios, dobles  
 Écarteurs fins, doubles  
 Divaricatori delicati, doppi

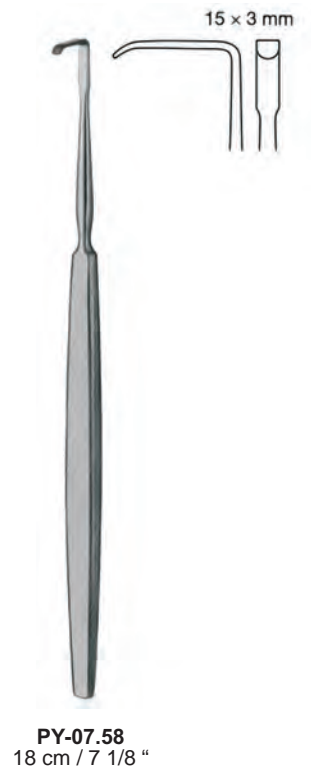
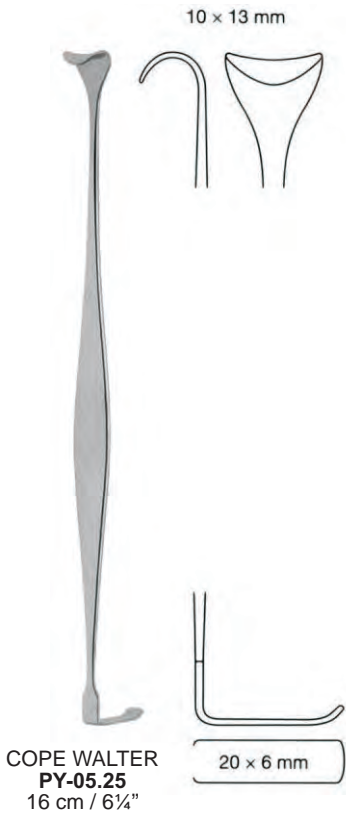
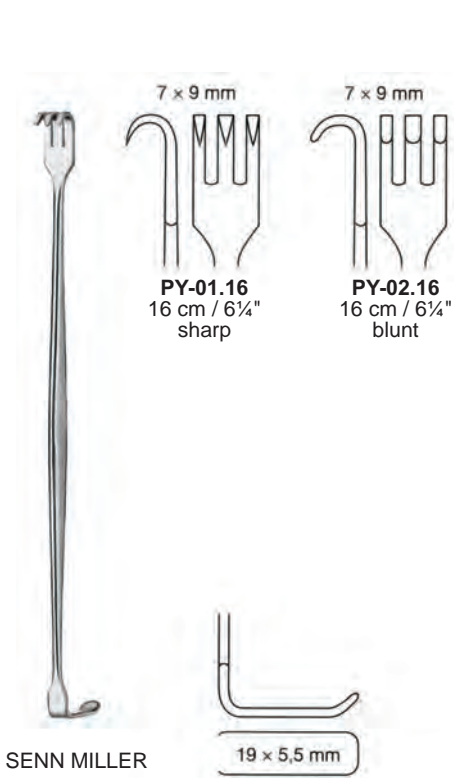

**Delicate Retractors**

Separadores fijos

Ecarteurs fins

Divaricatori delicati

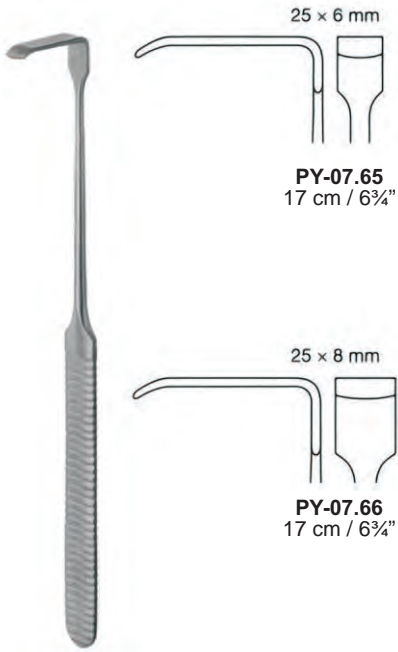

**PY-07.65**  
17 cm / 6¾"

**PY-07.66**  
17 cm / 6¾"

LANGENBECK GREEN



**PY-07.75**  
17 cm / 6¾"

**PY-07.85**  
17 cm / 6¾"

STRANDELL STILLE

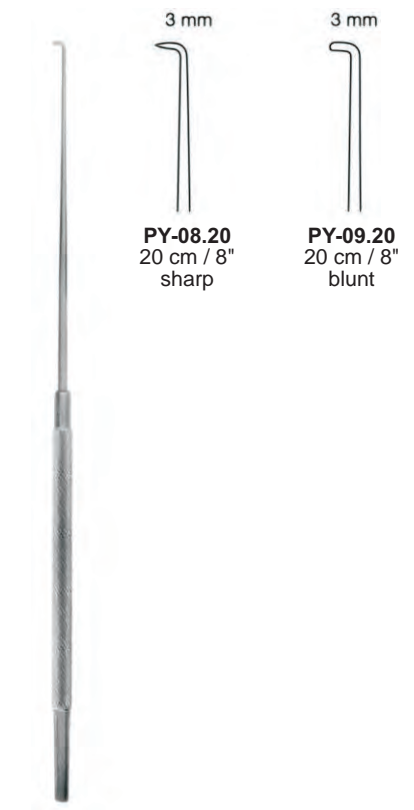

**PY-08.20**  
20 cm / 8"  
sharp

**PY-09.20**  
20 cm / 8"  
blunt

ADSON



**CRILE**  
**PY-10.20**  
20 cm / 8"



**FRAZIER**  
**PY-11.12**  
12.5 cm / 5"



**PY-12.19**  
19 cm / 7½"

**PY-12.20**  
19 cm / 7½"

GILLIES



**STRAIGHT**  
**PY-20.13**  
 13 cm / 5 1/8"



**JOSEPH**



**PY-21.02**  
 17 cm / 6 3/4"



**PY-21.05**  
 17 cm / 6 3/4"

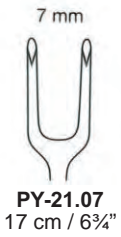

**PY-21.07**  
 17 cm / 6 3/4"



**PY-21.10**  
 17 cm / 6 3/4"



**KLEINERT KUTZ**



**PY-23.03**  
 13 cm / 5 1/8"



**PY-23.05**  
 13 cm / 5 1/8"



**PY-23.07**  
 13 cm / 5 1/8"



**BARSKY**  
**PY-23.15**  
 15 cm / 6"



**BARSKY**  
**PY-23.16**  
 15 cm / 6"



**JACKSON**  
**PY-24.14**  
 14.5 cm / 5 3/8"



**NEWS**  
**PY-24.15**  
 15 cm / 6"

**Delicate Retractors**

Separadores fios

Ecarteurs fins

Divaricatori delicati



**JOSEPH  
PY-24.16**  
16 cm / 6¼"



**HUMBY  
PY-24.21**  
11.5 cm / 4½"



**BERGMANN  
PY-24.24**  
14 cm / 5½"



**PY-24.26**  
16.5 cm / 6½"



**COTTLE  
PY-24.36**  
16 cm / 6¼"



**EMMET  
PY-24.42**  
22 cm / 8¾"



**BENICKE**



**PY-24.50**  
19 cm / 7½"  
sharp



**PY-24.51**  
19 cm / 7½"  
blunt



**GUTHRIE**

1,5 x 2 mm  
**PY-25.13**  
13 cm / 5 1/8"

2 x 3 mm  
**PY-25.23**  
13 cm / 5 1/8"



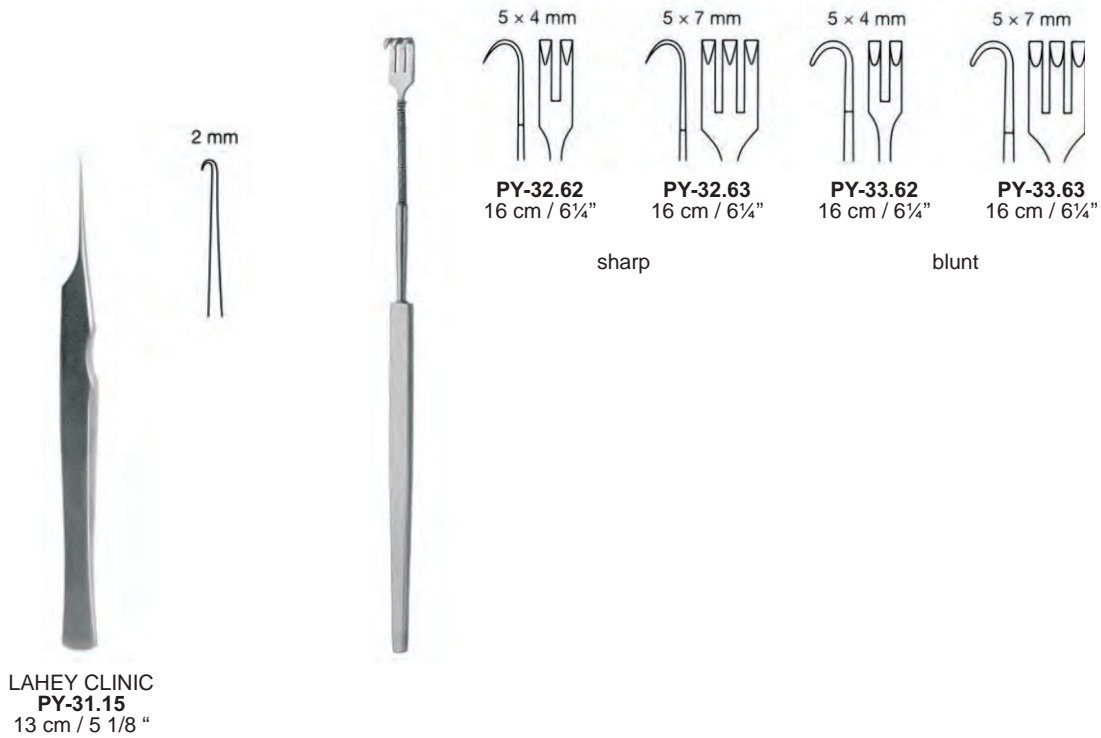
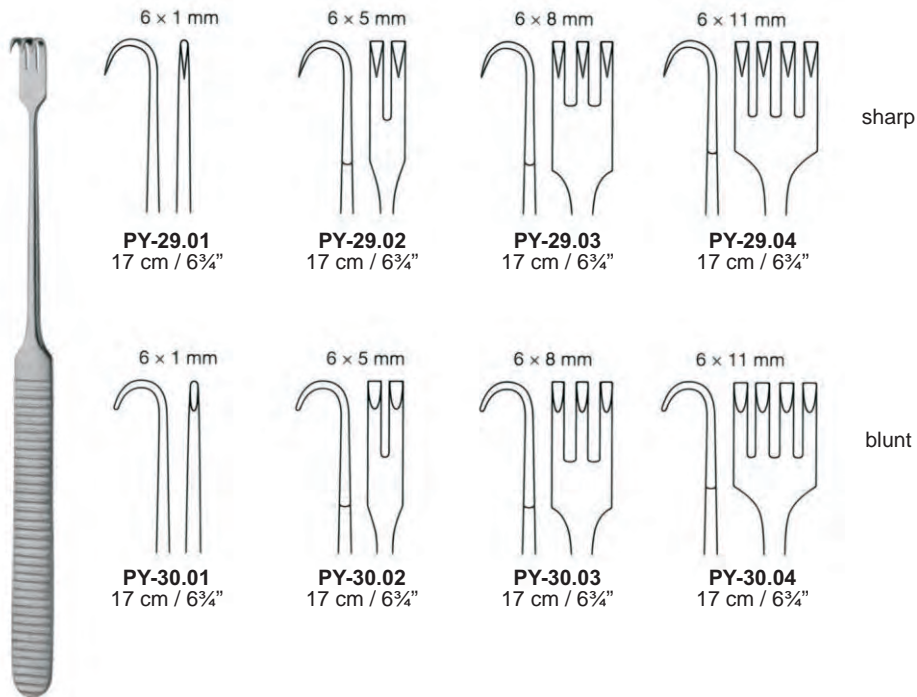

**Delicate Retractors**  
 Separadores fios  
 Ecarteurs fins  
 Divaricatori delicati

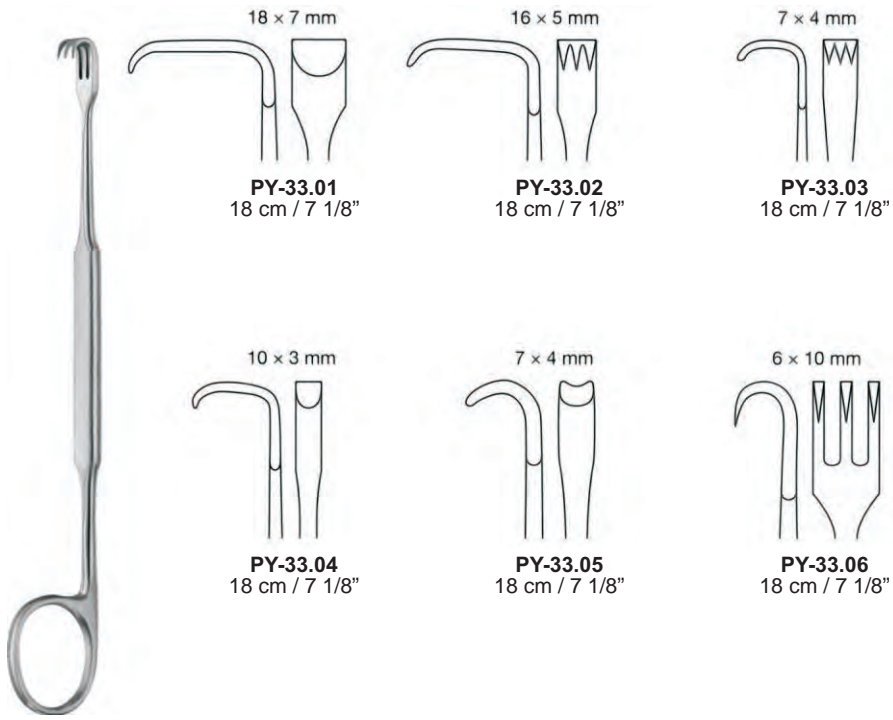

MEYERDING

18 x 7 mm

**PY-33.01**  
18 cm / 7 1/8"

16 x 5 mm

**PY-33.02**  
18 cm / 7 1/8"

7 x 4 mm

**PY-33.03**  
18 cm / 7 1/8"

10 x 3 mm

**PY-33.04**  
18 cm / 7 1/8"

7 x 4 mm

**PY-33.05**  
18 cm / 7 1/8"

6 x 10 mm

**PY-33.06**  
18 cm / 7 1/8"



FARABEUF BABY  
**PY-46.12**  
12 cm / 4 3/4"



FARABEUF  
**PY-47.15**  
15 cm / 6"

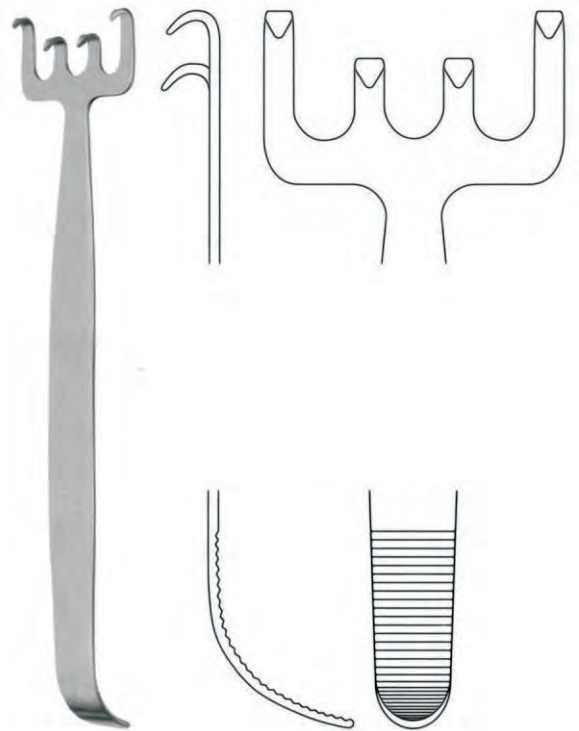

WALTER  
**PY-51.39**  
19 cm / 7 1/2"

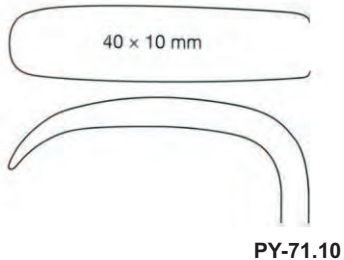
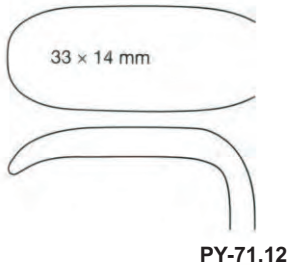
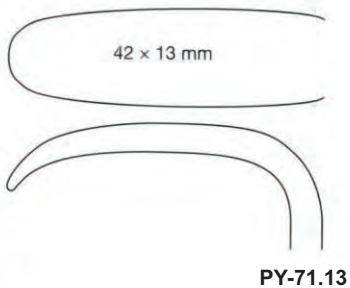
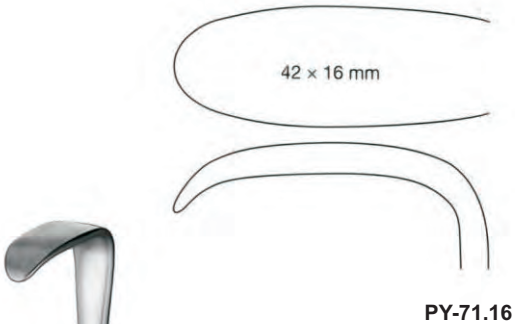

KOCHER  
 21 cm / 8¼"

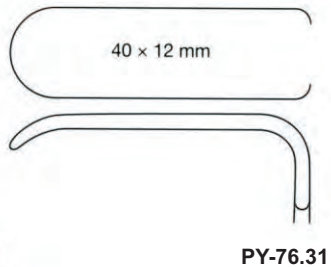
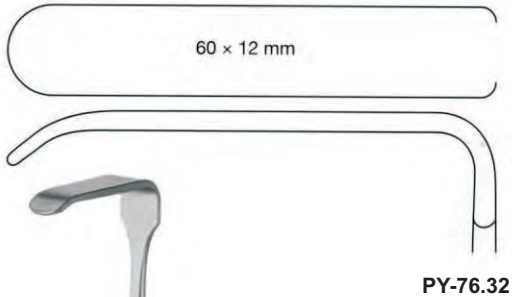

KOCHER  
 22 cm / 8¾"

## Areola Marker and Breast Elevator

marcadores para aréola y elevador mamario  
maqueurs pour l'aréole et élévateur mammaire  
marcatori per areola e elevators mamario

Breast elevator



**PY-90.00**  
28 cm / 11"



SOLZ  
Ø = 36 mm **PY-90.20**  
Ø = 40 mm **PY-90.25**  
Ø = 42 mm **PY-90.30**  
Ø = 42 mm **PY-90.35**



**PAF-06.06**  
Ø = 6 cm (0.06l)

Atraumatic breast dissector  
Disector mamario atrumático  
Dissecteur mammaire atraumatique  
Dissettoire mammario atraumatico



SOLZ  
**PY-90.10**  
34 cm / 13 3/8"

**PY-90.11**  
37 cm / 14 1/2"



Hook dissector  
Disector de gancho  
Crochet Dissecteur  
Dissettoire a uncino

SOLZ  
**PY-90.15**  
36 cm / 14 1/8"

**Breast Retractors**  
Separadores mamarios  
Ecarteurs mammaires  
Divaricatori mammari

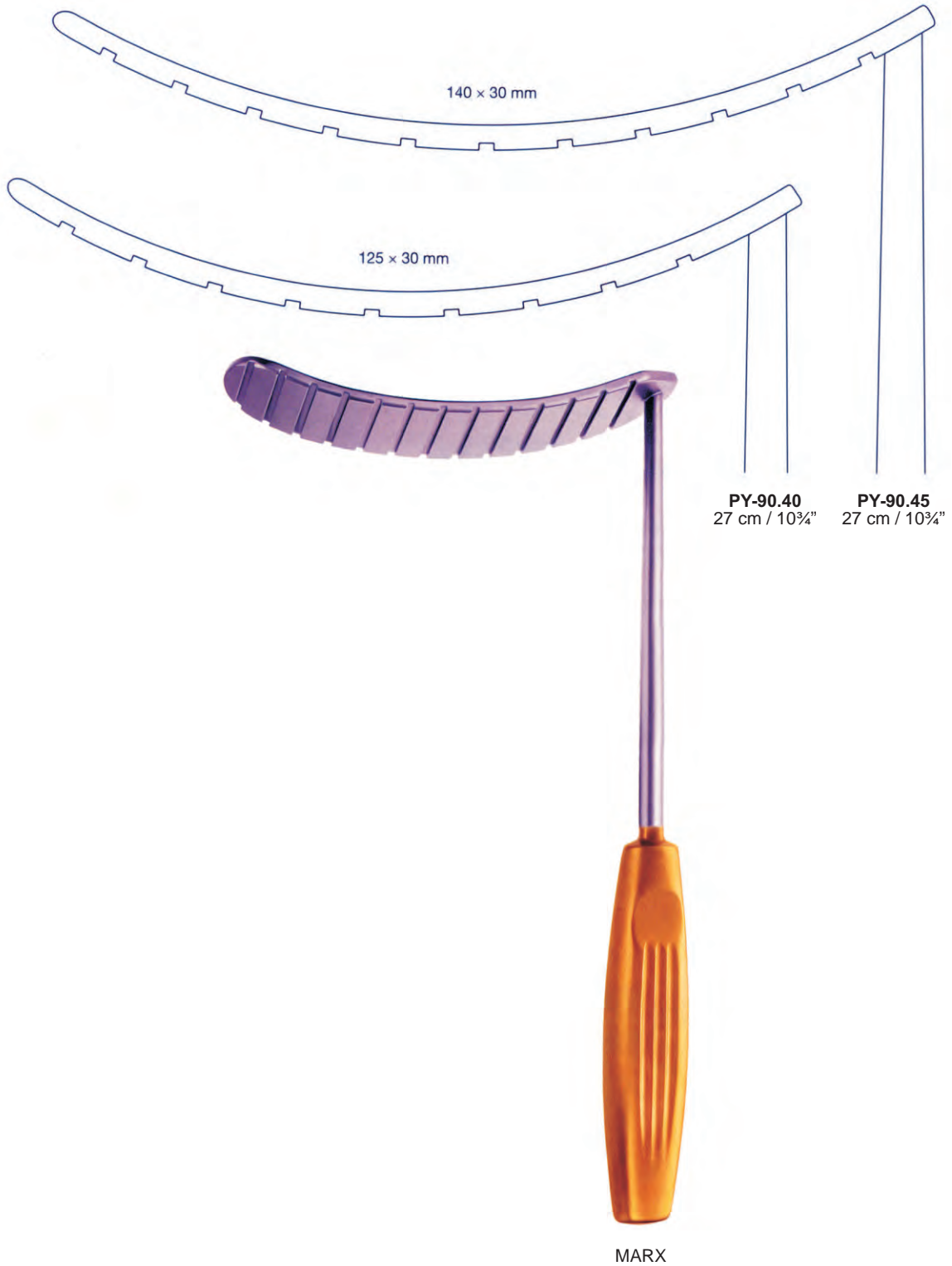

**Abdominal Retractor for Lipoabdominoplasty**  
Separador abdominal para la lipoabdominaoplastia  
Ecarteur abdominal pour la plastie lipo-abdominale  
Divaricatore addominale per la lipoaddominoplastica

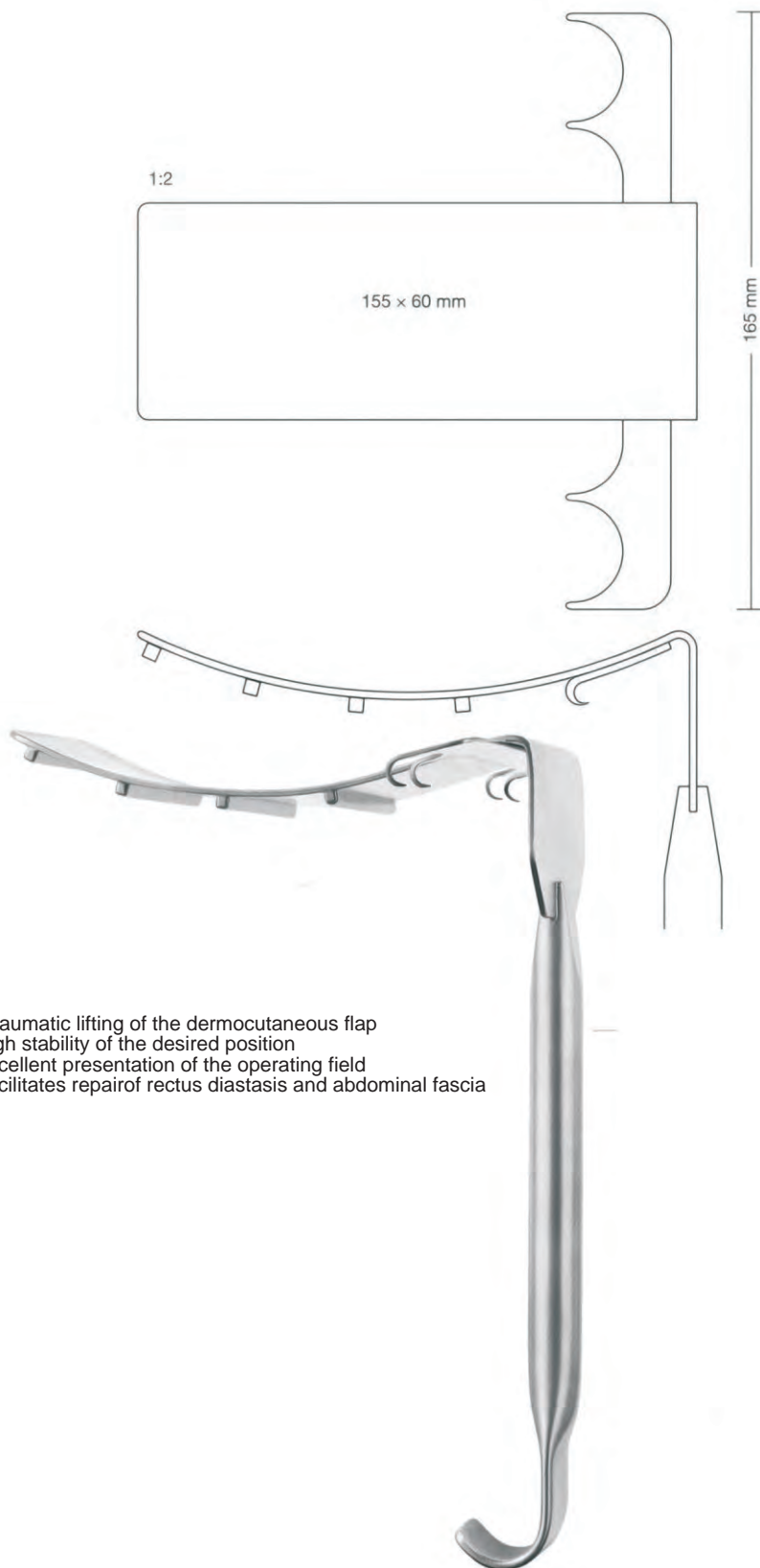

Atraumatic lifting of the dermocutaneous flap  
High stability of the desired position  
Excellent presentation of the operating field  
Facilitates repair of rectus diastasis and abdominal fascia

**SALDANHA SOLZ**  
**PY-90.50**  
23.5 cm / 9 1/4"



**Navel Marker**

Posicionador de ombligo  
Positionneur du nombril  
Posizionatore dell'ombelico

Exact re-positioning of the navel in correspondence  
High stability of the desired position  
Excellent presentation of the operating field  
Facilitates repair of rectus diastasis and abdominal fascia

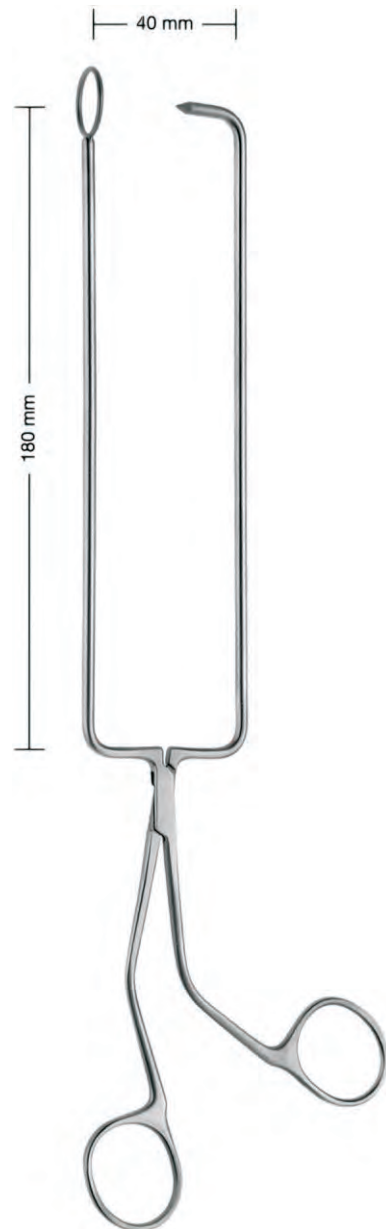

SOLZ  
PY-90.53  
29 cm / 11 3/8"

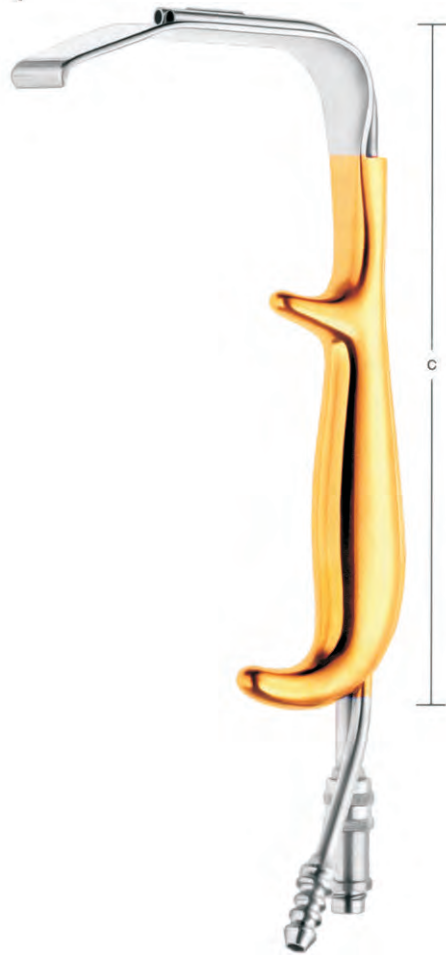

	a [mm]	b [mm]
<b>PY-100.01</b>	90	24
<b>PY-100.02</b>	90	30
<b>PY-100.03</b>	115	24
<b>PY-100.04</b>	150	36
<b>PY-100.05</b>	190	30

with fiber optic illumination and irrigation tube  
 con iluminación de luz fría y tubo lavador  
 avec illumination à lumière froide et tuyeau de lavage  
 con illuminazione a luce fredda e tubo di lavaggio

**TEBBETTS**  
 c = 18.5 cm / 7¼"

**Self-retaining Retractors**  
 Separadores autoestáticos  
 Ecarteurs autostatiques  
 Divaricatori autostatici

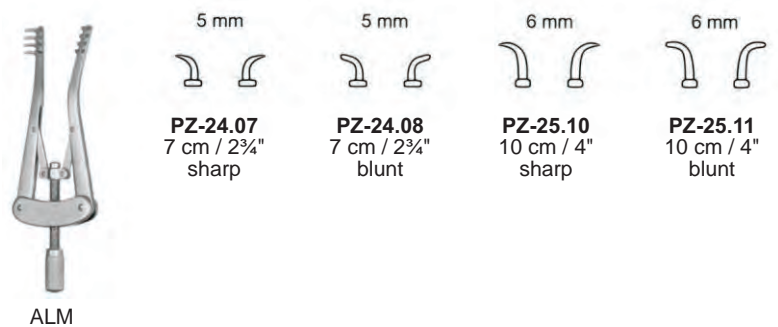
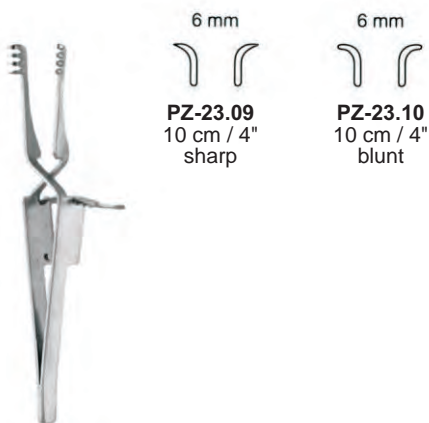
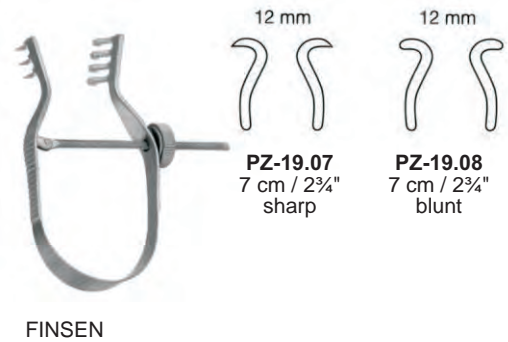
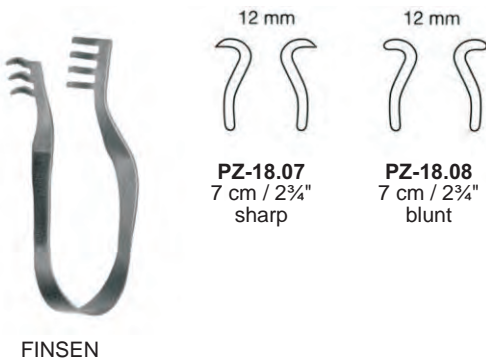
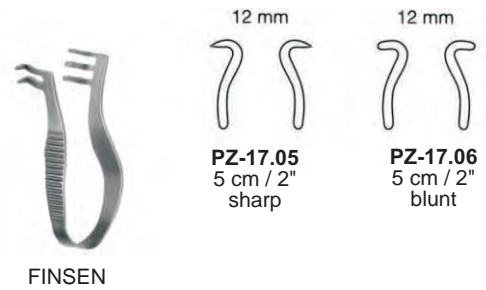
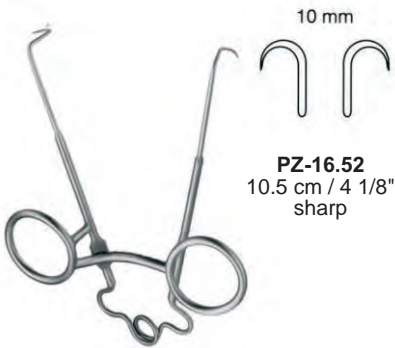
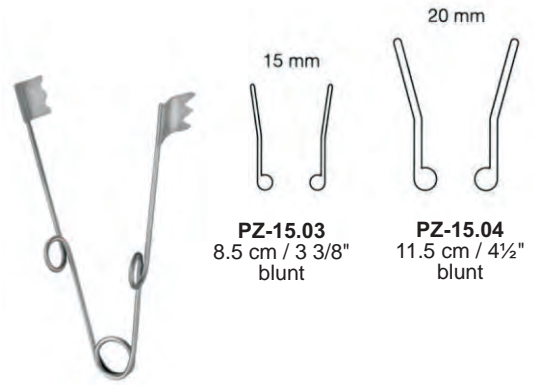
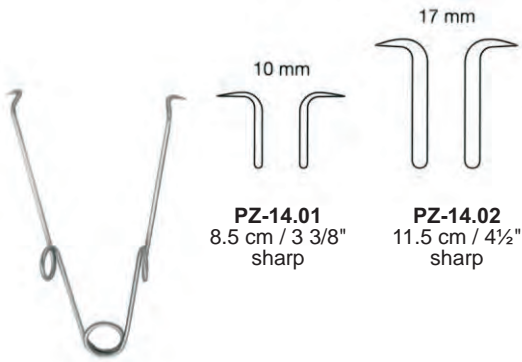



**WEITLANER**  
**PZ-26.13**  
 13 cm / 5 1/8"

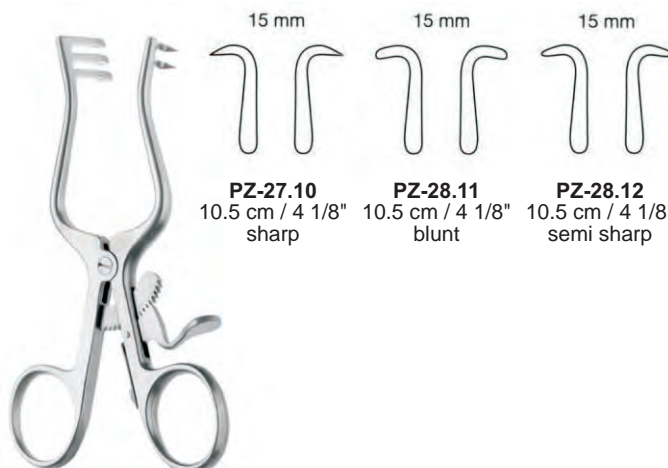

**PZ-27.10**  
 10.5 cm / 4 1/8"  
 sharp

**PZ-28.11**  
 10.5 cm / 4 1/8"  
 blunt

**PZ-28.12**  
 10.5 cm / 4 1/8"  
 semi sharp

**WEITLANER**

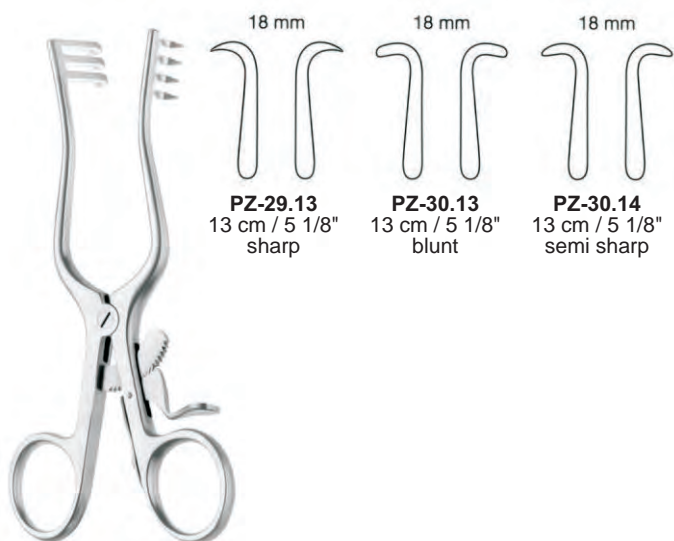

**PZ-29.13**  
 13 cm / 5 1/8"  
 sharp

**PZ-30.13**  
 13 cm / 5 1/8"  
 blunt

**PZ-30.14**  
 13 cm / 5 1/8"  
 semi sharp

**WEITLANER**

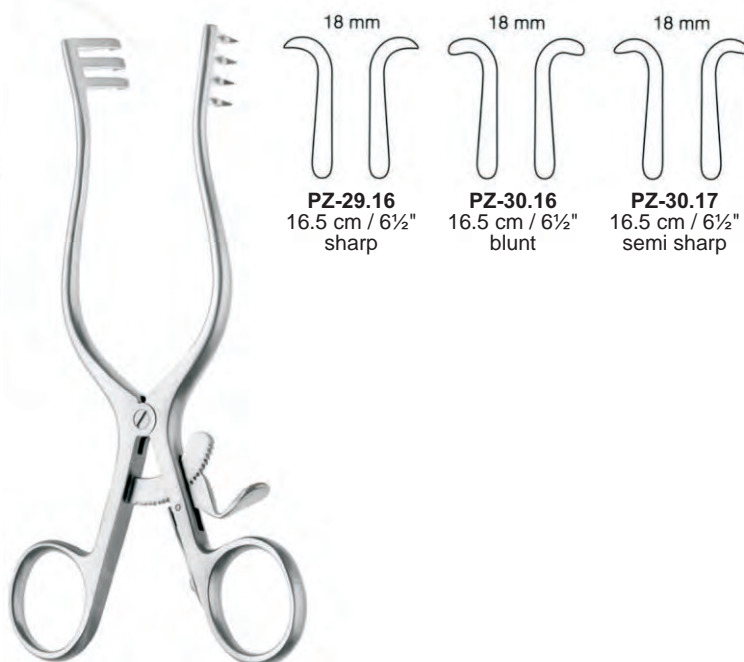

**PZ-29.16**  
 16.5 cm / 6 1/2"  
 sharp

**PZ-30.16**  
 16.5 cm / 6 1/2"  
 blunt

**PZ-30.17**  
 16.5 cm / 6 1/2"  
 semi sharp

**WEITLANER**

**Retractor**  
 Separadores  
 Ecarteurs  
 Divaricatori

8 × 10 mm

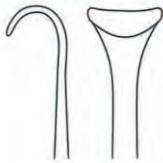

**PAB-164.00**  
 14 cm / 5½"  
 #0

9 × 12 mm

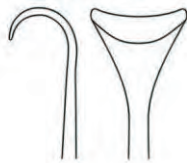

**PAB-164.01**  
 14 cm / 5½"  
 #1

10 × 14 mm

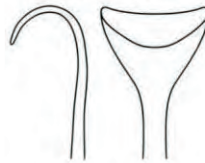

**PAB-164.02**  
 14 cm / 5½"  
 #2

10 × 16 mm

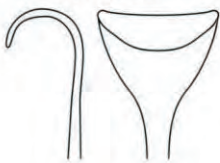

**PAB-164.03**  
 14 cm / 5½"  
 #3

12 × 18 mm

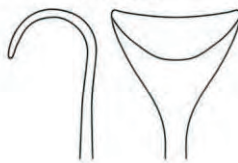

**PAB-164.04**  
 14 cm / 5½"  
 #4



DESMARRES

Mandibular rim retractor  
 Separador para el borde del maxilar inferior  
 Ecarteur pour le bord du maxillaire inférieur  
 Divaricatore per il bordo della mascella inferiore

45 × 9/12 mm

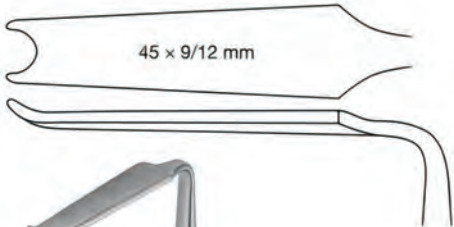

**PAS-09.17**  
 17 cm / 6¾"



**PAS-09.26**  
 22 cm / 8¾"



70 × 11/15 mm

**PAS-09.26**

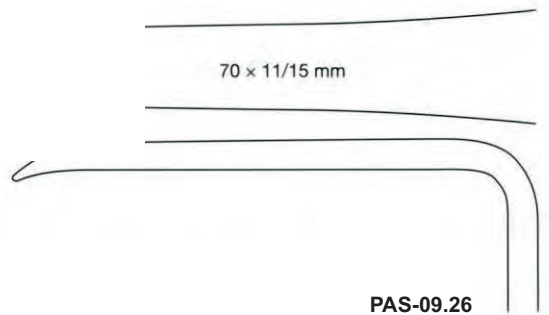

70 × 12/22 mm

**PAS-09.27**

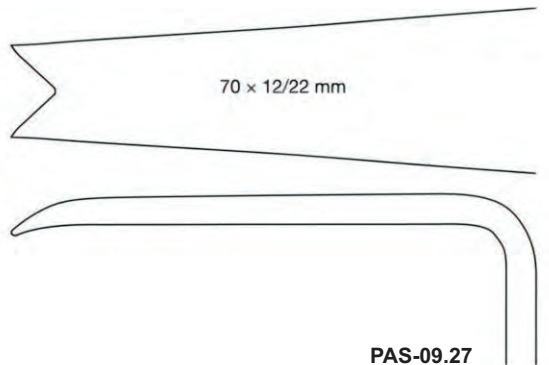

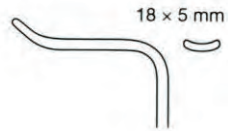

**PAS-09.31**

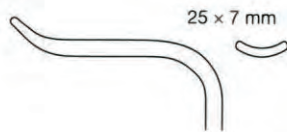

**PAS-09.32**

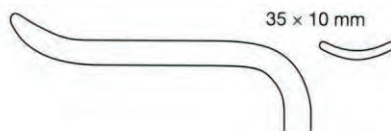

**PAS-09.33**



**PAS-09.34**



**PAS-09.35**



**PAS-09.36**



**PAS-09.37**



**OBWEGESER**  
23 cm / 9"

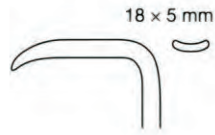

**PAS-09.41**

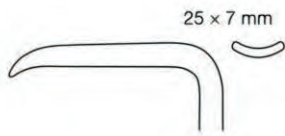

**PAS-09.42**

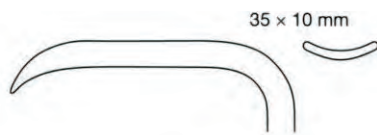

**PAS-09.43**

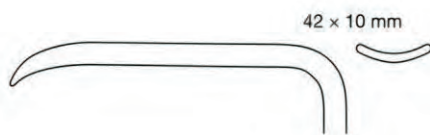

**PAS-09.44**



**PAS-09.45**

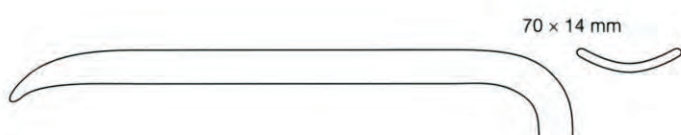

**PAS-09.46**



**PAS-09.47**



**OBWEGESER**  
22.5 cm / 9"



Wisdom tooth retractor  
Separador para muela del juicio  
Ecarteur pour dent de sagesse  
Divaricatore per dente del giudizio



**OBWEGESER**  
**PAS-09.63**  
22.5 cm / 9"

Nasal spine retractor  
Separador para espina nasal  
Ecarteur d'épine nasale  
Separatore per spina nasale



**OBWEGESER**  
**PAS-09.65**  
22.5 cm / 9"



OBWEGESER

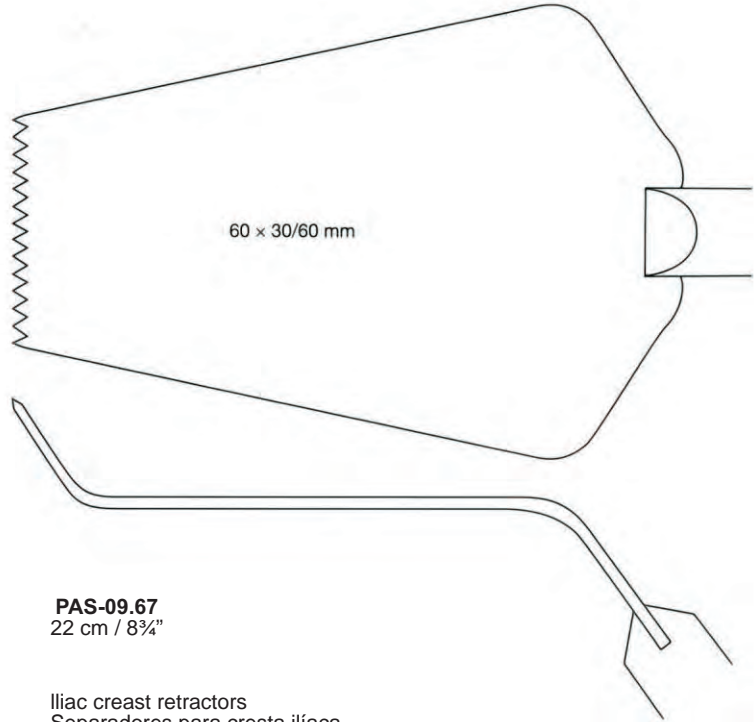

**PAS-09.67**  
22 cm / 8 $\frac{3}{4}$ "

Iliac crest retractors  
Separadores para cresta iliaca  
Ecarteurs iliaques  
Divaricatori per cresta iliaca

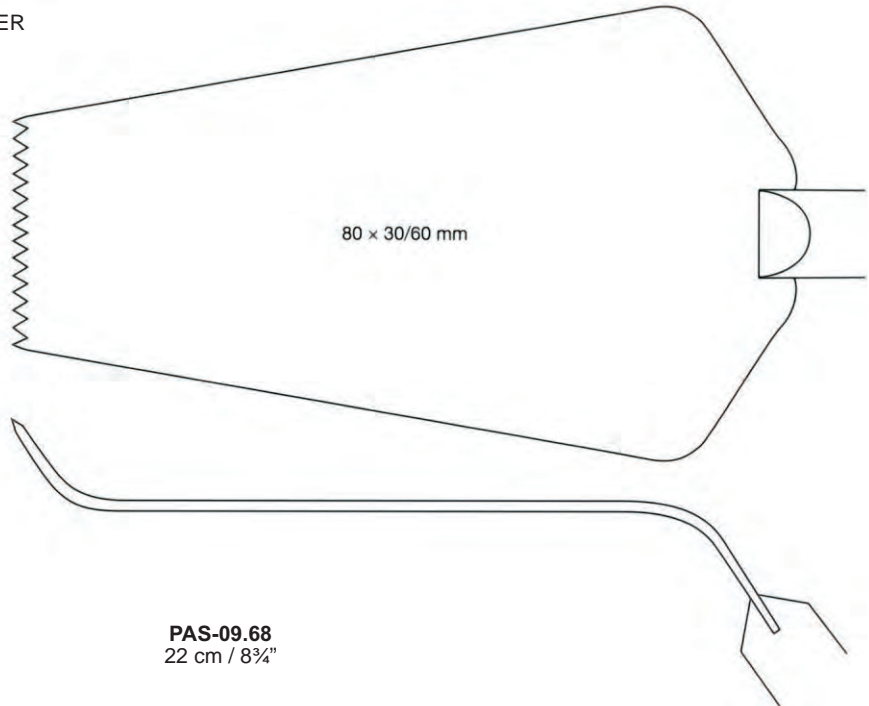

**PAS-09.68**  
22 cm / 8 $\frac{3}{4}$ "



OBWEGESER

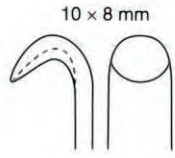

**PAS-10.26**  
 17.5 cm / 7"

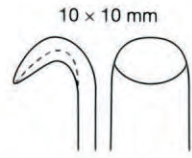

**PAS-10.27**  
 17.5 cm / 7"

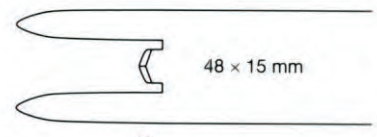

OBWEGESER  
**PAS-10.28**  
 16 cm / 6¼"



DOYEN  
 17 cm / 6¾"

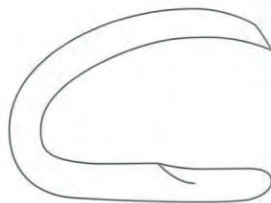

**PAG-46.11**  
 right

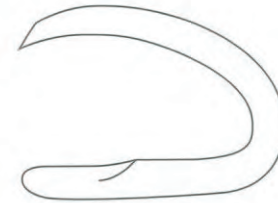

**PAG-46.12**  
 left

**Instruments for Auricular Plastic**  
 Instrumentos para la otoplastia  
 Instruments pour l'otoplastie  
 Strumenti per l'otoplastica

**Nasal Dressing Forceps**

Pinzas nasales para tamponiamento

Pinces à pansements pour le nez

Pinze per tamponamento nasale



HARTMANN  
**PAM-04.16**  
18 cm / 7 1/8"



HARTMANN  
**PAM-05.20**  
20 cm / 8"

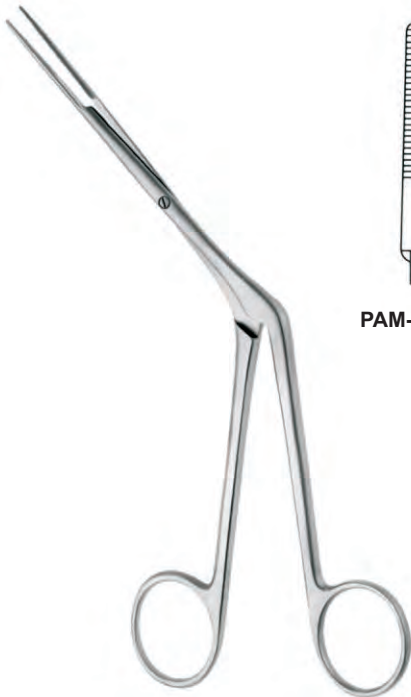

WESTMACOTT  
20 cm / 8"



**PAM-06.20**



**PAM-06.21**



LUBET BARBON  
**PAM-06.30**  
20 cm / 8"



HARTMANN



**PAM-08.15**  
15 cm / 6"

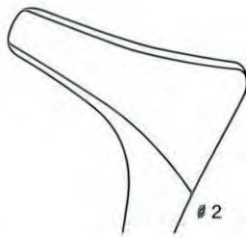

**PAM-08.16**  
15 cm / 6"

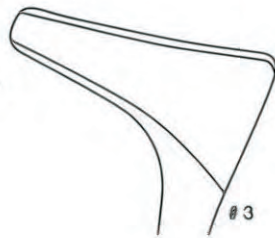

**PAM-08.17**  
15 cm / 6"



TIECK HALLE



**PAM-09.10**  
13.5 cm / 5 3/4"



**PAM-09.11**  
13.5 cm / 5 3/4"



COTTLE

14 cm / 5 1/2"  
 a = 35 mm, #1 **PAM-11.50**  
 a = 55 mm, #2 **PAM-11.51**  
 a = 75 mm, #3 **PAM-11.52**  
 a = 90 mm, #4 **PAM-11.53**



**COTTLE**  
**PAM-11.60**  
 14 cm / 5 1/2"

**Nasal Specula**  
 Espéculos nasales  
 Spéculums nasaux  
 Specoli nasali



**COTTLE**  
**PAM-11.62**  
 13 cm / 5 1/8"



"MOD. WIEN"

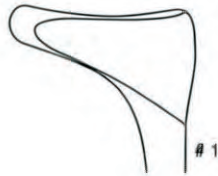

**PAM-16.15**  
 14 cm / 5 1/2"



**PAM-16.16**  
 14 cm / 5 1/2"



**PAM-16.17**  
 14 cm / 5 1/2"



14 cm / 5 1/2"  
 a = 35 mm, #1 **PAM-14.14**  
 a = 50 mm, #2 **PAM-14.15**  
 a = 75 mm, #3 **PAM-14.16**  
 a = 90 mm, #4 **PAM-14.17**



KILLIAN



**KILLIAN**  
**PAM-14.59**  
 14 cm / 5 1/2"



**COTTLE**  
**PAN-67.11**  
 11 cm / 4 3/8"



**Mucosa knife**

Cuchillo para mucosa  
Septotome  
Cotello per mucosa



**FREER**  
**PAM-20.16**  
16 cm / 6 1/4"



**BALLENGER**  
16 cm / 6 1/4"

4 mm



**PAM-24.16**

6 mm



**PAM-24.17**



**FREER**  
15.5 cm / 6 1/8"

4 mm



**PAM-25.16**

6 mm



**PAM-25.17**



**KILLIAN**  
**PAM-25.46**  
17.5 cm / 7"

6 mm



**KILLIAN CLAUS**  
**PAM-25.47**  
17 cm / 6 3/4"

6 mm



**PAM-30.50**  
20 cm / 8"





**Nasal Septum Forceps**

Pinzas para el tabique nasal  
Pinces pour la cloison nasale  
Pinze per il setto nasale



PAM-34.11



PAM-34.12

LUC BRUNINGS  
(HEYMANN)  
18 cm / 7 1/8"



CRAIG  
PAM-34.15  
17 cm / 6 3/4"



PAM-34.16



PAM-34.17

CRAIG DOMNICK  
17 cm / 6 3/4"



HEYMANN  
PAM-34.75  
18 cm / 7 1/8"



		straight	angled upwards	angled upwards
			45°	90°
	3,0 mm	PAM-44.01	PAM-44.11	PAM-45.11
	3,6 mm	PAM-44.02	PAM-44.12	PAM-45.12
with normal shaft	4,2 mm	PAM-44.03	PAM-44.13	PAM-45.13
	4,8 mm	PAM-44.04	PAM-44.14	PAM-45.14
	5,6 mm	PAM-44.05	PAM-44.15	PAM-45.15
	3,0 mm	PAM-44.71	PAM-44.81	
	3,6 mm	PAM-44.72	PAM-44.82	
with slim shaft	4,2 mm	PAM-44.73	PAM-44.83	
	4,8 mm	PAM-44.74	PAM-44.84	
	5,6 mm	PAM-44.75	PAM-44.85	

**Nasal Forceps**

Pinzas nasal  
Pinces nasale  
Pinze nasali

11,5 cm - 4½"



WEIL BLAKESLEY

2,0 mm 

**PAM-44.26**

2,5 mm 

**PAM-44.27**

3,0 mm 

**PAM-44.28**

straight



angled upwards

**45°**



**PAM-44.35**

**PAM-44.76**

**PAM-44.37**

11,5 cm - 4½"



BLAKESLEY

straight



**PAM-44.59**

angled upwards



**PAM-44.60**

angled upwards

**90°**



**PAM-44.61**

3,0 mm 

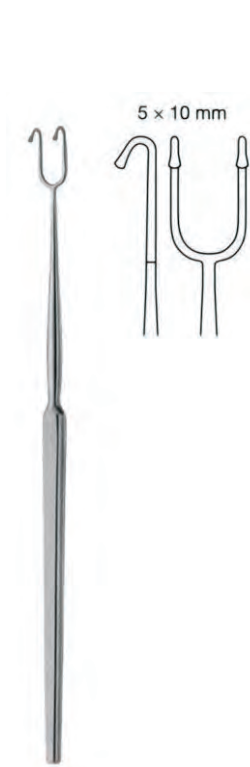

**FOMON**  
**PAN-01.17**  
 17 cm / 6¾"



**NEIVERT**  
**PAN-01.19**  
 19 cm / 7½"

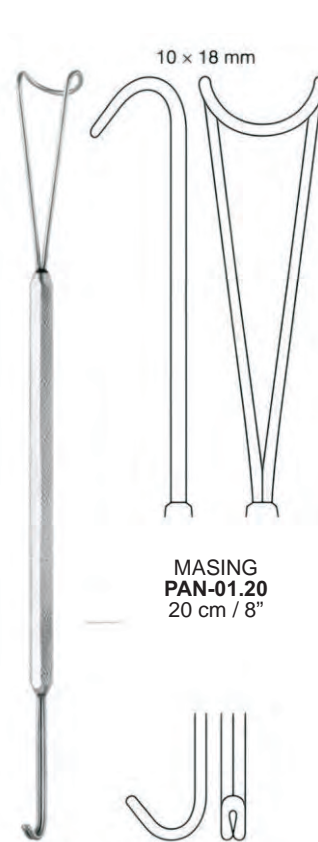

**MASING**  
**PAN-01.20**  
 20 cm / 8"



**COTTLE NEIVERT**  
**PAN-01.21**  
 21 cm / 8¼"



**MILARD (COTTLE)**  
**PAN-01.23**  
 5.5 cm / 2 1/8"



**COTTLE**  
**PAN-01.44**  
 15 cm / 6"



**COTTLE**  
 15 cm / 6"



**PAN-02.14**



**PAN-03.14**



**PAN-04.14**

**Nasal Retractors**  
 Separadores anales  
 Ecarteurs nasaux  
 Divaricatori nasali



**COTTLE**  
**PAN-04.15**  
 15 cm / 6"



**KILNER**  
**PAN-04.10**  
 10 cm / 4"



**COTTLE**  
**PAN-05.14**  
 14 cm / 5½"



**COTTLE**  
**PAN-05.16**  
 15 cm / 6"

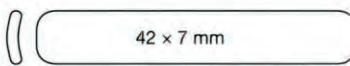

**AUFRICHT WALTER**  
 13.5 cm / 5 3/8"

**PAN-06.14**

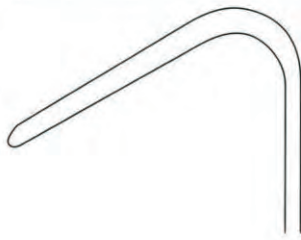
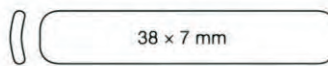

**PAN-06.15**

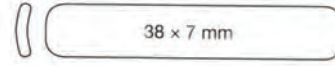
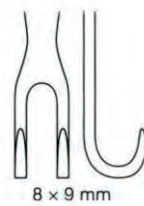

**AUFRICHT**  
**PAN-06.17**  
 13.5 cm / 5 3/8"

13 x 9 mm



**PAN-06.30**  
 18.5 cm / 7 1/4"

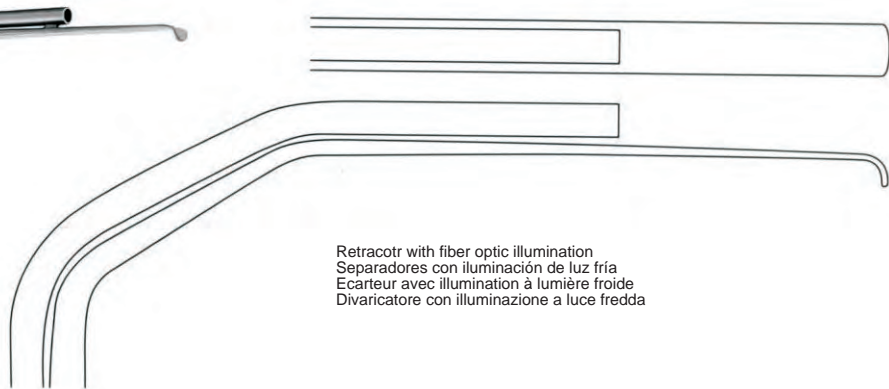

Retractor with fiber optic illumination  
 Separadores con iluminación de luz fría  
 Ecarteur avec illumination à lumière froide  
 Divaricatore con illuminazione a luce fredda



**CONVERSE**  
**PAN-09.12**  
 12 cm / 4 3/4"



**GUBISCH AUFRICHT**  
**PAN-10.17**  
 17 cm / 6 3/4"



**AUFRICHT**  
**PAN-10.19**  
 18 cm / 7 1/8"



**Rhinoplasty Knives**

Cuchillos para rinoplastía  
 Couteaux pour rhinoplastie  
 bisturi per rinoplastica



**COTTLE**  
**PAN-15.14**  
 14 cm / 5½"

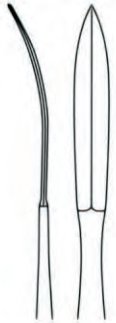

**JOSEPH**  
**PAN-12.15**  
 15 cm / 6"



**COTTLE**  
**PAN-13.14**  
 14 cm / 5½"



**JOSEPH**  
**PAN-13.16**  
 16 cm / 6¼"



**CONVERSE**  
**PAN-14.15**  
 15 cm / 6"



**COTTLE**  
**PAN-15.14**  
 14 cm / 5½"



**JOSEPH**  
**PAN-17.26**  
 12.5 cm / 5"

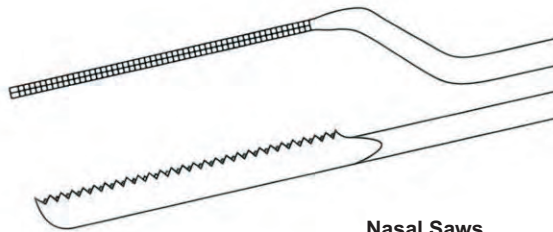
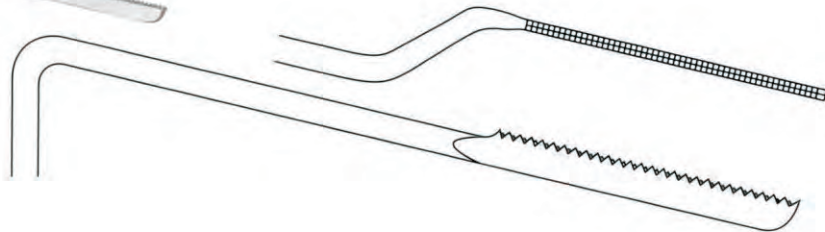

**Nasal Saws**  
 Sierras nasales  
 Scies nasales  
 Seghe nasali



**JOSEPH**  
**PAN-17.27**  
 12.5 cm / 5"



**Nasal Rasps**  
 Raspadores nasales  
 Râpes nasales  
 Raspe nasali



**JOSEPH**  
 17 cm / 6¾"



**PAN-20.24**  
 left



**PAN-18.24**  
 right

**Nasal Saws**  
 Sierras nasales  
 Scies nasales  
 Seghe nasali



**JOSEPH**  
**PAN-19.24**  
 17 cm / 6¾"



**COTTLE**  
**PAN-21.24**  
 21 cm / 8¼"

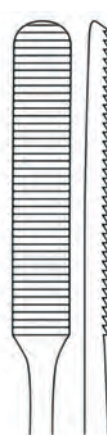

**COTTLE**  
**PAN-21.25**  
 20.5 cm / 8"

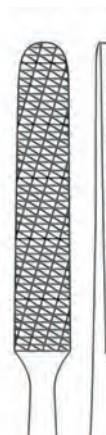

**MALTZ**  
**PAN-22.25**  
 18.5 cm / 7¼"

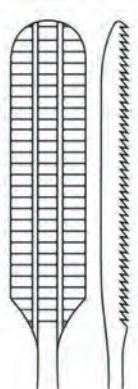

**PAN-23.47**  
 19.5 cm / 7¾"

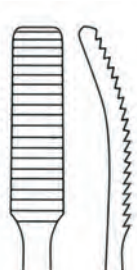

**LEWIS**  
**PAN-23.50**  
 19.5 cm / 7¾"

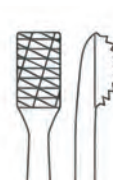

**Nasal Rasps**  
 Raspadores nasales  
 Râpes nasales  
 Raspe nasali



**PAN-24.35**  
 15 cm / 6"  
 left

**PAN-24.36**  
 15 cm / 6"  
 right

CARTILAGE ABRADERS  
**PAN-24.10**  
 Set complete (#1+2)

DINGMAN



LEWIS  
**PAN-24.26**  
 20 cm / 8"

KISTLER



**PAN-24.45**  
 16 cm / 6¼"

**PAN-24.46**  
 16 cm / 6¼"

Anthelix Cartilage File for Auricular Plastic  
 Lima para el cartilago del anthelix para la otoplastia  
 Lime pour le cartilage de l'anthelix pour l'otoplastie  
 Lima per cartilagine del anthelix per l'otoplastica



**PAN-25.00**  
 14 cm / 5½"

**PAN-25.01**  
 14 cm / 5½"



**PAN-25.81**  
 Fig. 1

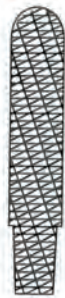

**PAN-25.82**  
 Fig. 2



**PAN-25.83**  
 Fig. 3



**PAN-25.84**  
 Fig. 4



**PAN-25.85**  
 Fig. 5



**PAN-25.86**  
 Fig. 6



**PAN-25.87**  
 Fig. 7



**PAN-25.88**  
 Fig. 8



**PAN-25.89**  
 Fig. 9



**PAN-25.90**  
 Fig. 10



WRENCH  
**PAN-25.03**



AUFRICHT

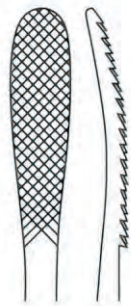

**PAN-25.26**  
21 cm / 8¼"

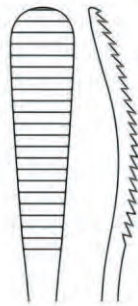

**PAN-25.27**  
21 cm / 8¼"

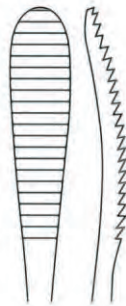

**PAN-25.28**  
21 cm / 8¼"

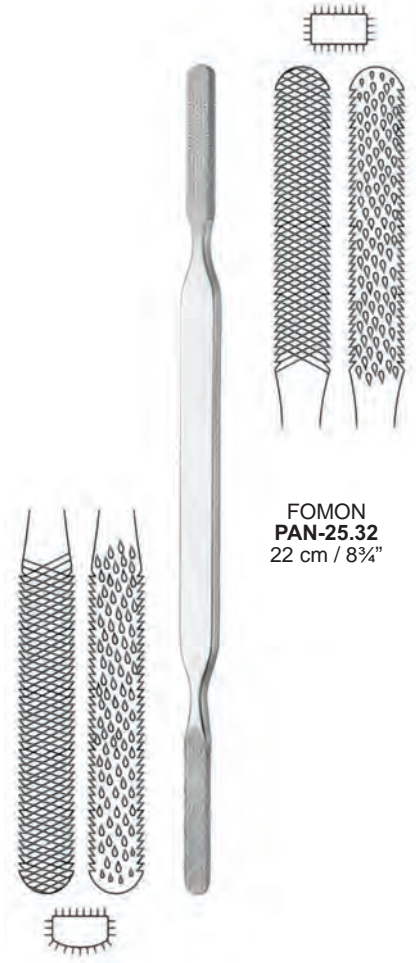

FOMON  
**PAN-25.32**  
22 cm / 8¾"

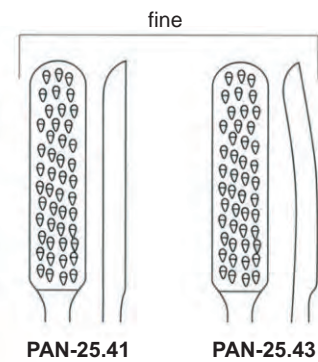
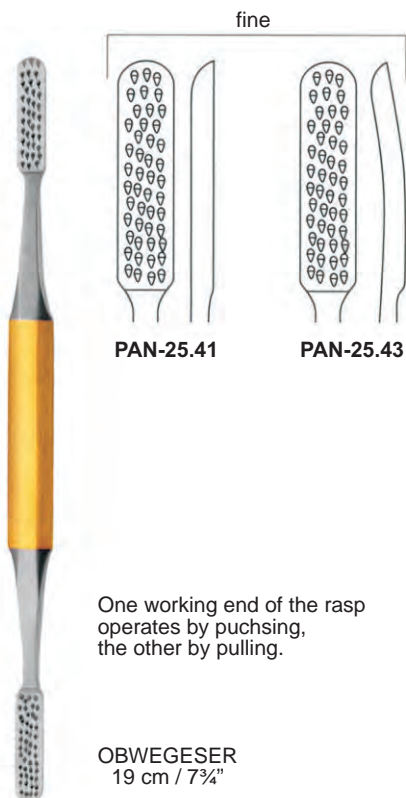

**PAN-25.41**

**PAN-25.43**

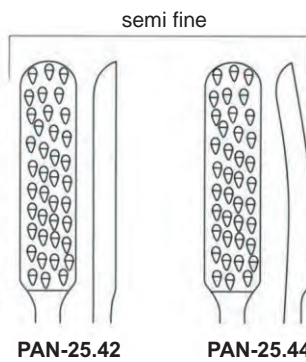

**PAN-25.42**

**PAN-25.44**

One working end of the rasp operates by pushing, the other by pulling.

**OBWEGESER**  
19 cm / 7¾"

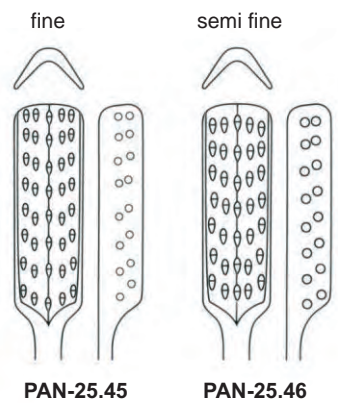
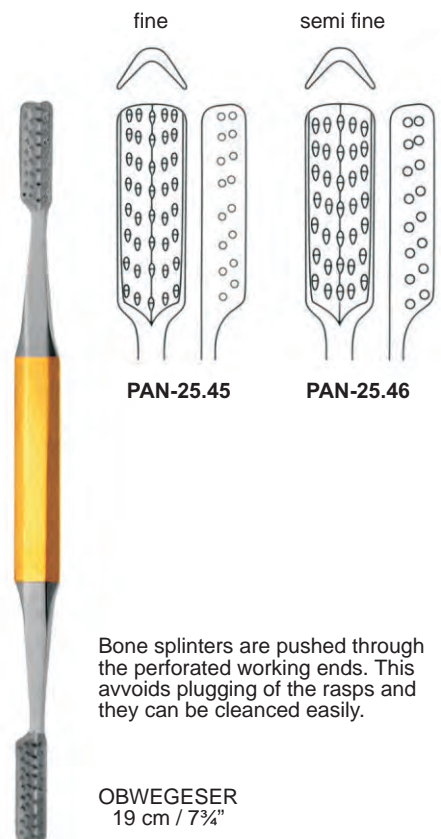

**PAN-25.45**

**PAN-25.46**

Bone splinters are pushed through the perforated working ends. This avoids plugging of the rasps and they can be cleaned easily.

**OBWEGESER**  
19 cm / 7¾"



**Nasal Rasps**  
 Raspadores nasales  
 Râpes nasales  
 Raspe nasali

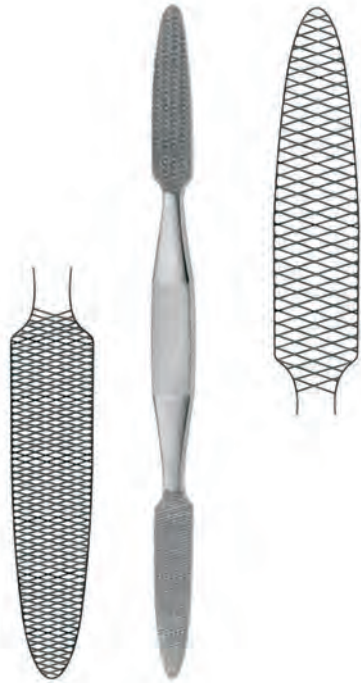

**CONVERSE**  
**PAN-25.65**  
 18.5 cm / 7¼"

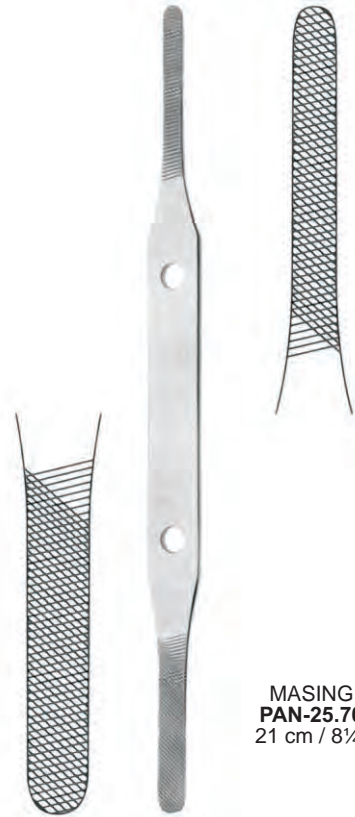

**MASING**  
**PAN-25.70**  
 21 cm / 8¼"

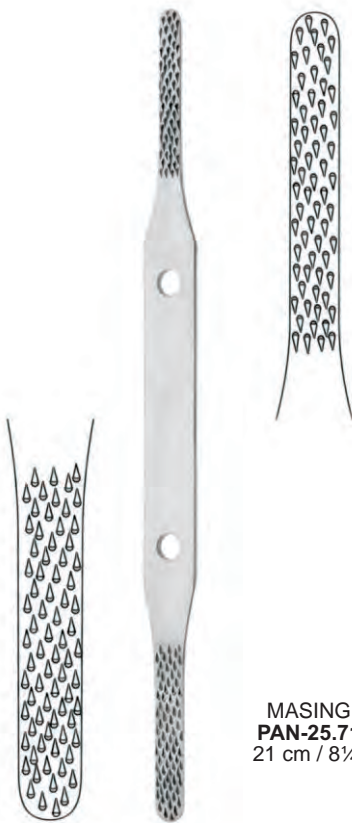

**MASING**  
**PAN-25.71**  
 21 cm / 8¼"



**GUBISCH FOMON**  
**PAN-26.30**  
 20 cm / 8"

Fig. 5

Fig. 2

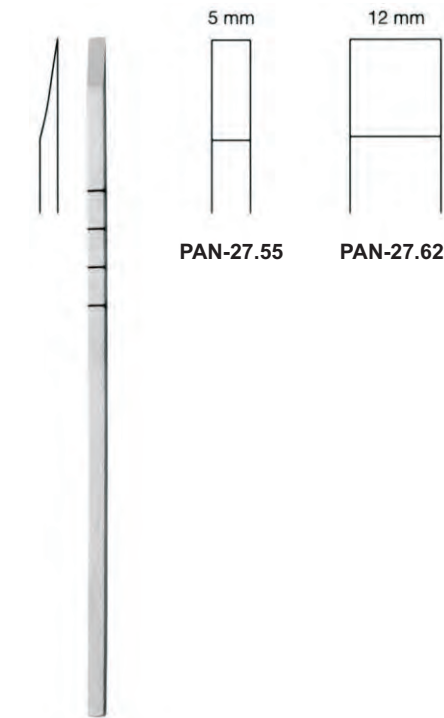

**COTTLE GUBISCH**  
18 cm / 7 1/8"

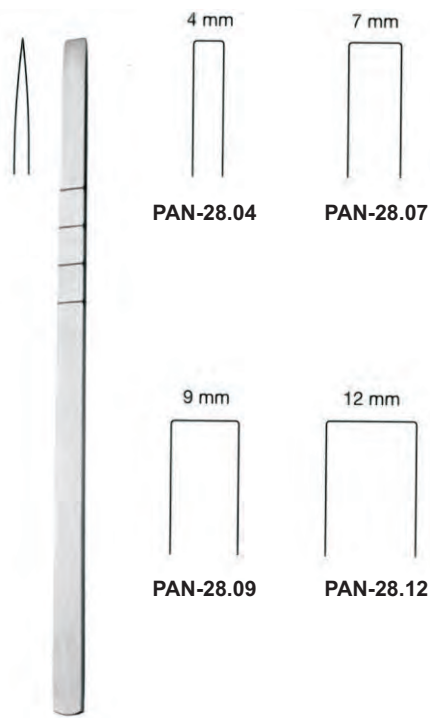

**COTTLE**  
18 cm / 7 1/8"

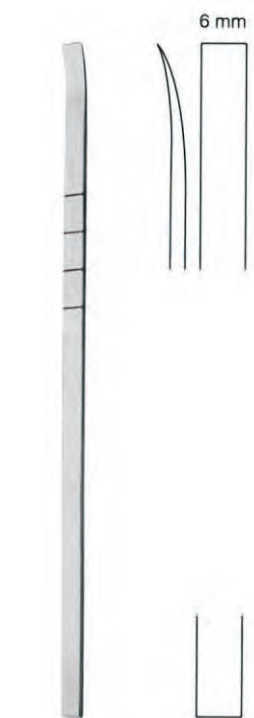

**COTTLE PAN-28.16**  
18 cm / 7 1/8"

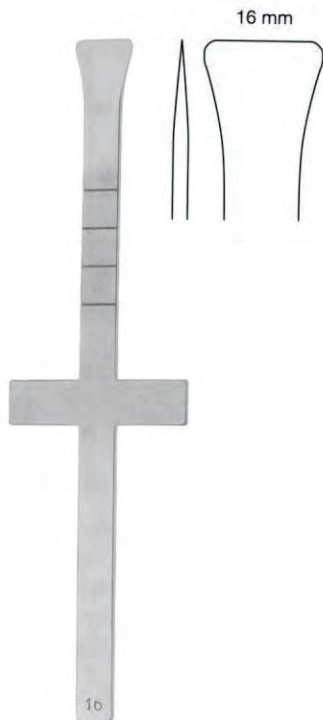

**COTTLE PAN-28.20**  
18 cm / 7 1/8"

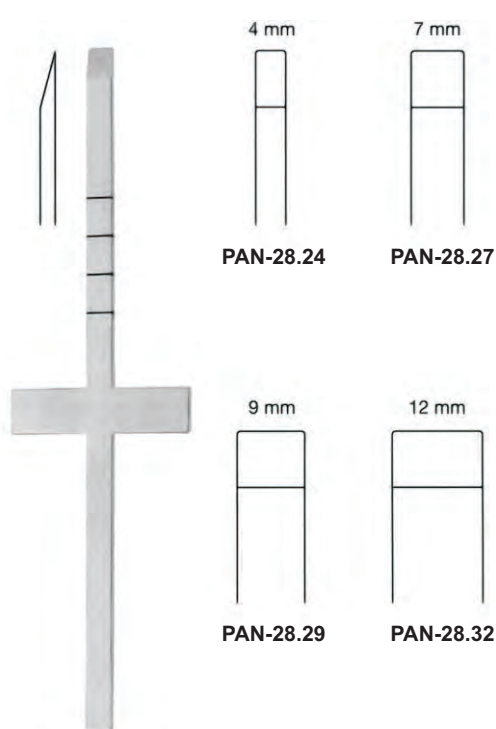

**COTTLE**  
18 cm / 7 1/8"

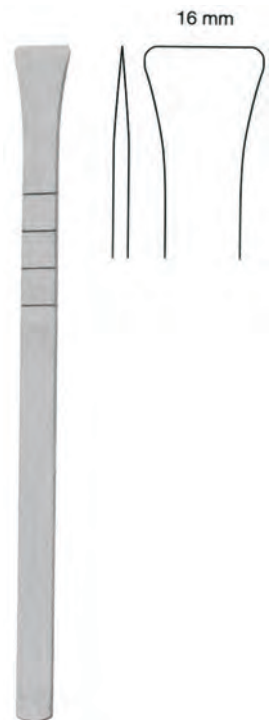

**COTTLE PAN-28.38**  
18 cm / 7 1/8"

**Osteotomes**  
 osteotomes  
 ostéotomes  
 osteotomi

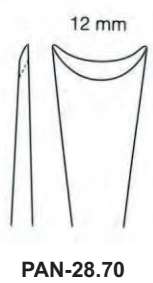
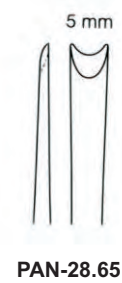
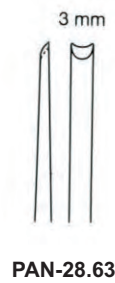

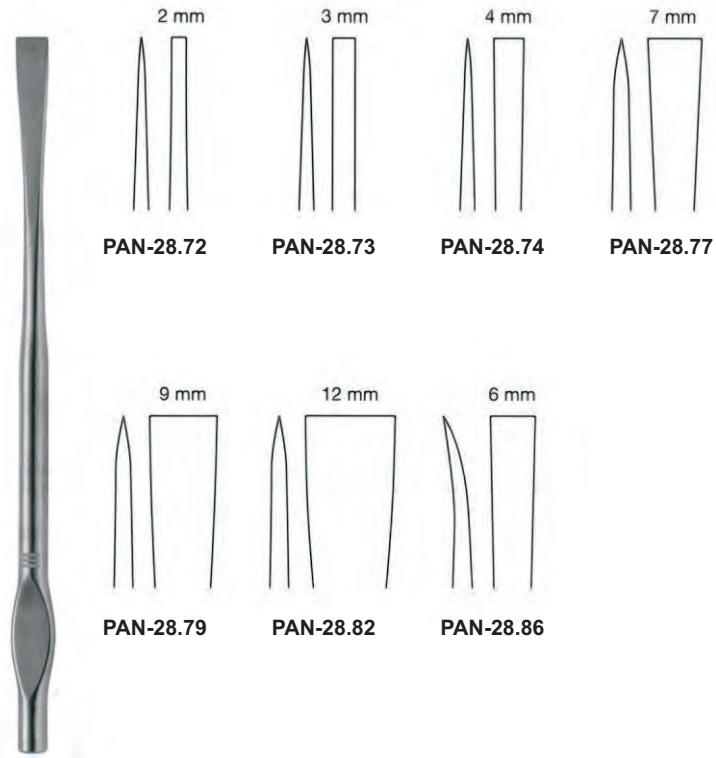

WALTER  
19cm / 7½"

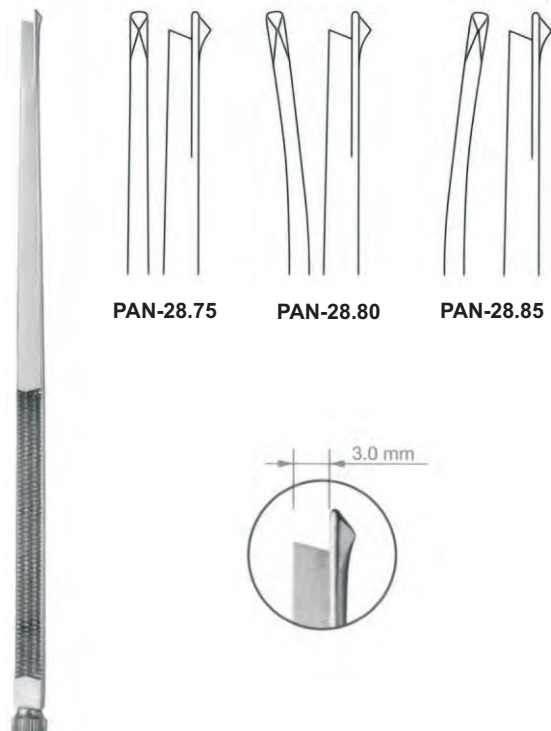

SCHROM  
19.5 cm / 7¾"



**Septum Forceps**

Pinzas para tabique nasal  
Pinces pour la cloison nasale  
Pinze per il setto nasale



ASCH  
PAN-29.21  
22 cm / 8¾"



COTTLE FOMON  
PAN-30.24  
21 cm / 8¼"



WALSHAM "UNIVERSAL"  
PAN-30.21  
23 cm / 9"



PAN-30.22  
23 cm / 9"

PAN-30.23  
23 cm / 9"

WALSHAM

**Septum Forceps**  
Pinzas para tabique nasal  
Pincas pour la cloison nasale  
Pinze per il setto nasale

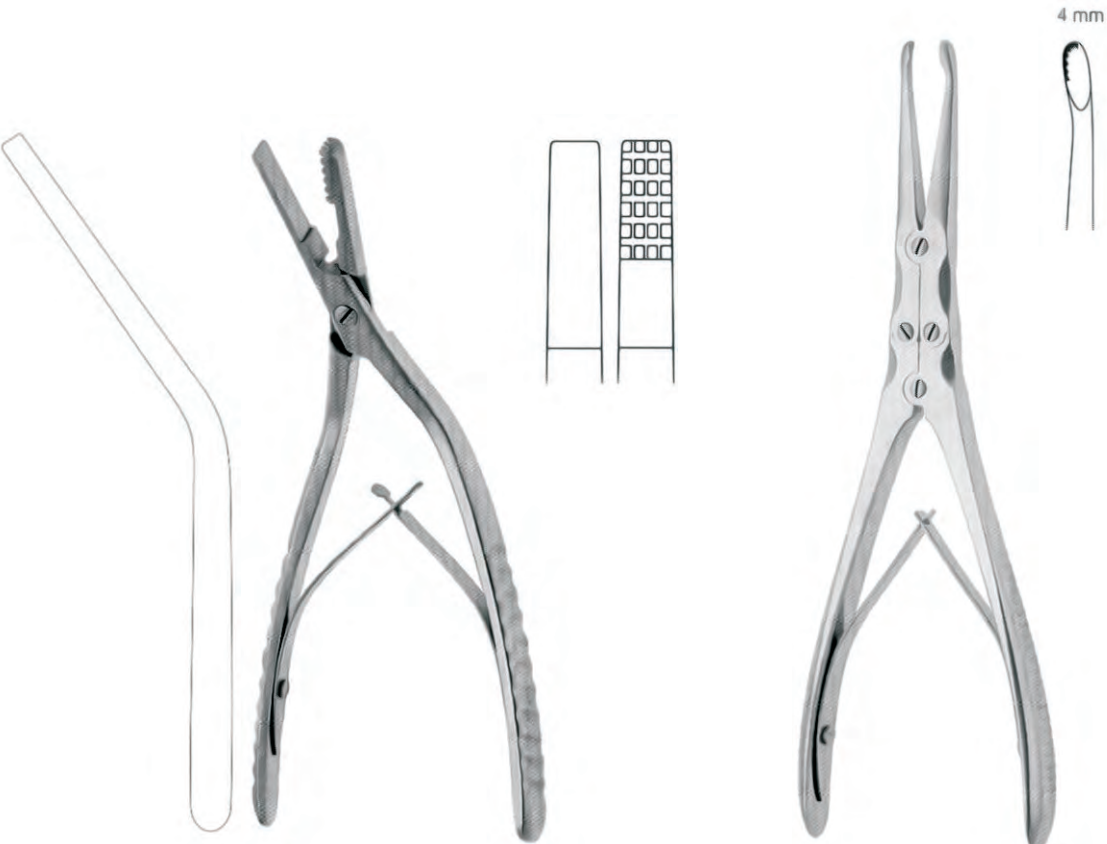

OBWEGESER  
**PAN-29.23**  
18.5 cm / 7¼"

OBWEGESER  
**PAN-30.34**  
21 cm / 8¼"

**Cartilage and Bone Instruments**  
 Instrumentos para cartilago y huesos  
 Instruments á cartilage et os  
 Strumenti per cartilagine e ossa

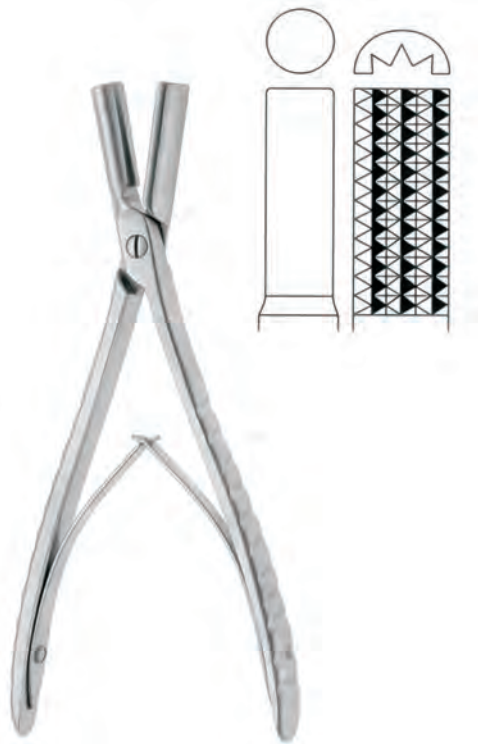

**OBWEGESER**  
**PAN-29.35**  
 17.5 cm / 7"



**OBWEGESER**  
**PAN-29.36**  
 17.5 cm / 7"



**RUBIN**  
**PAN-30.30**  
 20 cm / 8"



**RUBIN**  
**PAN-30.72**  
 20 cm / 8"

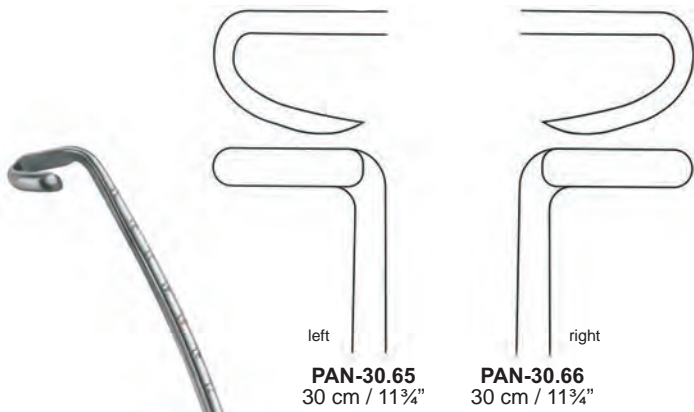

**OBWEGESER**

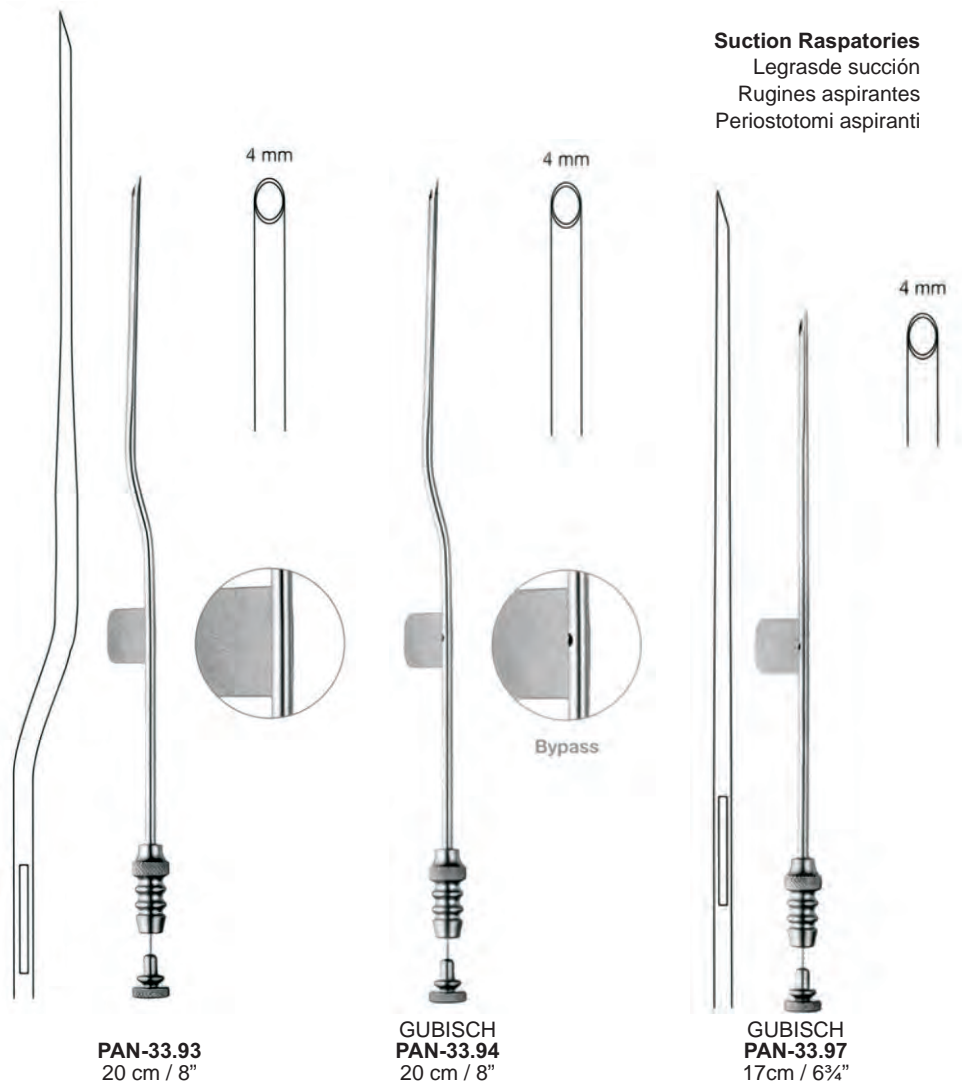

**Raspatories**

Legras  
Rugines  
Periostotomi



**COTTLE**  
**PAN-31.19**  
18 cm / 7 1/8"



**COTTLE**  
**PAN-31.20**  
18 cm / 7 1/8"



**JOSEPH MASING**  
**PAN-31.48**  
22 cm / 8 3/4"



**PAN-31.55**  
18 cm / 7 1/8"



**PAN-31.60**  
17 cm / 6 3/4"



**CONVERSE**  
**PAN-31.65**  
18 cm / 7 1/8"

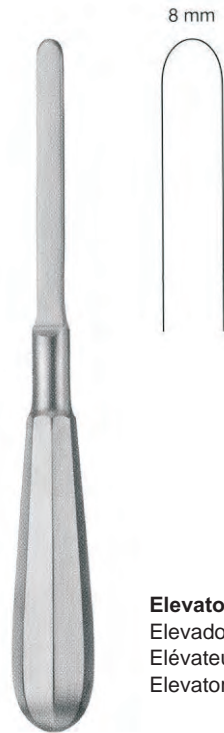

**BOIES**  
**PAN-31.69**  
19 cm / 7 1/2"



**GOLDMAN**  
**PAN-31.75**  
17 cm / 6 3/4"

**Elevators**  
Elevadores  
Elévateurs  
Elevatori

**Mucosa knife and Raspatories**  
Cuchillo para mucosa y legras  
Septotome et rugines  
Cotello per mucosa e periostotomi

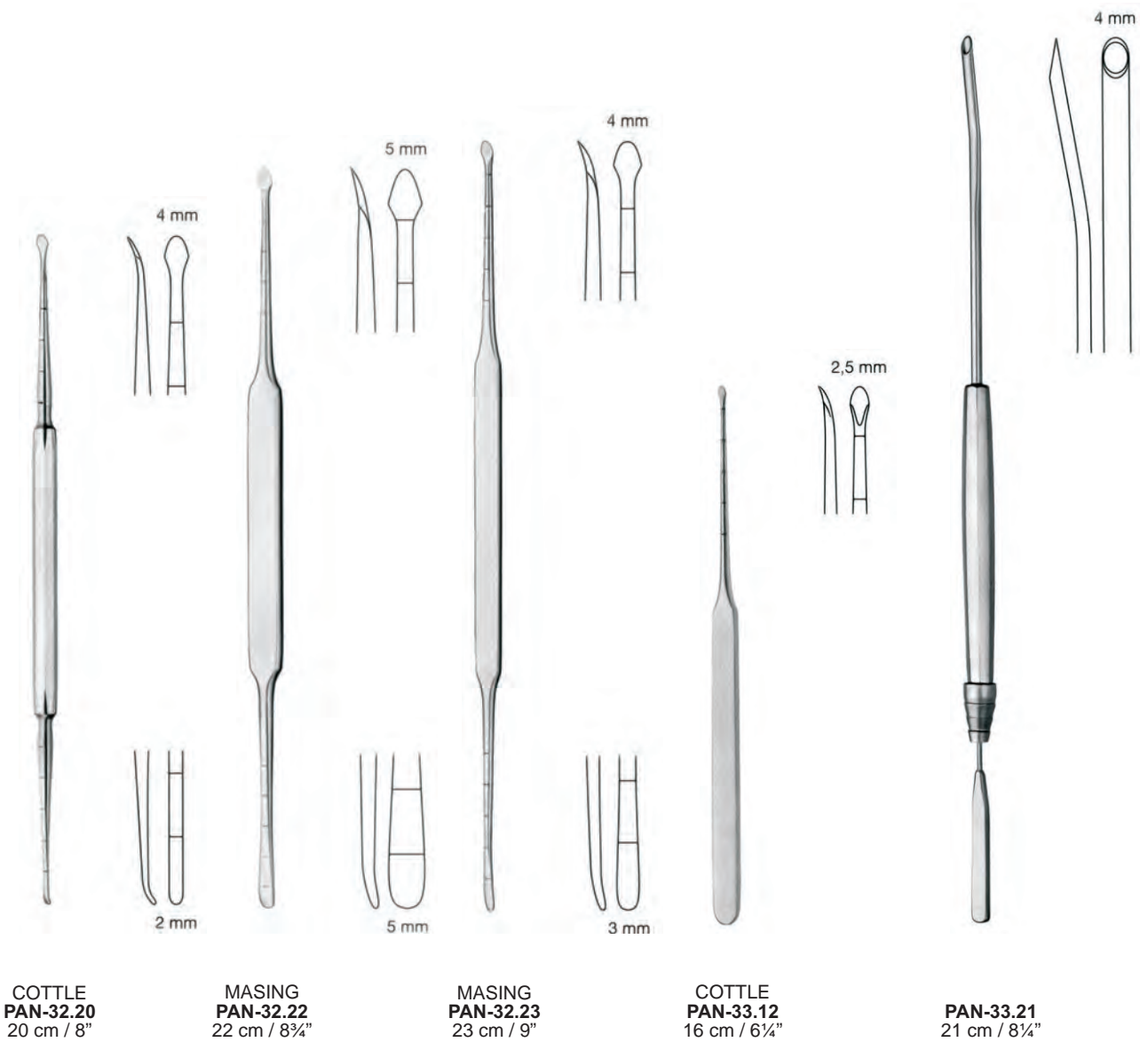



**Raspatories**  
 Legras  
 Rugines  
 Periostotomi

**Elevators**  
 Elevadores  
 Elévateurs  
 Elevatori

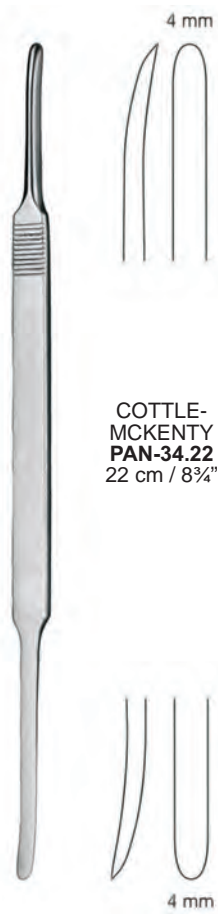



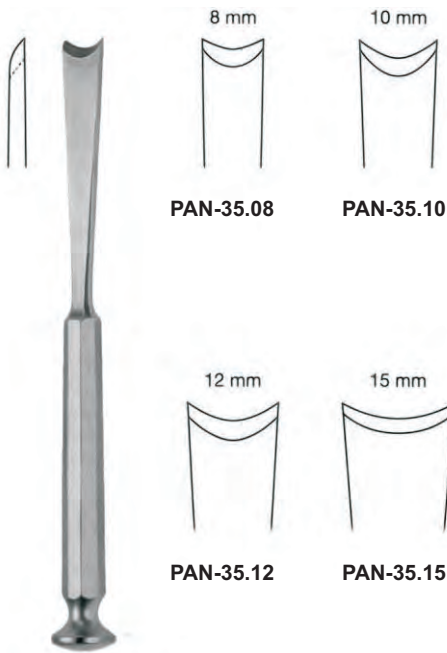

PAN-35.08

PAN-35.10

PAN-35.12

PAN-35.15

**MCINDOE**  
16 cm / 6¼"

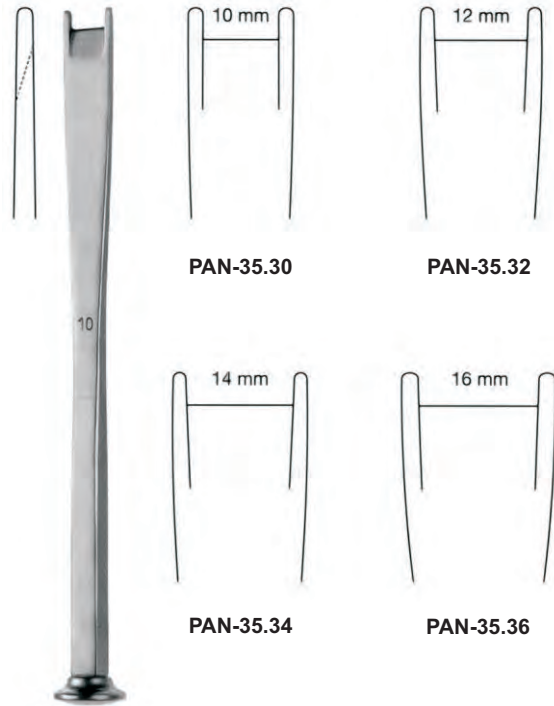

PAN-35.30

PAN-35.32

PAN-35.34

PAN-35.36

**MOBERG**  
18 cm / 7 1/8"

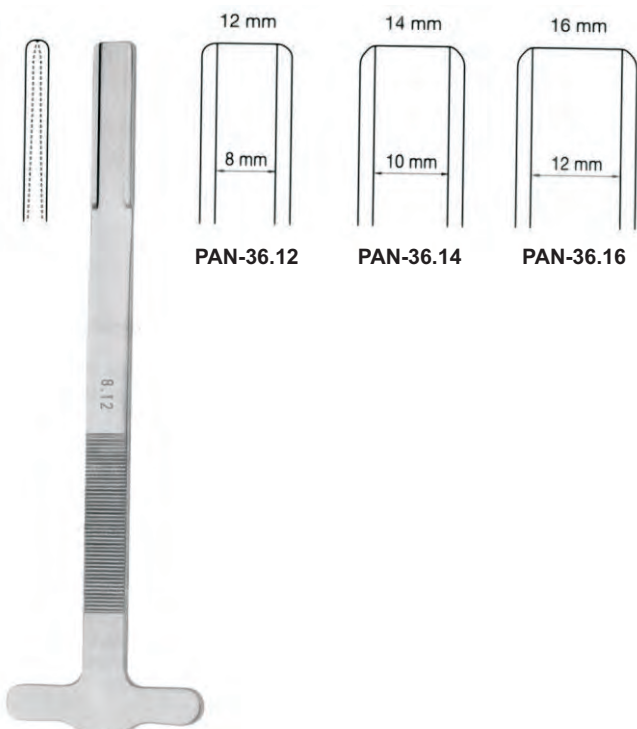

PAN-36.12

PAN-36.14

PAN-36.16

**RUBIN**  
19 cm / 7½"

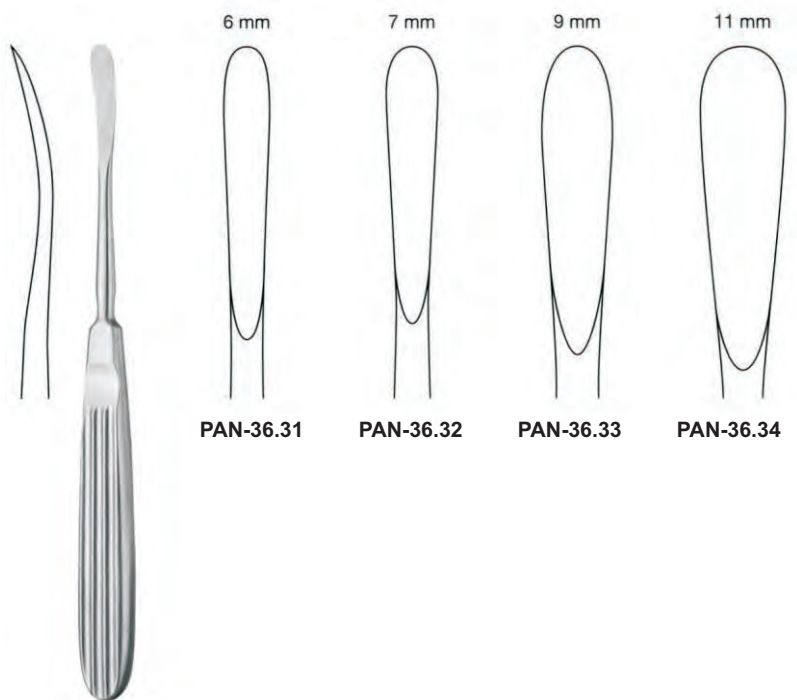

PAN-36.31

PAN-36.32

PAN-36.33

PAN-36.34

**OBWEGESER**  
17.5 cm / 7"

**Raspatories**

Legras  
Rugines  
Periostotomi



**HARGIS**  
**PAN-36.35**  
19 cm / 7½"



**OBWEGESER**  
18 cm / 7 1/8"



**PAN-36.36**



**PAN-36.37**



**OBWEGESER**  
**PAN-36.38**  
17.5 cm / 7"



**OBWEGESER**  
17.5 cm / 7"



**PAN-36.39**

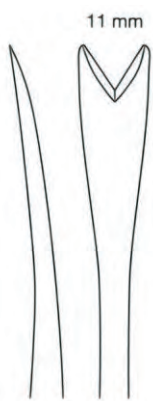

**PAN-36.40**



**OBWEGESER**  
20 cm / 8"



**PAN-36.41**

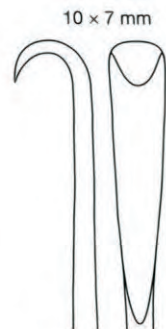

**PAN-36.42**

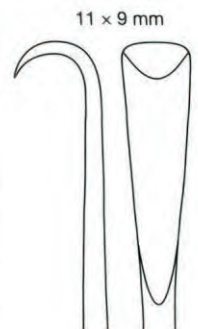

**PAN-36.43**

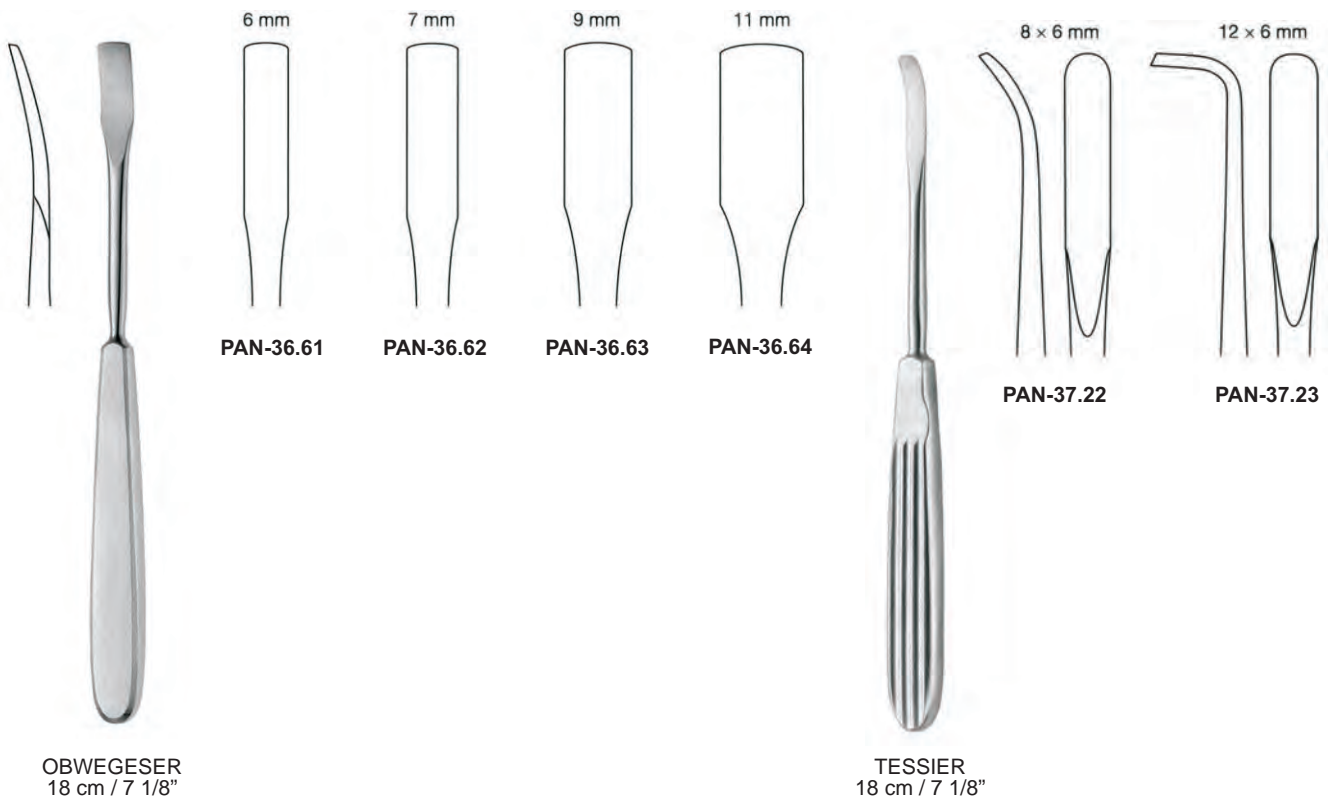
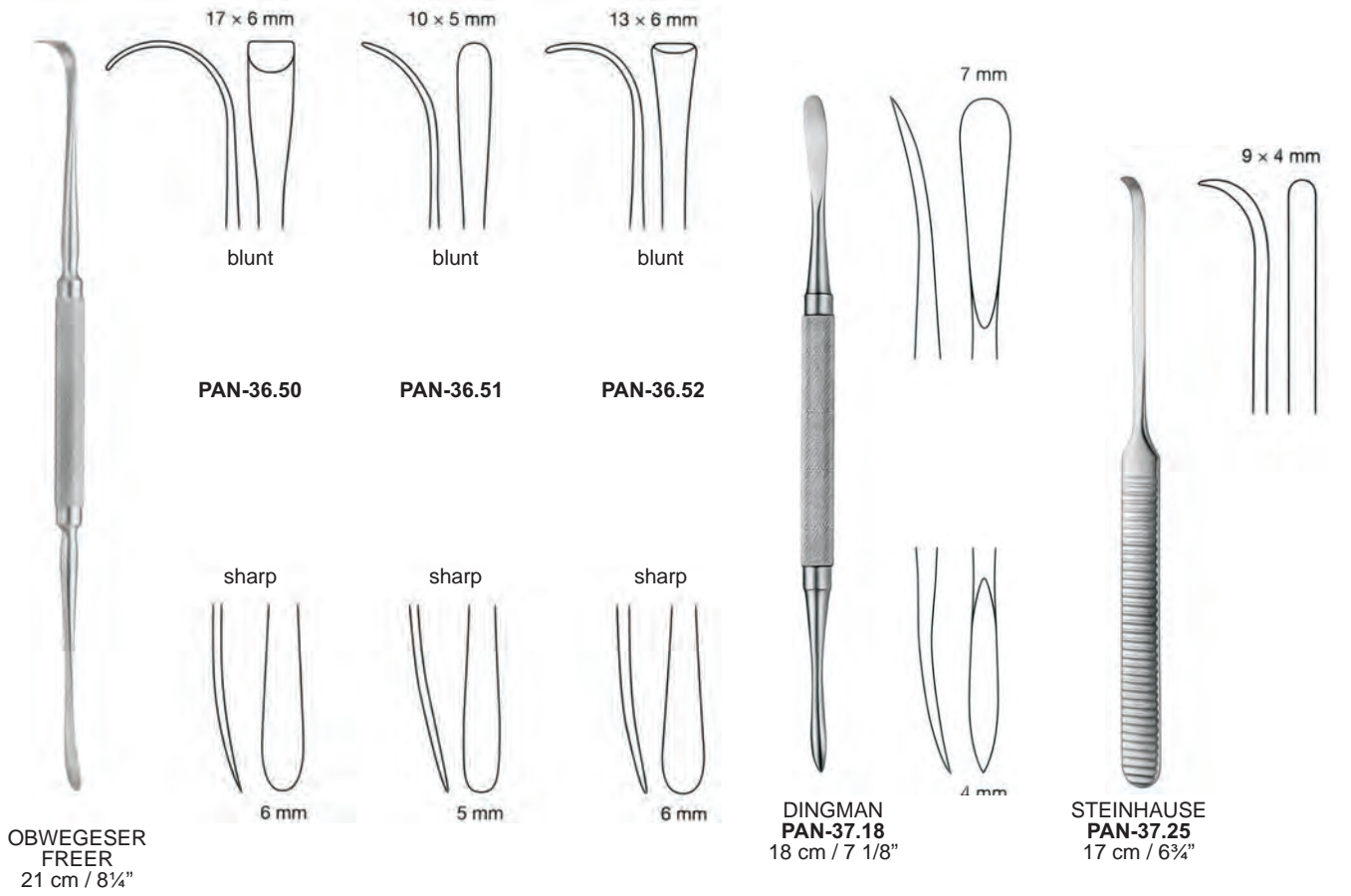

**Chisels**  
Cinceles  
Gouges  
Sgorbie



FOMON



**PAN-38.17**  
17 cm / 6¾"



**PAN-38.19**  
17 cm / 6¾"



**PAN-38.20**  
17 cm / 6¾"



SILVER  
18 cm / 7 1/8"



**PAN-40.01**

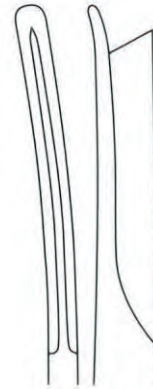

**PAN-40.02**

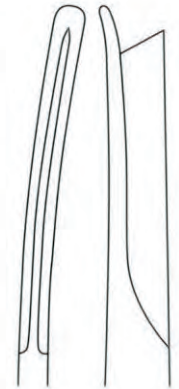

**PAN-40.03**



CINELLI  
16 cm / 6¼"



**PAN-39.10**



**PAN-39.12**



**PAN-39.14**



**PAN-39.16**



BLUME  
**PAN-40.20**  
18 cm / 7 1/8"

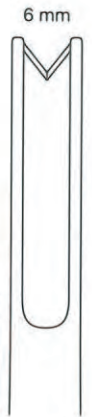

**Chisels and Osteotomes**  
 Cinceles y osteotomos  
 Gouges et ostéotomes  
 Sgorbie e osteotomi



**GUBISCH**  
**PAN-40.53**  
 18.5 cm / 7¼"

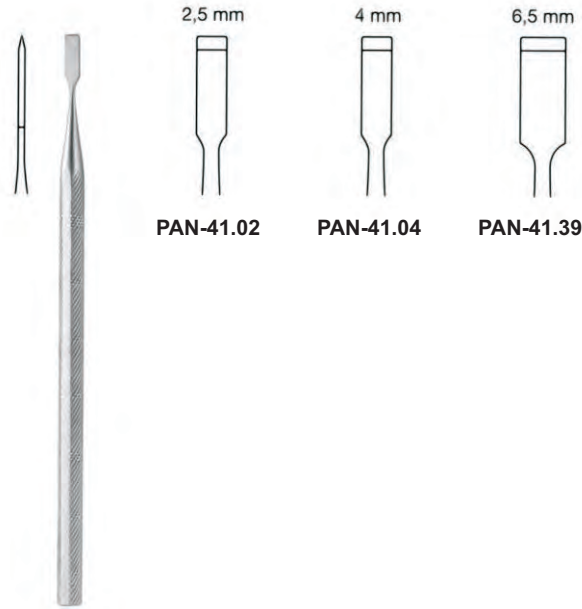

2,5 mm  
**PAN-41.02**

4 mm  
**PAN-41.04**

6,5 mm  
**PAN-41.39**

**OBWEGESER**  
 15 cm / 6"

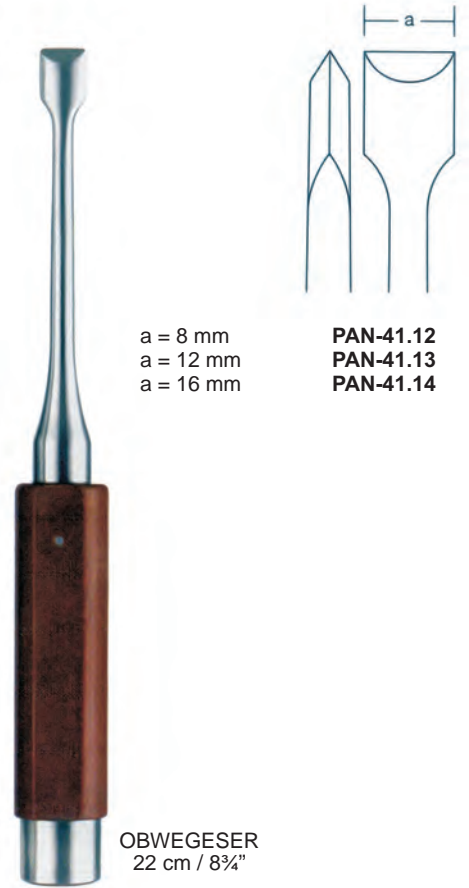

a = 8 mm  
**PAN-41.12**  
 a = 12 mm  
**PAN-41.13**  
 a = 16 mm  
**PAN-41.14**

**OBWEGESER**  
 22 cm / 8¾"

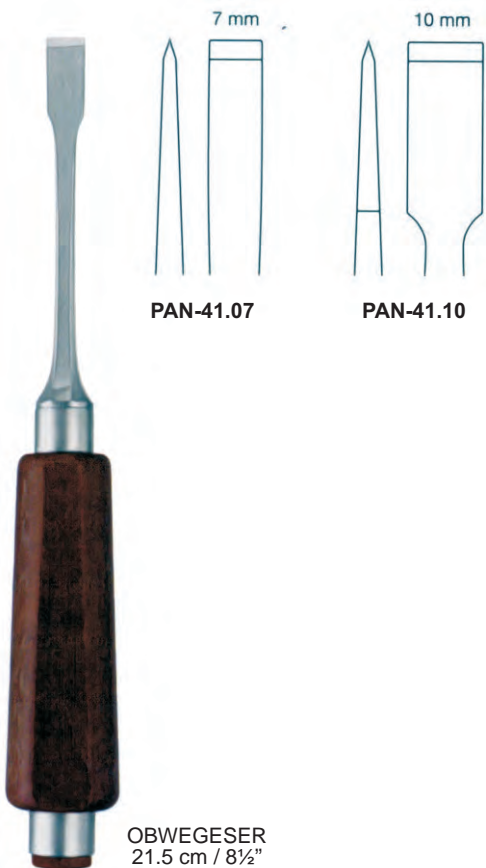

7 mm  
**PAN-41.07**

10 mm  
**PAN-41.10**

**OBWEGESER**  
 21.5 cm / 8½"

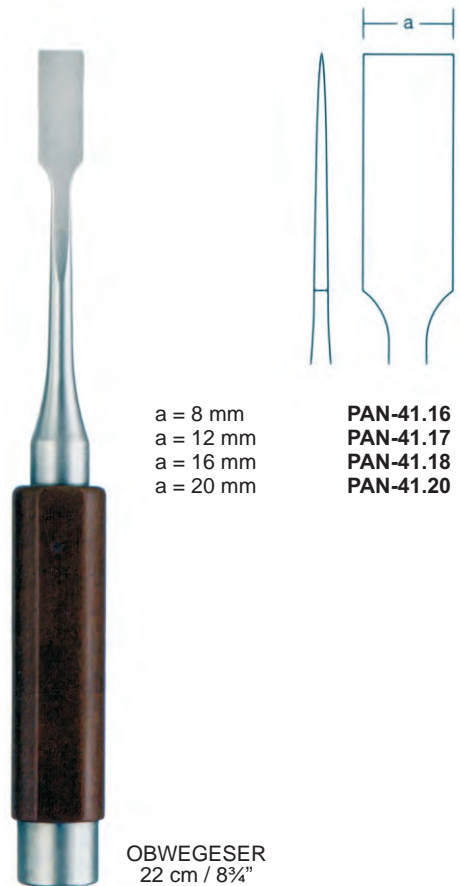

a = 8 mm  
**PAN-41.16**  
 a = 12 mm  
**PAN-41.17**  
 a = 16 mm  
**PAN-41.18**  
 a = 20 mm  
**PAN-41.20**

**OBWEGESER**  
 22 cm / 8¾"



**Osteotomes**  
 Osteotomes  
 Ostéotomes  
 Osteotomi

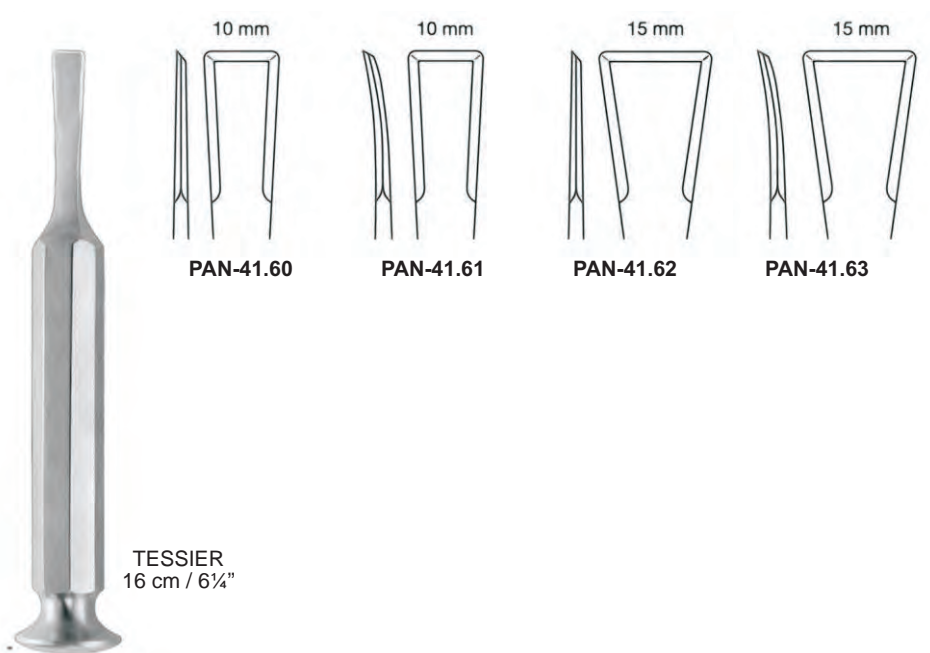
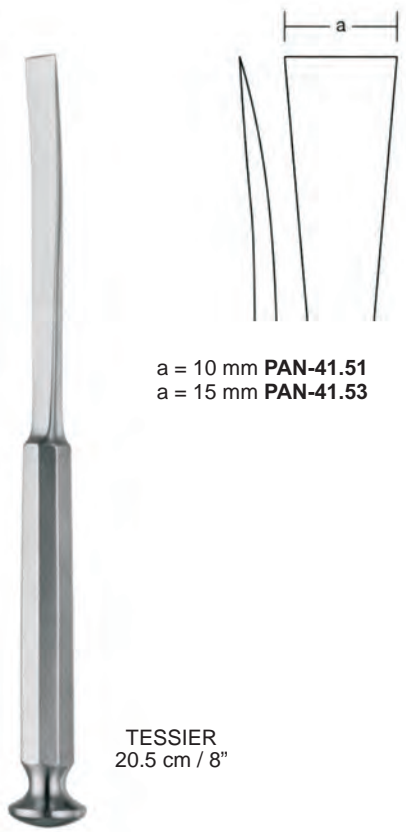
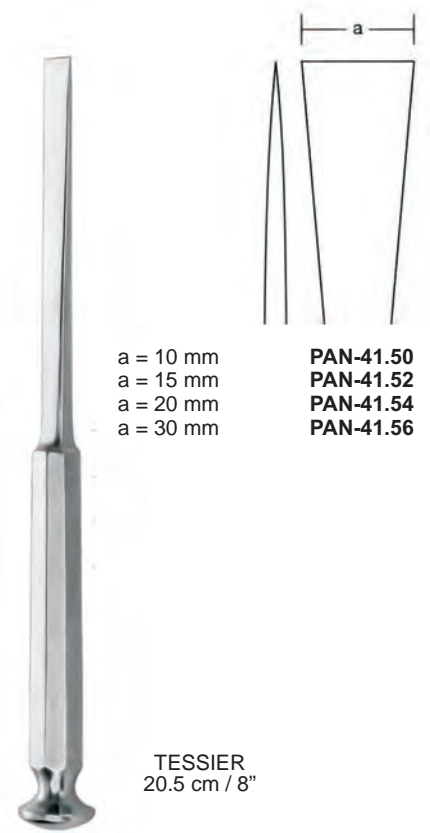
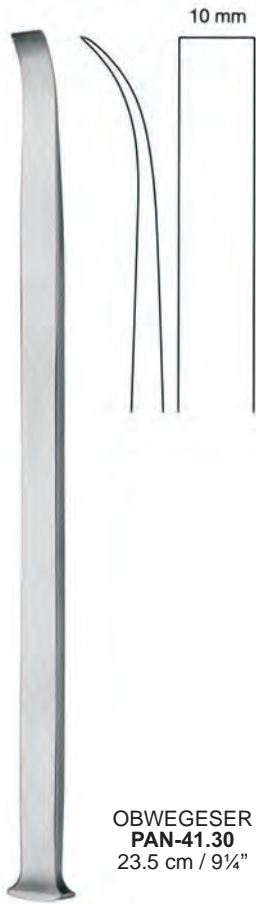



OBWEGESER  
 PAN-42.29  
 11 cm / 9"

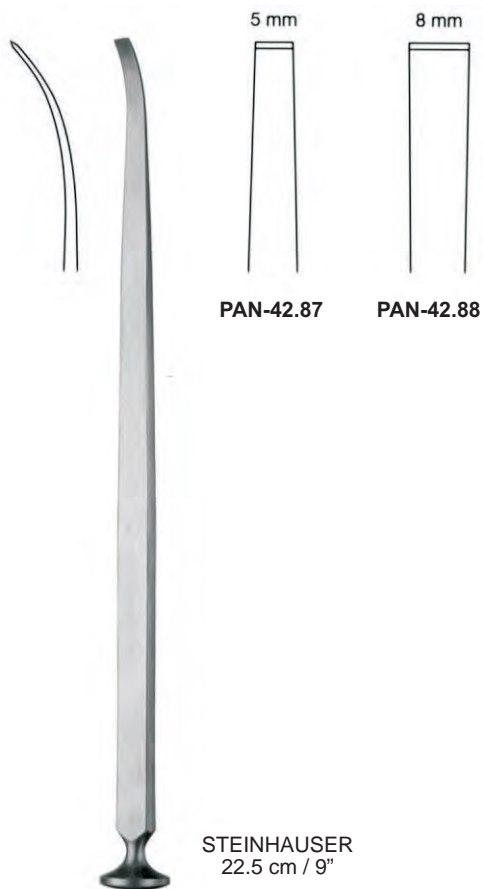

PAN-42.87 PAN-42.88

STEINHAUSER  
 22.5 cm / 9"

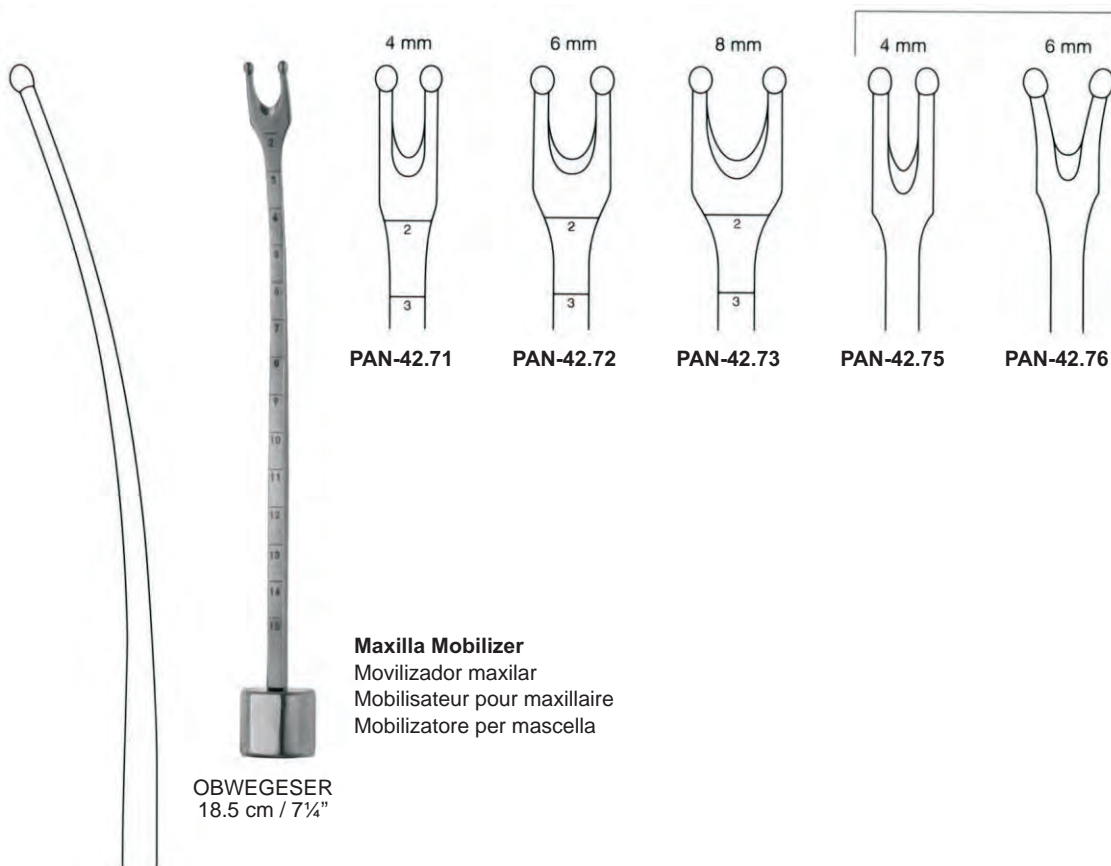

PAN-42.71 PAN-42.72 PAN-42.73 PAN-42.75 PAN-42.76

**Maxilla Mobilizer**  
 Movilizador maxilar  
 Mobilisateur pour maxillaire  
 Mobilizzatore per mascella

OBWEGESER  
 18.5 cm / 7 1/4"



**Cylinder Osteotomes**  
 Osteotomes cilíndricos  
 Ostéotomes cylindriques  
 Osteotomi cilindrici

Ø 12 mm



SHEPARD  
**PAN-42.02**  
 12 cm / 4¾"



SHEPARD  
**PAN-42.11**  
 11 cm / 4 3/8"



Ø = 5 mm  
 Ø = 6 mm  
 Ø = 8 mm

SHEPARD



12.5 cm / 5"  
**PAN-42.05**  
**PAN-42.06**  
**PAN-42.08**



14 cm / 5½"  
**PAN-42.12**  
**PAN-42.13**  
**PAN-42.14**



14.5 cm / 5¾"  
**PAN-42.15**  
**PAN-42.16**  
**PAN-42.18**

**Cartilage and Bone Instruments**  
 Instrumentos para cartilago y huesos  
 Instruments à cartilage et os  
 Strumenti per cartilagine e ossa

Bone mill with assembling wrench  
 Trituradora de hueso con llave de montaje  
 Moulin à os avec clé de montage  
 Trita ossa con chiave per montaggio



65 x 30 x 30 mm

**COTTLE**  
**PAN-34.70**



**PAN-34.75**  
Ø 68 x 110 mm



Enables crushing of compact bone pieces  
 Permite moler fragmentos óseos  
 Pour broyage des fragments d'os  
 Rende possibile tritare frammenti ossei

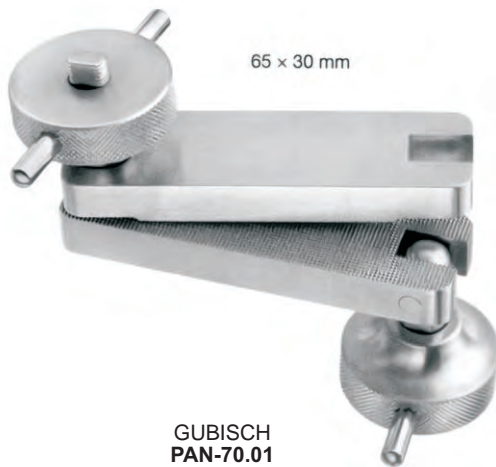

65 x 30 mm

**GUBISCH**  
**PAN-70.01**



85 x 55 x 10 mm

**PAN-70.75**

**Knives**  
Cuchillos  
Couteaux  
Coltelli

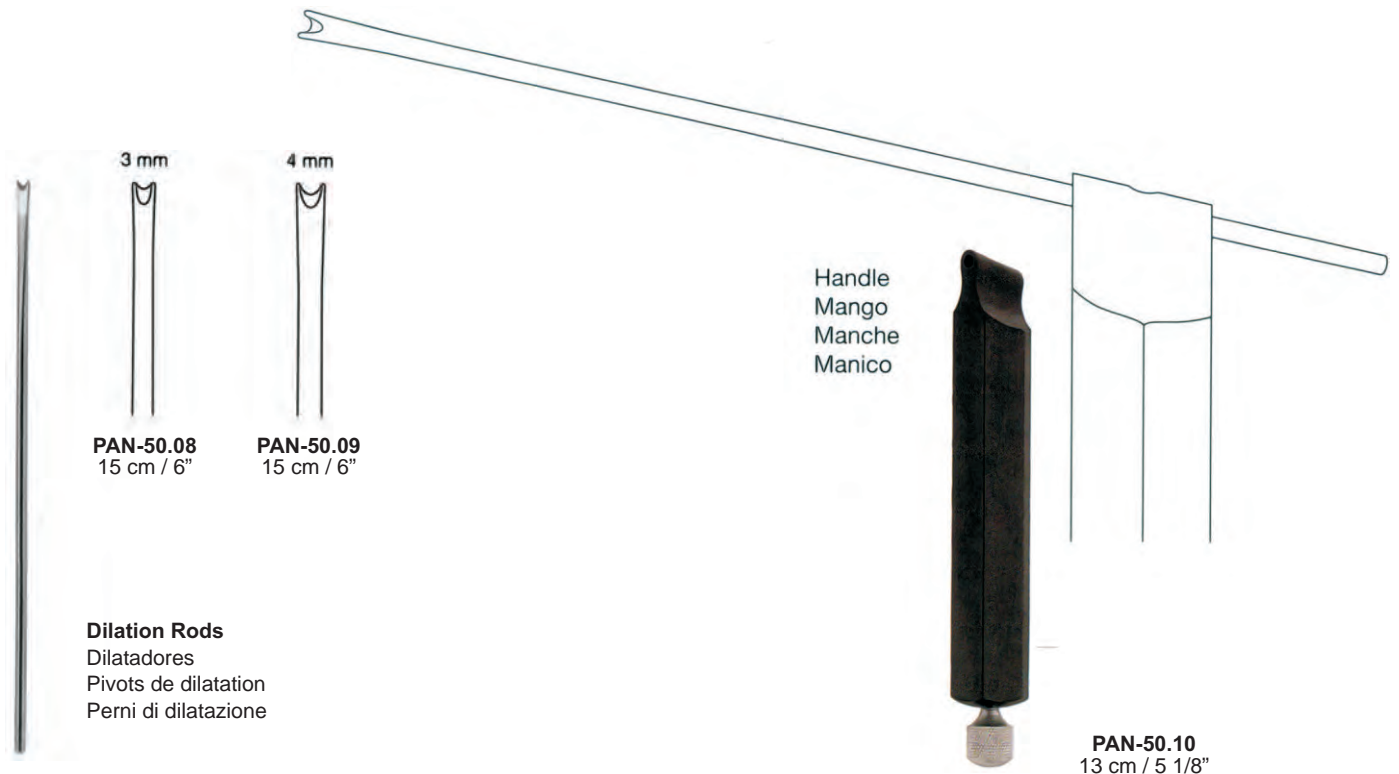
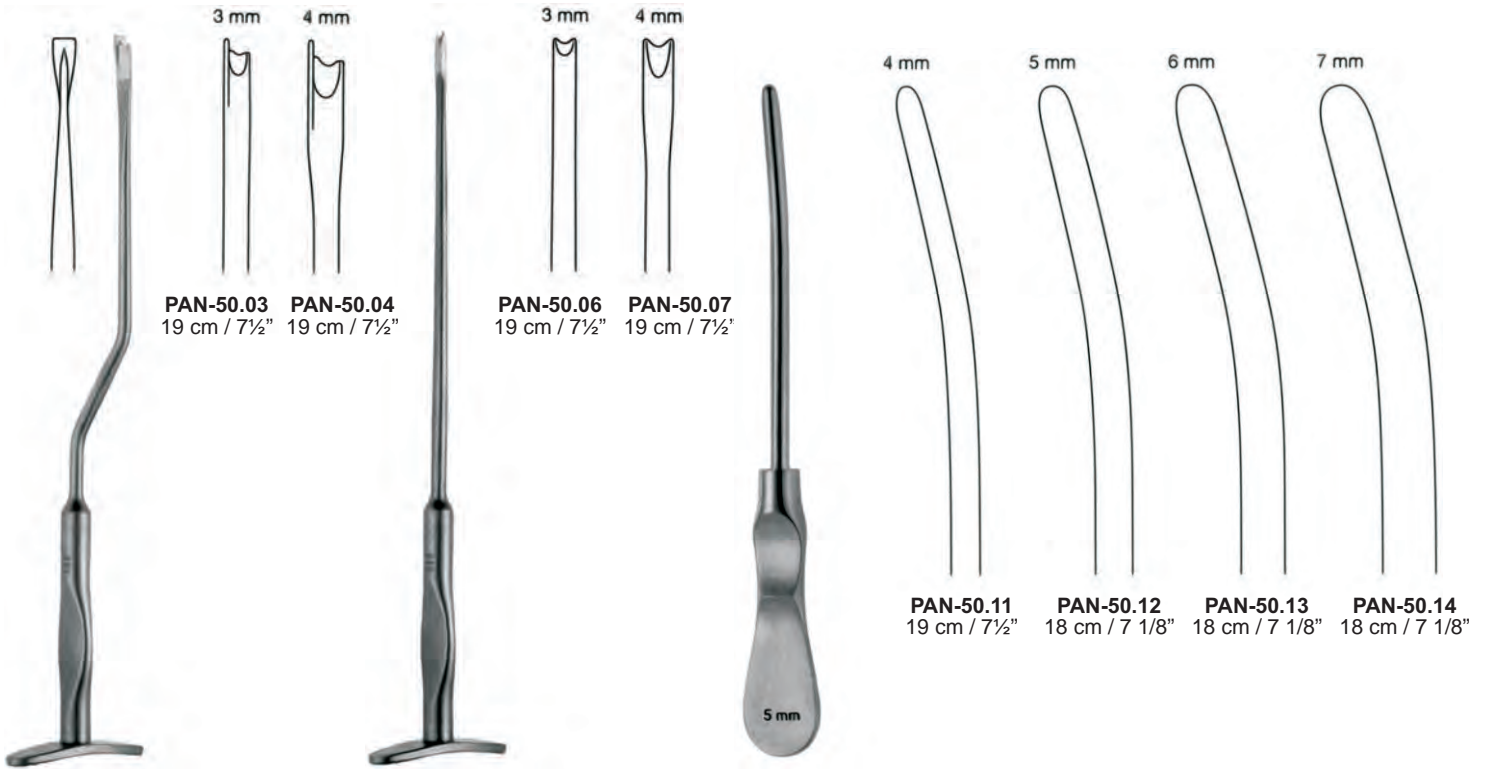



25 cm / 10"

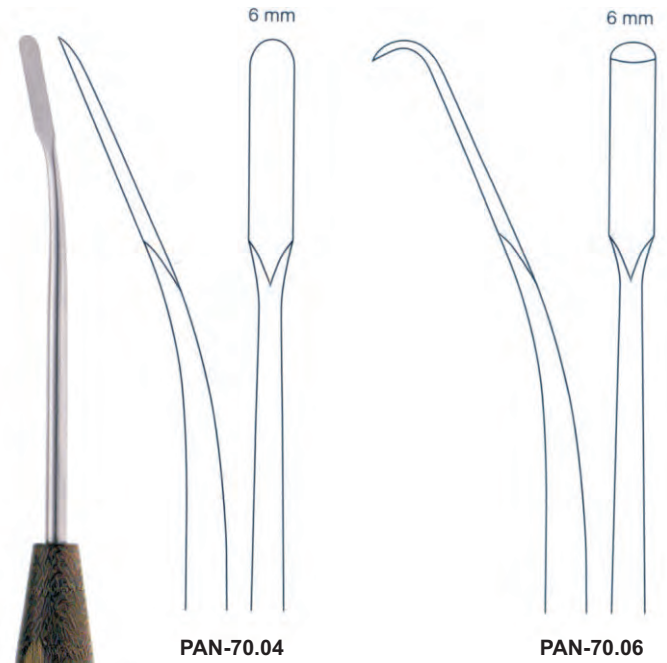

25 cm / 10"

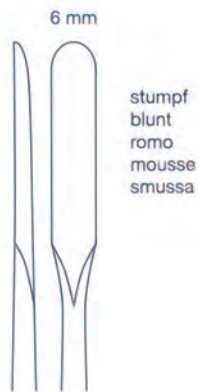

PAN-70.08  
25 cm / 10"

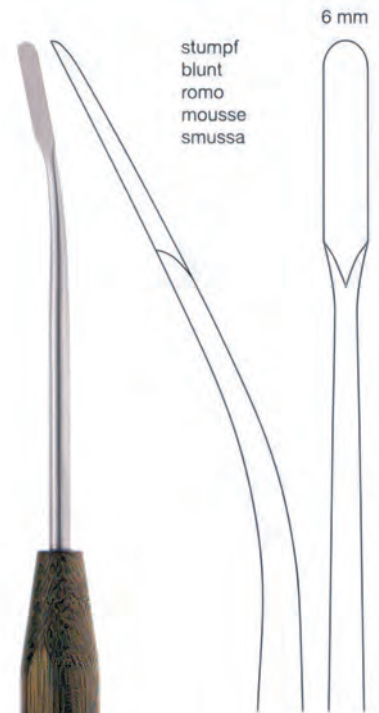

PAN-70.09  
25 cm / 10"

**Dissectors**  
Disectores  
Dissecteurs  
Dissettori

## Nerve Hooks

Ganchitos para nervios

Crochets à nerfs

Uncini per nervi

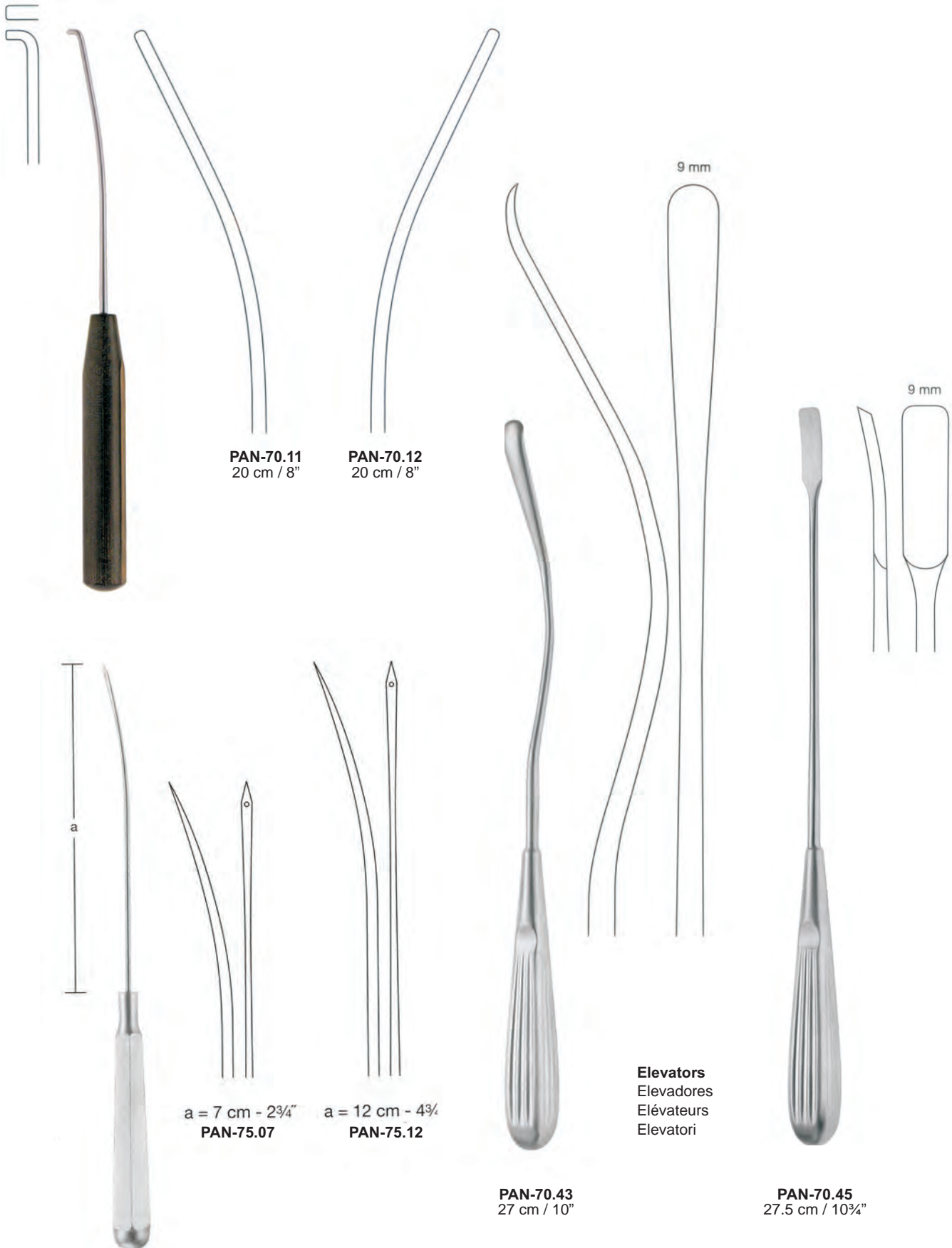



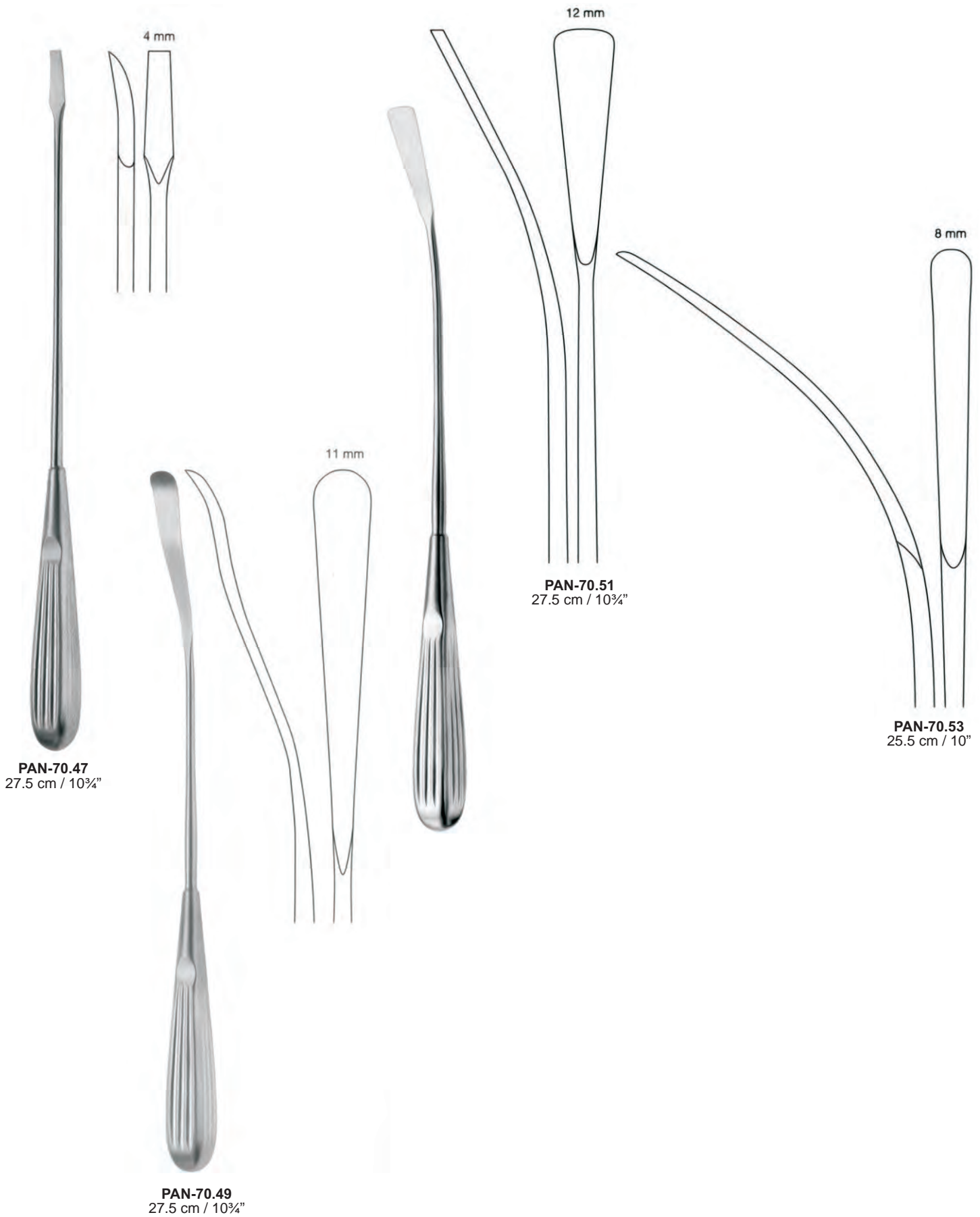



**Elevators**  
 Elevadores  
 Elévateurs  
 Elevatori

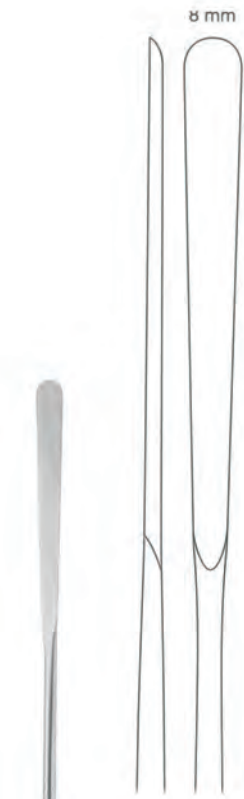

**PAN-70.54**  
 28 cm / 11"



**PAN-70.55**  
 27 cm / 10¾"



Tubing connection  
 Empalme de tubo  
 Embout de tuyaux  
 Attacco di tubo

**PAN-70.59**  
 27.5 cm / 10¾"

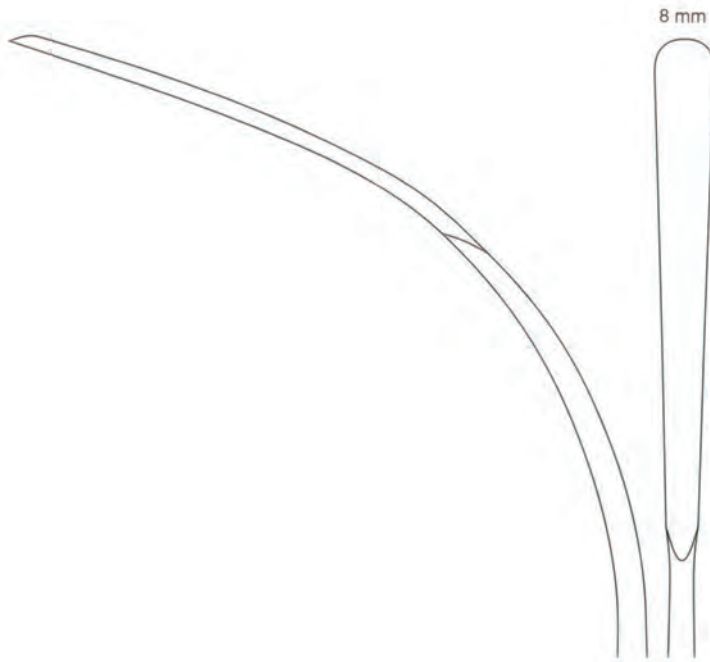

**PAN-70.57**  
 24 cm / 9½"



**Grasping Forcepsn and Hook scissors**  
 Pinzas para agarrar y tijeras de gancho  
 Pincas à saisir et ciseaux à crochet  
 Pinze per afferrare e forbici a gancio

Hook scissors  
 Tijeras de gancho  
 Ciseaux à crochet  
 Forbici a gancio

12 cm - 4¾"



curved left  
 curva izquierdo  
 courbes à gauche  
 curva sinistra

curved right  
 curva derecho  
 courbes à droite  
 curva destra



PAN-70.15

PAN-70.16



Grasping forceps  
 Pinzas para agarrar  
 Pincas à saisir  
 Pinze per afferrare

12 cm - 4¾"

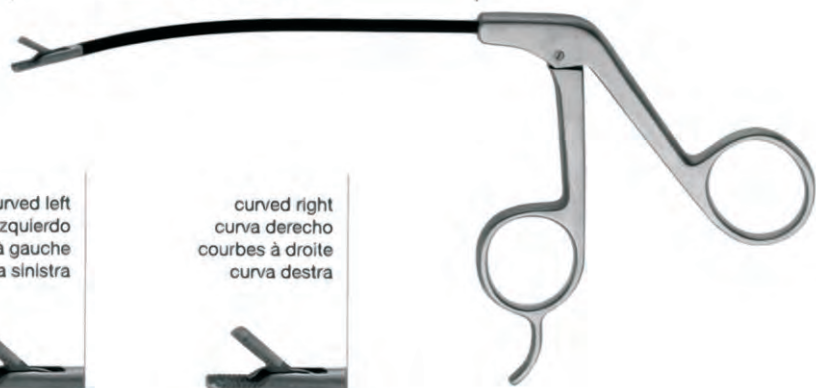

curved left  
 curva izquierdo  
 courbes à gauche  
 curva sinistra

curved right  
 curva derecho  
 courbes à droite  
 curva destra



PAN-70.17

PAN-70.18

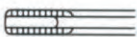

**Lip and Cleft Palate Instruments**

Instrumentos para labios y Fisuras paladares

Instruments pour lèvres et fissures palatines

Strumenti per labbra e fessure del palato



**BLOCKSMA**  
18 cm / 7 1/8"

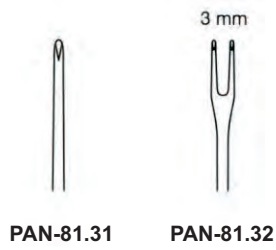

**PAN-81.31**

**PAN-81.32**



14 cm / 5 1/2"

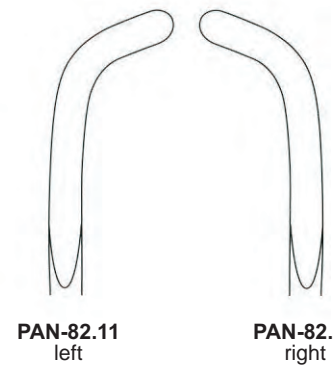

**PAN-82.11**  
left

**PAN-82.12**  
right



**KAHERE**  
**PAN-82.20**  
17 cm / 6 3/4"



**MCINDOE**  
**PAN-82.25**  
16.5 cm / 6 1/2"

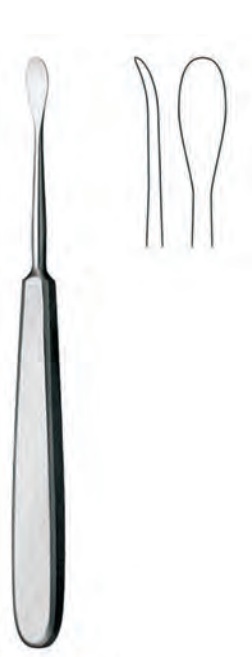

**WANG**  
**PAN-82.80**  
15.5 cm / 6 1/8"



MOLT

**PAQ-06.10**  
10 cm / 4"  
for children

**PAQ-07.15**  
15 cm / 6"  
for adults



ROSER KONIG  
**PAQ-13.45**  
16 cm / 6 1/4"



DENHART  
**PAQ-14.60**  
13 cm / 5 1/8"

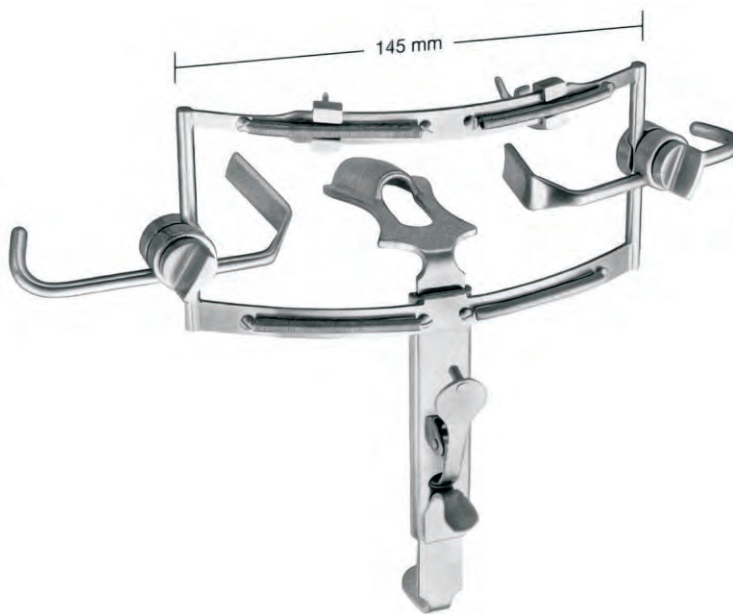

DINGMAN  
**PAQ-18.00**



Tongue depressor  
Bajalengua  
Abaisse-langue  
Abbassalingua

**PAQ-18.11**  
55 x 25 mm  
Fig.1

**PAQ-18.12**  
60 x 27 mm  
Fig.2

**PAQ-18.13**  
70 x 30 mm  
Fig.3

**Mouth Gags**  
Abrebocas  
Ouvre-bouches  
Apribocca

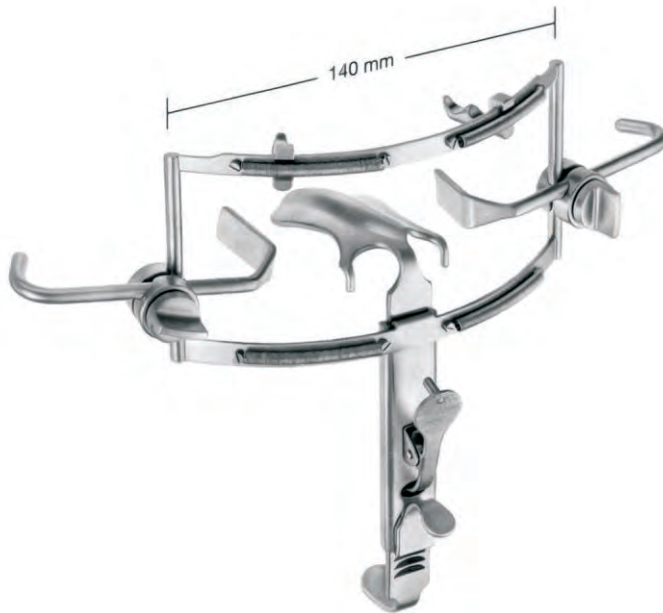

WANG  
PAQ-19.00



Tongue depressor  
Bajalengua  
Abaisse-langue  
Abbassalingua

**PAQ-19.05**  
55 x 32 mm  
Fig.1

**PAQ-19.06**  
60 x 35 mm  
Fig.2

**PAQ-19.07**  
75 x 38 mm  
Fig.3



**STERNBERG**  
**PAS-03.15**  
 14.5 cm / 5¾"



**UNIV. MINNESOTA**  
**PAS-03.34**  
 15.5 cm / 6 1/8"

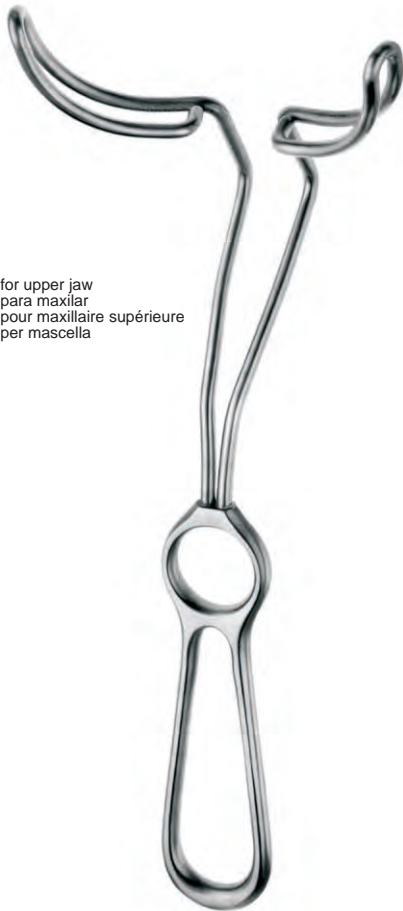

for upper jaw  
 para maxilar  
 pour maxillaire supérieure  
 per mascella

**PAS-15.21**  
 21 cm / 8¼"



for lower jaw  
 para mandibula  
 pour maxillaire inférieure  
 per mandibola

**PAS-15.26**  
 26 cm / 10¼"



Univer:  
 univer:  
 univer:  
 univer:

**PAS-15.27**  
 15 cm / 6"



**Lip and Cleft Palate Instruments**

Instrumentos para labios y Fisuras paladares

Instruments pour lèvres et fissures palatines

Strumenti per labbra e fessure del palato



**PAS-07.35**  
19 cm / 7½"



**PAS-07.36**  
19 cm / 7½"



**PAS-07.37**  
19 cm / 7½"

## **Set Suggestions**

Proposiciones de juegos

Propositions pour boîtes

proposte di sets





PA-39.01 PA-39.02 PC-16.13 PC-31.167 PC-73.14 PE-03.15 PE-05.07 PF-15.62 PF-19.12 PF-21.12 PF-42.40 PF-60.15 PF-64.16

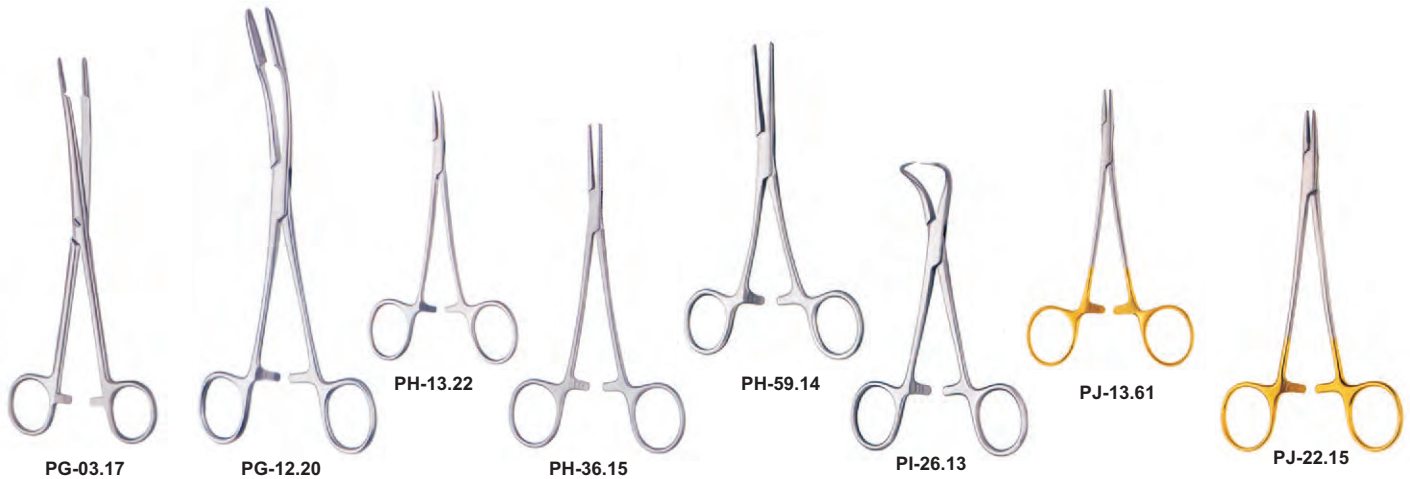

PG-03.17 PG-12.20 PH-13.22 PH-36.15 PH-59.14 PI-26.13 PJ-13.61 PJ-22.15 PM-14.45

**OPTION "A"**

- PA-39.01 GUBISCH Pen holder (13cm)
- PA-39.02 Pen for Pen holder
- PC-16.13 Operating scissors. straight sharp/blunt (13cm)
- PC-31.167 MAYO STILLE Dissecting scissors, curved (17cm)
- PC-73.14 REYNOLDS (JAMESON) Dissecting scissors. curved (14cm)
- PE-03.15 Scalpel blade. no.15 packing unit 100 pieces. sterile
- PE-05.07 Scalpel handle. no.7 (16.5cm)
- PF-15.62 ADSON Delicate forceps dressing/Tissue (12cm)
- PF-19.12 MICRO ADSON Delicate forceps dressing/tissue. 1 x 2 teeth (12cm)
- PF-21.12 ADSON BROWN Delicate forceps dressing/tissue 7 x 7 teeth (12cm)
- PF-42.40 Forceps dressing/tissue (20cm)
- PF-60.15 NELSON Tissue grasping forceps (15cm)
- PF-64.16 GRUENWALD Forceps dressing/tissue (16cm)
- PG-03.17 Dressing Forceps- curved (17.5 cm)
- PG-12.20 GROSS Dressing Forceps- curved (20 cm)
- PH-13.22 MICRO-HALSTED Hemostatic forceps' curved (12.5cm)
- PH-36.15 LERICHE Hemostatic forceps' straight (15cm)
- PH-59.14 PEAN Hemostatic forceps' straight (14 cm)
- PI-26.13 BACKHAUS Towel clamp (13 cm)
- PJ-13.61 GUBISCH Needle holder- extra-fine (12,5cm)
- PJ-22.15 CRILE-WOOD Needle holder' fine (15 em)
- PM-14.45 Mallet made of Novotex plastic · Ø45 mm · 240 g (26 cm)
- PT-46.08 LANGEN BECK Elevator' thin· 7 mm (20 cm)
- PT-18.01 FREER Raspatory' sharp/sharp' 5 mm (19 cm)
- PT-15.05 WILLIGER Raspatory· 5 mm (16 cm)
- PT-17.04 McKENTY Raspatory· 4 mm (15 cm)
- PY-23.15 BARSKY Skin hook · 1 tooth (15 cm)
- PY-21.05 JOSEPH Delicate retractor' 2 teeth (17 cm)
- PY-25.13 GUTHRIE Delicate retractor' 2 teeth- sharp (13 cm)



PM-14.45 PT-17.04 PT-15.05 PT-18.01 PT-46.08 PY-25.13 PY-21.05 PY-23.15

**Nose Corrections**  
 Correcciones de la nariz  
 Corrections du nez  
 Correzioni nasali



PU-50.56



PAB-82.32



PAB-164.02



PAF-06.05  
 PAF-06.06  
 PAF-06.08  
 PAF-06.10



PAM-11.62



PAM-14.56



PAM-20.16



PAM-44.03



PAN-33.94



PAN-33.97



PAN-04.37



PAN-10.17



PAN-27.55



PAN-27.62



PAN-28.54



PAN-40.53



PAN-55.20



PAN-70.01



PAN-70.75

**OPTION "B"**

- PU-50.56 AIACH Forceps (16cm)
- PAB-82.32 CASTROVIEJO Calipers, measuring range 20 mm (7cm)
- PAB-164.02 DESMARRES Lid retractor, figure 2 (14cm)
- PAF-06.05 Round bowl for solutions, 40 x 20 mm, 20 cc, 18/8 stainless steel
- PAF-06.06 Round bowl for solutions, 60 x 30 mm, 20 cc, 18/8 stainless steel
- PAF-06.08 Round bowl for solutions, 80 x 40 mm, 20 cc, 18/8 stainless steel
- PAF-06.10 Round bowl for solutions, 110 x 55 mm, 20 cc, 18/8 stainless steel
- PAM-11.62 COTTLE Nasal specula, 55 mm (13cm)
- PAM-14.59 KILLIAN Nasal specula, figure 4, 90 mm (14cm)
- PAM-20.16 FREER Mucosa scalpel (16cm)
- PAM-44.03 WEIL-BLASKESLEY Ethmoid bone forceps, straight, 4.2 mm (12 cm)
- PAN-04.37 GUBISCH-KILNER Alar retractor, 10mm (8cm)
- PAN-10.17 GUBISCH-AUFRICHT Nasal hooks (17cm)
- PAN-27.55 COTTLE-GUBISCH Chisel, graduated, hollow cut, 5 mm (18cm)
- PAN-27.62 COTTLE-GUBISCH Chisel, graduated, hollow cut, 12 mm (18cm)
- PAN-28.54 FANOUS Osteotome, with thorn, 4 mm (19.5 cm)
- PAN-33.94 GUBISCH Suction raspatory, with guide and bypass (20cm)
- PAN-33.97 GUBISCH Suction raspatory, with guide (17cm)
- PAN-40.53 GUBISCH Osteotome, with aluminium handle, 3 mm (18.5 cm)
- PAN-55.20 CAPLAN Nasal septum scissors, serrated cutting edge (20cm)
- PAN-70.75 Cartilage cutting block made of teflon
- PAN-70.01 COTTLE Cartilage crusher



PC-24.164

PC-25.167

PC-39.168

PC-47.166

PAM-17.122

PAM-50.163



PAN-26.30

PAN-25.00

PAN-25.03

PAN-25.80-84

PAN-30.72

PAS-03.18

**OPTION "C"**

- PC-24.164** MAYO Dissecting scissors . supercut plus . straight ( 14 cm)
- PC-25.167** MAYO Dissecting scissors . supercut plus . curved ( 17 cm)
- PC-39.168** METZENBAUM Dissecting scissors . supercut plus . curved ( 18cm)
- PC-47.166** KELLY Dissecting scissors . supercut plus . curved ( 16cm)
- PAM-17.122** HEYMANN Rhinoplasty scissors . supercut . serrated cutting edge ( 18cm)
- PAM-50.163** FOMON Rhinoplasty scissors. supercut plus . angled downwards (13cm)
- PAN-25.00** Handle for nasal rasps figure 1-10 (14cm)
- PAN-25.03** Wrench for nasal rasp
- PAN-25.80-84** Nasal rasps Figure 1-10
- PAN-26.30** GUBISCH FOMON Nasal rasp. figure 2/5 ( 20 cm)
- PAN-30.72** GUBISCH RUBIN Septal morselizar forceps. with protective guard (20cm)
- PAS-03.18** BUCHWALD Tongue spatula (18cm)



**Nose Corrections**  
 Correcciones de la nariz  
 Corrections du nez  
 Correzioni nasali



PB-07.11 PC-17.14 PC-59.15 ? PE-06.17 PF-21.12 PF-34.32 PF-43.15 PF-60.26 PF-70.13



PG-19.20 PH-13.22 PI-25.08 PJ-45.18 PM-08.18 PT-23.04 PW-27.21 PX-39.19 PY-05.25 PY-24.16



PY-25.23 PAC-243.14 PAM-34.11 PAM-34.15

**OPTION "D"**

- PB-07.11 Director (11.5cm)
- PC-17.14 Operating scissors . curved . sharp/blunt (14.5 cm)
- PC-59.15 RAGNELL (KILNER) Delicate dissecting scissors. curved (15cm)
- PC-59.15 FOX Gum scissors . curved (13cm)
- PE-06.17 Scalpel handle for blades figure 10-15 . no. 7 (12.5 cm)
- PF-21.12 ADSON BROWN Delicate forceps dressing/tissue.7 x 7 teeth (12cm)
- PF-34.32 SEMKEN Delicate forceps dressing/tissue (12.5 cm)
- PF-43.15 DEBAKEY "AT" Tissue Forceps . atraumatic serration (15cm)
- PF-60.26 Tissue forceps . bayonet (16cm)
- PF-70.13 TROELTSCH (WILDE) Tissue forceps (13cm)
- PG-19.20 GROSS Dressing forceps . straight
- PH-13.22 MICRO HALSTED Hemostatic forceps. curved (12.5 cm)
- PI-25.08 BACKHAUS Towel clamp (8.5cm)
- PJ-45.18 SENNING Needle holders . extra fine (17cm)
- PM-08.18 Mallet . with plastic facings , unscrewable . 200 g (18.5 cm)
- PT-23.04 LEMPERT Raspatory (17cm)
- PW-27.21 WALTER Curette . sharp . double ended (21 cm)
- PX-39.19 DEFOURMENTEL Bone rongeur (19cm)
- PY-05.25 COPE walter Nasal retractor . double ended (17.5 cm)
- PY-24.16 JOSEPH Delicate retractor . sharp . 1 tooth (16cm)
- PY-25.23 GUTHRIE Delicate retractor . sharp . 2 teeth (13 cm)
- PAC-243.14 WILLIGER WALTER Curette. sharp . double ended (14 cm)
- PAM-34.11 LUC BRUENINGS (HEYMANN) Nasal septum forceps (18cm)
- PAM-34.15 CRAIG Vomer forceps (17cm)



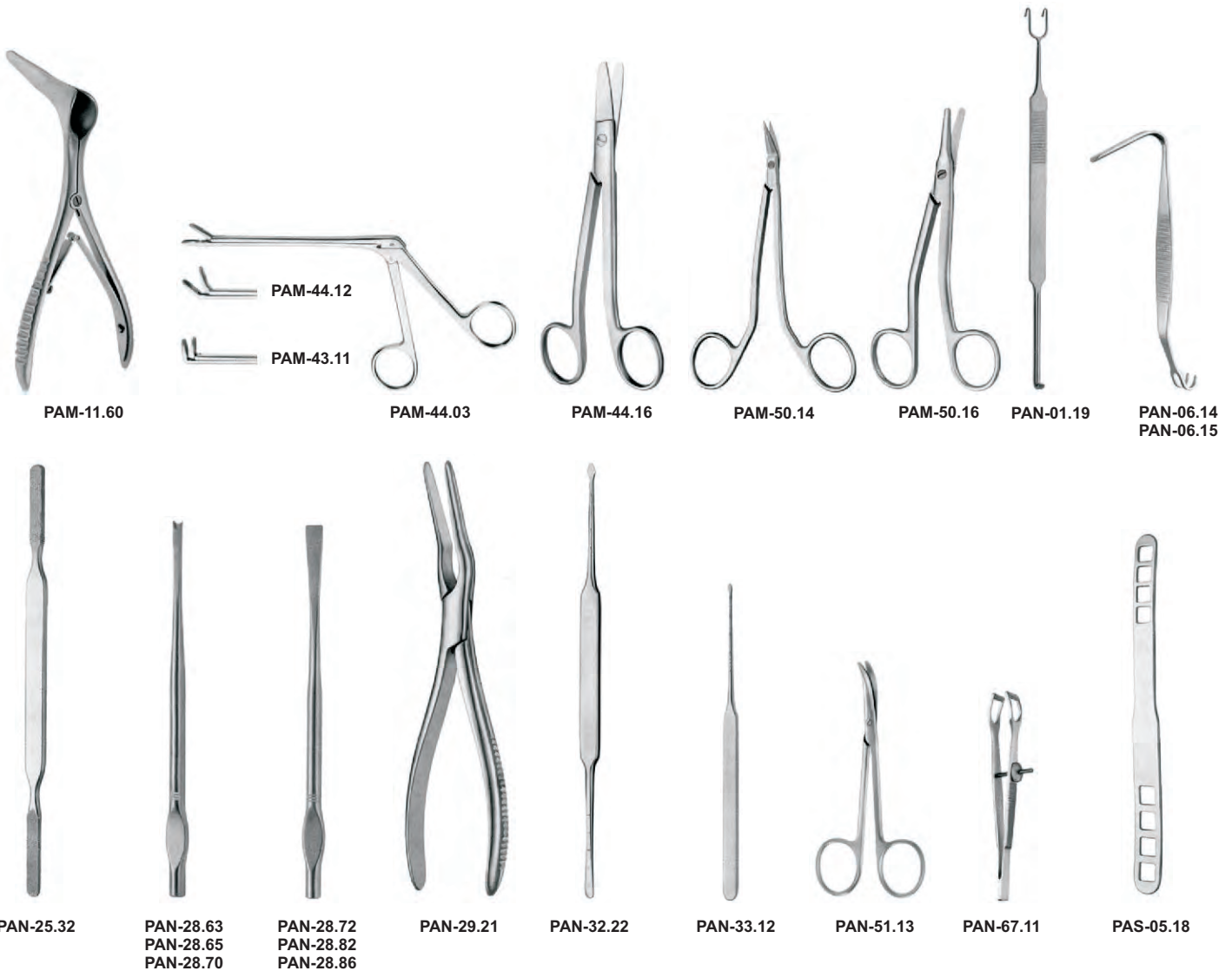

**OPTION "E"**

- PAM-11.60 COTTLE Nasal septum speculum (14 cm)
- PAM-43.11 MYLES Nasal forceps . straight (11 cm)
- PAM-44.03 WEIL BLAKESLEY Nasal forceps . straight . 4.2 mm (12 cm)
- PAM-44.12 WEIL BLAKESLEY Nasal forceps . angled upwards . 3.6 mm (12 cm)
- PAM-44.16 WALTER CASTANARES nasal scissors . facelift (16cm)
- PAM-50.14 WALTER Rhinoplasty scissors . supercut (14 cm)
- PAM-50.16 WALTER COTTLE Rhinoplasty scissors . supercut (16cm)
- PAN-01.19 NEIVERT Alar retractor . double ended . blunt (19.5 cm)
- PAN-06.14 AUFRICHT WALTER Nasal retractor . double ended . 42 x 7 mm (13.5 cm)
- PAN-06.15 AUFRICHT WALTER Nasal retractor . double ended . 38 x 7 mm (13.5 cm)
- PAN-25.32 FOMON Nasal rasp . double ended (22 cm)
- PAN-28.63 WALTER Chisel . 3 mm concave edge (19cm)
- PAN-28.65 WALTER Chisel . 5 mm concave edge (19cm)
- PAN-28.70 WALTER Osteotome . 12 mm concave cutting edge (19cm)
- PAN-28.72 WALTER Osteotome . 2 mm straight cutting edge (19cm)
- PAN-28.82 WALTER Osteotome . 12 mm straight cutting edge (19cm)
- PAN-28.86 WALTER Osteotome . curved . 6 mm straight cutting edge (19cm)
- PAN-29.21 ASCH Septum straightening forceps (22 cm)
- PAN-32.22 MASING Septum elevator . double ended (22 cm)
- PAN-33.12 COTTLE Septum elevator ( 16 cm)
- PAN-51.13 FOMON Rhinoplasty scissors . curved (12.5 cm)
- PAN-67.11 COTTLE Columella forceps (11 cm)
- PAS-05.48 BRUENINGS tongue spatula (19cm)

## Face and Forehead Lift

Lifting facial y frontal  
Lifting facial et frontal  
Lifting facciale e frontale



### OPTION "A"

- PB-68.03** Liposuction cannula- 0 3.0 mm.three holes,diagonal(20cm)
- PB-170.45** Handle for cannula- with hole-tube connection, rotatable (13 cm)
- PC-02.112** Iris scissors- supercut . curved (12.5 cm)
- PC-24.114** MAYO Dissecting scissors' supercut . straight (14 cm)
- PC-83.220** SOLZ Dissecting scissors "Gold Tip" . supercut . curved (20 cm) or
- PC-83.230** SOLZ Dissecting scissors "Gold Tip" . supercut- curved- (20 cm)
- PE-03.15** Scalpel blade- no.15 . packing unit 100 pieces- sterile
- PE-05.07** Scalpel handle- no.7 (16.5 cm)
- PF-19.12** MICRO-ADSON Delicate forceps dressing/tissue . 1 x 2 teeth (12 cm)
- PF-21.12** ADSON-BROWN Delicate forceps dressing/tissue- 7 x 7 teeth (12 cm)
- PF-34.70** SELECT Delicate forceps dressing/tissue- 1 x 2 teeth (20 cm)
- PI-25.08** BACKHAUS Towel clamp (8,5 cm)
- PJ-13.61** GUBISCH Needle holder' extra-fine (12.5 cm)
- PJ-33.15** BABY CRILE-WOOD Needle holder- fine
- PP-08.18** DEMARTEL Scalp flap forceps (14 cm)
- PY-12.19** GILLIES Delicate retractor . 1 tooth (19 cm)
- PY-21.05** JOSEPH Delicate retractor . 2 teeth (17 cm)
- PY-46.12** FARABEUF-BABY Retractor' double-ended' 10/12 mm- packing unit 2 pieces (12 cm)
- PY-51.39** WALTER Retractor' double-ended (19 cm)
- PY-77.13** LANGEN BECK-KOCHER Retractor' 15 x 80 mm
- PY-90.60** SOLZ Racket-Retractor' 45 x 100 mm (12.5 cm)
- PAN-64.30** PITANGUY Facelift marker (16 cm)

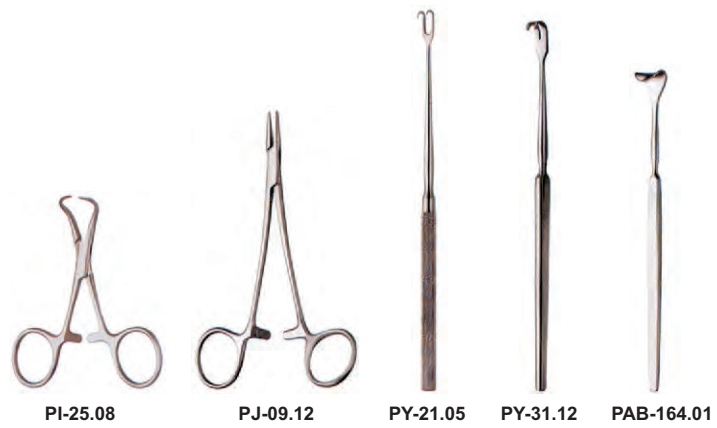

**OPTION "B"**

- PE-04.03** Scalpel handle for blades figure 10-15 no. 3 (12.5cm)
- PC-09.02** STEVENS Delicate scissors, straight, sharp (11.5cm)
- PC-09.03** STEVENS Delicate scissors, curved, sharp (11.5cm)
- PC-24.114** MAYO Dissecting scissors, supercut, straight (14cm)
- PH-10.12** HALSTED MOSQUITO Hemostatic forceps, straight (12.5cm)
- PH-11.12** HALSTED MOSQUITO Hemostatic forceps, curved, (12.5cm)
- PI-25.08** BACKHAUS Towel clamp (8.5cm)
- PJ-09.12** NEIVERT Needle holders, smooth (12.5cm)
- PY-12.19** GILLIES Delicate retractor, 1 tooth (19cm)
- PY-21.05** JOSEPH Delicate retractor, 2 teeth (17cm)
- PY-31.12** JOSEPH Delicate retractor, 2 teeth, blunt (16cm)
- PAB-164.01** DESMARRES Lid retractor, figure 1, 9 x 12 mm (13 cm)

## Ultra Fine Micro Surgical Instrument Set

Set ultra fine para microcirugía  
Jeu de microchirurgie ultra-fin  
Set ultra fino per la microchirurgia



PD-04.32



PD-04.34



PF-83.51



PF-111.14



PF-102.42



PH-18.52



PH-19.52



PJ-107.26



PJ-107.27



PJ-106.28



PJ-106.29

### PAZ-25.00 KOSHIMA Micro instruments set - complete

Consisting of :

- PD-04.32 KOSHIMA Micro scissors . curved . vannas-type cutting edges (15cm)
- PD-04.34 KOSHIMA Micro scissors . straight . vannas-type cutting edges (15cm)
- PF-83.51 KOSHIMA Micro forceps (11 cm)
- PF-111.14 MICRO 2000 (KOSHIMAZ) micro forceps (14cm)
- PF-102.42 JACOBSON ADSON (KOSHIMA) Micro needle holder, straight . with catch (14.5 cm)
- PH-18.52 MICRO JACOBSON (KOSHIMA) Hemostatic forceps, straight (12.5cm)
- PH-19.52 MICRO JACOBSON (KOSHIMA) Hemostatic forceps, curved (12.5cm).
- PJ-107.26 CASTROVIEJO (KOSHIMA) Micro needle holder, curved . with catch (14.5 cm)
- PJ-107.27 CASTROVIEJO (KOSHIMA) Micro needle holder, curved, with catch (14.5cm)
- PJ-106.28 CASTROVIEJO (KOSHIMA) Micro needle holder, straight, (14.5cm)
- PJ-106.29 CASTROVIEJO (KOSHIMA) Micro needle holder, curved, (14.5cm)

**Extraction of Bone Chips from Ribs**  
 Extracción de viruta ósea de las costillas  
 Prélèvement de cartilage des côtes  
 Prelevamento di truciolo costabile

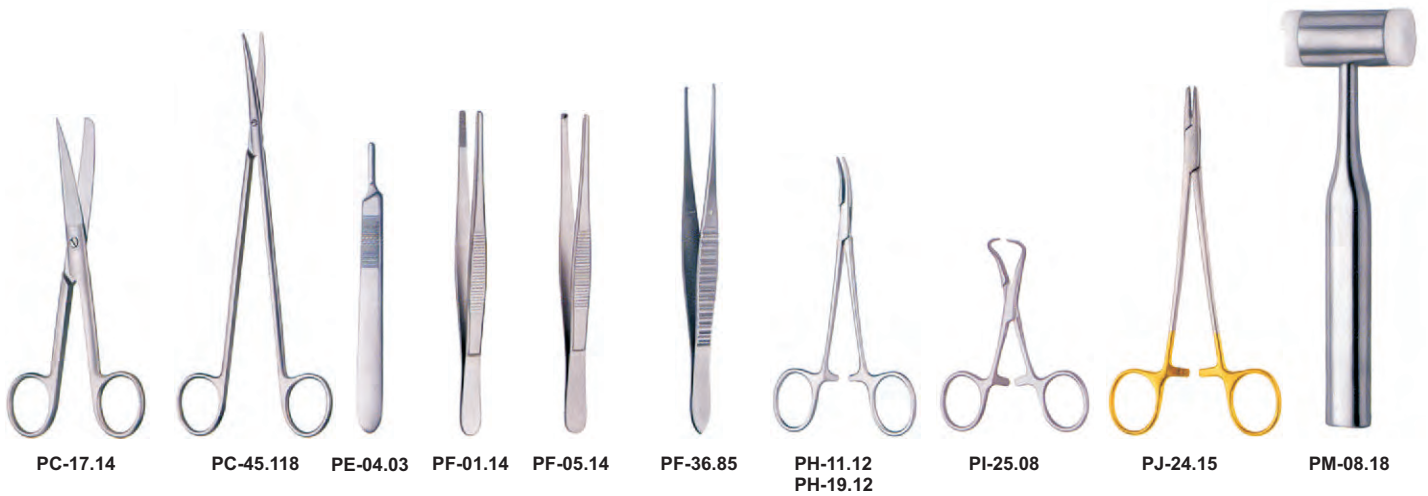

PC-17.14 PC-45.118 PE-04.03 PF-01.14 PF-05.14 PF-36.85 PH-11.12 PH-19.12 PI-25.08 PJ-24.15 PM-08.18



PU-38.19 PU-51.21 PV-12.12 PV-12.20 PV-60.20 PV-36.80 PV-36.85 PX-31.18 PY-54.04 PZ-30.13 PZ-30.16

- PC-17.14 Operating scissors, curved, sharp/blunt (14.5cm)
- PC-45.118 METZENBAUM slim Dissecting scissors, curved, (18cm)
- PE-04.03 Scalpel handle fo rblades figure 10-15 no. 3 (12.5cm)
- PF-01.14 Dressing forceps (14.5cm)
- PF-05.14 Tissue Forceps , 1x2 teeth (14.5cm)
- PF-36.85 GILLIES Tissue forceps , 1x2 teeth (15cm)
- PH-11.12 HALSTED MOSQUITO Hemostatic forceps, curved (12.5cm)
- PH-19.12 HALSTED MOSQUITO hemostatic forceps, cuded, 1 x 2 teeth (12.5cm)
- PI-25.08 BACKHAUS Towel clamp (8.5cm)
- PJ-24.15 MAYO HEGAR TC needle holder, fine (15cm)
- PM-08.18 Mallet , with plastic facings, unscrewable , 200 g (18.5 cm)
- PU-38.19 DIGNMAN Bone holding forceps (19 cm)
- PU-51.21 LANGENBECK Bone holding forceps (20 cm)
- PV-12.12 STILLE Osteotome , 12 mm (20 cm)
- PV-12.20 STILLE Osteotome, 20 mm (20 cm)
- PV-60.20 LEXER Gouge , 20 mm (22 cm)
- PV-36.80 LEXER Gouge, 10 mm (25 cm)
- PV-36.85 LEXER Gouge, 15 mm (25 cm)
- PX-31.18 BEYER Bone rongeur (18 cm)
- PY-54.04 VOLKMANN Retractor, 4 teeth , 18mm, sharp (20 cm)
- PZ-30.13 VOLKMANN Retractor, 4 teeth , 18mm, sharp (20 cm)
- PZ-30.16 WEITLANER Self-retaining retractor, blunt (16.5 cm)
- PAG-14.25 GIERTZ Rib shears (25 cm)
- PAG-46.11 DOYEN Rip raspatory , right (17cm)
- PAG-46.12 DOYEN Rip raspatory, left (17cm)
- PAN-36.63 OBWEGESER Raspatory , 9 mm (18cm)



PAG-14.25 PAG-46.11 PAG-46.12 PAN-36.63



**Mammoplasty**  
 Mamoplastia  
 Plastie mammaire  
 Plastica mammaria



PAF-06.06

- PC-39.20** METZENBAUM Dissecting scissors, curved (20cm)
- PC-64.14** JABALEY Delicate scissors, standard , curved (13cm)
- PC-64.114** JABALEY Delicate scissors, supercut, curved (13 cm)
- PC-83.220** SOLZ Dissecting scissors "Gold Tip" , supercut, curved (20 cm)
- PC-83.230** SOLZ Dissecting scissors "Gold Tip", supercut, curved, (20 cm)
- PE-03.15** Scalpel blade, no 15, packing unit 100 pieces, sterile
- PE-05.07** Scalpel handle, no. 7 (16.5 cm)
- PF-19.12** MICRO ADSON Delicate forceps dressing/ tissue, 1x2 teeth (12 cm)
- PF-65.19** GRUENWALD Bayonet forcps (19.5cm)
- PJ-32.15** BABY CRILE WOOD Needle holder, fine (15 cm)
- PJ-33.15** BABY CRILE WOOD TC Needle holder, fine ( 15cm)
- PY-46.12** FARABEUFBABY Retractor, double-ended , 10/12 mm , packing unit 2 pieces (12 cm)
- PY-77.13** LANGENBECK KOCHER Retractor, 15 x 80 mm (21 cm)
- PY-90.10** SOLZ Non-traumatical breast dissector (34 cm)
- PY-90.11** SOLZ Non-traumatical breast dissector (37 cm)
- PY-90.15** SOLZ Hook dissector (36 cm)
- PY-90.20** SOLZ Areola marker, blunt(Ø = 36 mm)
- PY-90.25** SOLZ Areola marker, blunt(Ø = 40 mm)
- PY-90.30** SOLZ Areola marker, blunt(Ø = 42 mm)
- PY-90.35** SOLZ Areola marker, blunt(Ø = 45 mm)
- PY-90.40** MARX Breast retractor, 125 x 30 mm (27 cm)
- PY-90.45** MARX Breast retractor, 140 x 30 mm (27 cm)
- PAF-06.06** Bowl for marking colour, 0.06 | (Ø = 6 cm)



## Preparation of Full Thickness Skin Graft

Preparació de injertos de piel entera

Préparation des greffes de peau entière

Préparation des greffes de peau entière



PC-37.164

PF-03.14

PF-07.14

PH-13.12

PJ-24.20

PJ-27.68

PY-25.23

- PC-37.164** METZENBAUM Dissecting scissors, supercut plus, curved (18cm)  
**PF-03.14** Delicate forceps dressing/ tissue (14.5 cm)  
**PF-07.14** Delicate forceps dressing/ tissue, 1 x 2 teeth (14.5 cm)  
**PH-13.12** HALSTED MOSQUITO Hemostatic forceps, curved (14 cm)  
**PJ-24.20** MAYO HEGAR "TC" Needle holder, normal (20 cm)  
**PJ-27.68** MICRO SLIM "TC" Needle holder, fine (18cm)  
**PY-25.23** GUTHRIE Delicate retractor, 2 teeth , sharp (13 cm)

## Harvesting of Costal Cartilages

Toma de cartilago de costilla

Prélèvement de cartilages des côtes

prelievo di cartilagine costabile



PC-25.114

PF-35.15

PF-36.85

PT-18.24

PY-02.16

PY-24.16

PY-71.10  
PY-71.13

PY-76.32

PAM-30.50

PAN-37.18

PAP-40.17

- PC-25.114** MAYO Delicate scissors, supercut, curved (14cm)  
**PF-35.15** McINDOE Delicate forceps dressing / tissue (15 cm)  
**PF-36.85** GILLIES Delicate forceps dressing/ tissue, 1x2 teeth (15cm)  
**PT-18.24** COHEN Elevator, double-ended, 5 mm (24 cm)  
**PY-02.16** SENN-MILLER Delicate retractor, double-ended, blunt (16cm)  
**PY-24.16** JOSEPH Delicate retractor (16cm)  
**PY-71.10** LANGENBECK Retractor, 10 x 40 mm (21 cm)  
**PY-71.13** LANGENBECK Retractor, 13 x 42 mm (21 cm)  
**PY-76.32** KOCHER Retractor, 12 x 60 mm (21 cm)  
**PAM-30.50** PENNINGTON Septum elevator, double-ended (20cm)  
**PAN-37.18** DINGMANN Rasptory, double-ended (18cm)  
**PAP-40.17** JACKSON Delicate retractor, double-ended, blunt (18cm)

**Auricular Reconstruction with Costal Cartilages**  
 Reconstrució auricular con cartilago de costilla  
 Reconstruciton auriculaire avec cartilages des côtes  
 Ricostruzione auricolare con cartilagine costale



PE-22.01



PE-22.02



PE-22.04



PE-22.05



PE-22.06



PF-15.12



PF-16.12



PF-35.15



PF-41.25



PH-11.12



PJ-08.61  
PJ-08.63



PJ-69.17



PS-24.12



PT-11.26



PT-11.27



PU-04.65



PU-75.40



PAB-196.142



PAB-196.143



PAG-46.11



PAG-46.12

- PE-22.01 NAGATA Sculptur knife handle , small (12 cm)
- PE-22.02 NAGATA Sculptur knife handle , large (12 cm)
- PE-22.04 NAGATA Sculptur knife blade, 3.0mm (8 cm)
- PE-22.05 NAGATA Sculptur knife blade, 4.5mm (8 cm)
- PE-22.06 NAGATA Sculptur knife blade, 6.0mm (8.5 cm)
- PF-15.12 ADSON Delicate forceps dressing/ tissue, serrated (12 cm)
- PF-16.12 ADSON Delicate forceps dressing/ tissue, 1 x 2 teeth (12 cm)
- PF-35.15 McINDOE Delicate forceps dressing/ tissue, serrated (15 cm)
- PF-41.25 GILLIES Delicate forcps dressing/ tissue , 1 x 2 teeth (15 cm)
- PH-11.12 HALSTED MOSQUITO Hemostatic forceps, curved (12.5cm)
- PJ-08.61 NAGATA "TC" Needle holder, smooth (11.5cm)
- PJ-08.63 NAGATA "TC" Needle holder, smooth (13cm)
- PJ-69.17 MATHIEU "TC" Needle holder, regular (17cm)
- PS-24.12 UNIVERSAL "TC" Wire cutting scissors, serrated cutting edge (12cm)
- PT-11.26 NAGATA Septum elevator, blunt, double-ended (16cm)
- PT-11.27 NAGATA Septum elevator, blunt, double-ended (17cm)
- PU-04.65 NIRO "TC" Wire twisting forceps (15cm)
- PU-75.40 NIRO "TC" Wire twisting forceps (15cm)
- PAB-196.142 Delicate dissecting scissors, supercut, straight (12cm)
- PAB-196.143 Delicate dissecting scissors, supercut, curved (12cm)
- PAG-46.11 DOYEN Rip raspatory , right (17cm)
- PAG-46.12 DOYEN Rip raspatory , left (17cm)

**Auricular Reconstruction with Costal Cartilages**  
 Reconstruició auricular con cartilago de costilla  
 Reconstructio auriculaire avec cartilages des côtes  
 Ricostruzione auricolare con cartilagine costale



PC-10.113

PC-24.114

PC-59.13

PC-77.133

PC-80.123

PC-83.220

PC-82.230



PE-01.15

PE-02.21

PE-05.07

PE-10.64

PF-16.15

PF-21.13

PF-41.20

PF-41.25

PI-25.08

PJ-13.62

PJ-24.15

PJ-24.23

PY-21.10

PY-46.12

- PC-10.113 STEVENS Delicate scissors (iris), supercut, curved (11.5cm)
- PC-24.114 MAYO Dissecting scissors, supercut , straight (14cm)
- PC-59.13 RAGNELL (KILNER) Delicate Dissecting scissors, curved (13 cm)
- PC-77.133 GORNEY Dissecting scissors, supercut, curved (23 cm)
- PC-80.123 GORNEY FREEMAN Dissecting scissors, supercut, curved (23 cm)
- optional
- PC-83.220 SOLZ Dissecting scissors "Gold Tip" , supercut, curved (20cm)
- PC-83.230 SOLZ Dissecting scissors "Gold Tip" , supercut, curved (20 cm)
- PE-01.15 Scalpel blade, no .15 , packing unit 100 pieces, sterile
- PE-02.21 Scalpel blade, no.21 , packing unit 100 pieces, sterile
- PE-05.07 Scalpel handle, no.7 (16.5 cm)
- PE-10.64 Scalpel handle, no.4L (21cm)
- PF-16.15 ADSON Delicate forceps dressing/ tissue , 1 x 2 teeth (15cm)
- PF-21.13 ADSON BROWN Delicate forceps dressing/ tissue , 9x9 teeth (12 cm)
- PF-41.20 POTTS SMITH Forceps dressing/ tissue , 1 x 2 teeth (21 cm)
- PF-41.25 ADSON Delicate forceps dressing/ tissue , 1 x 2 teeth (25 cm)
- PI-25.08 BACKHAUS Towel clamp (8,5cm)
- PJ-13.62 WRIGHT (DERF) "TC" Needle holde, fine (12.5cm)
- PJ-24.15 MAYO HEGAR "TC" Needle holder, fine (15 cm)
- PJ-24.23 MAYO HEGAR "TC" Needle holder, fine (23 cm)
- PY-21.10 JOSEPH Delicate retractor, 2 teeth , 10 mm , sharp (17cm)
- PY-46.12 FARABEUF BABY Retractor, double-ended, 10/12 mm, packing unit 2 pieces (12 cm)
- PY-74.06 ISRAEL Retractor, 60 x 50 mm , blunt , 6 teeth ( 25 cm)
- PY-90.50 SALDANHA SOLZ Abdominal retractor (37cm)
- PY-90.53 SOLZ Navel marker, dismantable (29 cm)



PY-74.06

PY-90.50

PY-90.53

**NUMERICAL INDEX**

---



Item No.	Page No.	Item No.	Page No.	Item No.	Page No.
PA-37.15	002	PC-12.132	008	PC-37.114	011
PA-37.20	002	PC-12.32	008	PC-37.115	011
PA-37.30	002	PC-12.52	008	PC-37.14	011
PA-37.50	002	PC-12.62	007	PC-37.15	011
PA-38.10	002	PC-12.70	008	PC-37.161	010
PA-38.30	002	PC-12.90	008	PC-37.164	011
PA-38.40	002	PC-13.60	007	PC-37.61	010
PA-38.41	002	PC-13.61	007	PC-37.64	011
PA-38.44	003	PC-13.62	007	PC-38.118	011
PA-39.01	003	PC-13.63	008	PC-38.120	011
PA-39.02	003	PC-24.114	009	PC-38.168	011
PC-01.09	006	PC-24.117	009	PC-38.170	011
PC-01.10	006	PC-24.14	009	PC-38.18	011
PC-01.11	006	PC-24.164	009	PC-38.20	011
PC-01.110	006	PC-24.167	009	PC-38.68	011
PC-01.111	006	PC-24.17	009	PC-38.70	011
PC-01.12	006	PC-24.64	009	PC-39.118	011
PC-01.171	006	PC-24.67	009	PC-39.120	011
PC-02.09	006	PC-25.114	009	PC-39.168	011
PC-02.10	006	PC-25.117	009	PC-39.170	011
PC-02.11	006	PC-25.14	009	PC-39.18	011
PC-02.110	006	PC-25.164	009	PC-39.20	011
PC-02.111	006	PC-25.167	009	PC-39.68	011
PC-02.112	006	PC-25.17	009	PC-39.70	011
PC-02.12	006	PC-25.64	009	PC-40.123	012
PC-02.171	006	PC-25.67	009	PC-40.126	012
PC-03.30	006	PC-30.115	009	PC-40.130	012
PC-04.130	006	PC-30.117	009	PC-40.173	012
PC-04.30	006	PC-30.15	009	PC-40.23	012
PC-05.161	006	PC-30.17	009	PC-40.26	012
PC-05.171	006	PC-31.165	009	PC-40.30	012
PC-05.61	006	PC-31.167	009	PC-40.73	012
PC-05.71	006	PC-31.65	009	PC-41.123	013
PC-06.161	006	PC-31.67	009	PC-41.126	013
PC-06.171	006	PC-32.116	010	PC-41.130	013
PC-06.61	006	PC-32.117	010	PC-41.173	013
PC-06.71	006	PC-32.17	010	PC-41.176	013
PC-09.70	007	PC-32.187	010	PC-41.180	013
PC-09.71	007	PC-32.197	010	PC-41.23	013
PC-10.112	007	PC-32.86	010	PC-41.26	013
PC-10.113	007	PC-32.97	010	PC-41.30	013
PC-10.115	007	PC-34.196	010	PC-41.73	013
PC-10.12	007	PC-34.96	010	PC-41.76	013
PC-10.13	007	PC-35.196	010	PC-41.80	013
PC-10.15	007	PC-35.96	010	PC-42.114	013
PC-10.70	007	PC-36.109	012	PC-42.14	013
PC-10.71	007	PC-36.11	010	PC-42.164	013
PC-11.10	007	PC-36.111	010	PC-42.64	013
PC-11.112	007	PC-36.114	011	PC-43.114	014
PC-11.12	007	PC-36.14	011	PC-43.14	014
PC-11.132	008	PC-36.164	011	PC-43.164	014
PC-11.32	008	PC-36.61	010	PC-43.64	014
PC-11.52	008	PC-36.64	011	PC-44.118	013
PC-11.70	008	PC-36.161	010	PC-44.120	013
PC-12.10	007	PC-37.109	012	PC-44.123	013
PC-12.112	007	PC-37.11	010	PC-44.168	013
PC-12.12	007	PC-37.111	010	PC-44.170	013

## Numerical Index

Item No.	Page No.	Item No.	Page No.	Item No.	Page No.
PC-44.173	013	PC-59.165	016	PC-77.67	020
PC-44.18	013	PC-59.168	016	PC-77.69	020
PC-44.20	013	PC-59.18	016	PC-77.73	020
PC-44.23	013	PC-59.20	016	PC-80.01	021
PC-44.68	013	PC-59.63	016	PC-80.117	020
PC-44.70	013	PC-59.65	016	PC-80.119	020
PC-44.73	013	PC-59.68	016	PC-80.123	020
PC-45.118	014	PC-60.122	017	PC-80.152	021
PC-45.120	014	PC-61.122	017	PC-80.37	020
PC-45.123	014	PC-64.11	017	PC-80.39	020
PC-45.168	014	PC-64.111	017	PC-80.43	020
PC-45.170	014	PC-64.112	017	PC-80.72	021
PC-45.173	014	PC-64.113	017	PC-81.115	021
PC-45.176	014	PC-64.114	017	PC-81.117	021
PC-45.178	014	PC-64.12	017	PC-81.119	022
PC-45.18	014	PC-64.13	017	PC-81.123	022
PC-45.20	014	PC-64.14	017	PC-81.132	022
PC-45.23	014	PC-65.114	017	PC-81.37	021
PC-45.68	014	PC-65.134	018	PC-81.39	022
PC-45.70	014	PC-65.14	017	PC-81.43	022
PC-45.73	014	PC-65.144	018	PC-83.220	022
PC-46.116	016	PC-66.114	017	PC-83.230	022
PC-46.16	016	PC-66.134	018	PC-90.113	023
PC-46.166	016	PC-66.14	017	PC-90.13	023
PC-46.168	015	PC-66.144	018	PC-90.163	023
PC-46.170	015	PC-67.114	018	PC-90.63	023
PC-46.173	015	PC-67.14	018	PC-91.113	023
PC-46.178	015	PC-67.164	018	PC-91.13	023
PC-46.180	015	PC-67.18	018	PC-91.163	023
PC-46.183	015	PC-67.20	018	PC-91.63	023
PC-46.66	016	PC-67.64	018	PD-01.20	030
PC-46.78	015	PC-68.114	018	PD-01.21	030
PC-46.80	015	PC-68.118	018	PD-01.120	030
PC-46.83	015	PC-68.14	018	PD-01.121	030
PC-47.116	016	PC-68.164	018	PD-01.22	030
PC-47.16	016	PC-68.18	018	PD-01.23	030
PC-47.166	016	PC-68.20	018	PD-01.30	030
PC-47.168	015	PC-68.64	018	PD-01.31	030
PC-47.170	015	PC-69.117	019	PD-01.74	030
PC-47.173	016	PC-70.118	019	PD-01.75	030
PC-47.66	015	PC-72.12	019	PD-01.76	030
PC-48.116	015	PC-72.14	019	PD-01.77	030
PC-49.116	015	PC-72.16	019	PD-07.20	030
PC-50.118	014	PC-72.18	019	PD-07.21	030
PC-50.168	014	PC-73.112	019	PD-07.25	030
PC-50.18	014	PC-73.116	019	PD-07.26	030
PC-50.68	014	PC-73.118	019	PD-08.02	030
PC-58.131	016	PC-73.14	019	PE-03.10	032
PC-58.132	016	PC-73.16	019	PE-03.11	032
PC-58.61	016	PC-73.18	019	PE-03.12	032
PC-58.62	016	PC-74.116	020	PE-03.15	032
PC-59.113	016	PC-74.120	020	PE-03.21	032
PC-59.115	016	PC-74.126	020	PE-03.23	032
PC-59.118	016	PC-74.130	020	PE-03.32	032
PC-59.13	016	PC-77.127	020	PE-03.35	032
PC-59.15	016	PC-77.129	020	PE-04.03	032
PC-59.163	016	PC-77.133	020	PE-05.07	032



Item No.	Page No.	Item No.	Page No.	Item No.	Page No.
PE-06.17	032	PF-37.15	041	PJ-05.13	050
PE-07.13	032	PF-37.20	041	PJ-06.15	050
PE-08.23	032	PF-38.15	041	PJ-07.65	050
PE-10.40	032	PF-38.20	041	PJ-08.61	050
PE-10.45	033	PF-42.40	041	PJ-08.63	050
PE-10.53	033	PF-43.15	041	PJ-09.12	050
PE-10.61	033	PF-60.15	041	PJ-10.62	050
PE-10.63	033	PF-60.23	041	PJ-12.12	051
PE-10.64	033	PF-60.26	041	PJ-13.61	051
PE-10.86	034	PF-60.36	041	PJ-13.62	051
PE-10.87	034	PF-64.16	042	PJ-14.13	051
PE-10.90	034	PF-70.13	042	PJ-15.63	051
PE-10.92	034	PF-71.50	042	PJ-17.82	051
PE-10.94	034	PF-71.51	042	PJ-21.18	052
PE-10.95	034	PF-71.52	042	PJ-21.20	052
PE-10.97	034	PF-71.53	042	PJ-21.23	052
PE-22.02	035	PF-71.60	042	PJ-22.15	052
PE-22.04	035	PF-71.61	042	PJ-22.18	052
PE-22.05	035	PF-71.62	042	PJ-22.20	052
PE-22.06	035	PF-71.63	042	PJ-22.23	052
PE-30.30	036	PF-71.70	042	PJ-22.25	052
PE-30.31	036	PF-71.71	042	PJ-22.30	052
PE-30.32	036	PF-71.72	042	PJ-23.15	053
PE-30.50	036	PF-71.73	042	PJ-23.18	053
PE-30.51	036	PF-71.84	042	PJ-23.20	053
PE-30.52	036	PH-04.08	046	PJ-23.23	053
PE-30.60	036	PH-04.12	046	PJ-23.24	053
PF-07.14	038	PH-04.16	046	PJ-24.15	053
PF-15.12	038	PH-04.28	046	PJ-24.18	053
PF-15.62	038	PH-04.32	046	PJ-24.20	053
PF-15.65	038	PH-04.36	046	PJ-24.23	053
PF-16.01	038	PH-10.12	046	PJ-24.24	053
PF-16.05	038	PH-10.22	046	PJ-24.26	053
PF-16.12	039	PH-11.12	046	PJ-24.30	053
PF-16.13	039	PH-13.22	046	PJ-34.15	052
PF-16.15	039	PH-14.42	047	PJ-45.15	054
PF-16.62	042	PH-15.42	047	PJ-45.16	054
PF-16.65	042	PH-18.12	046	PJ-45.17	054
PF-17.12	042	PH-18.22	046	PJ-45.18	054
PF-18.15	039	PH-18.42	047	PJ-46.17	054
PF-19.12	039	PH-18.52	047	PJ-47.20	054
PF-20.15	039	PH-18.60	047	PJ-48.20	054
PF-21.12	039	PH-18.62	047	PJ-48.24	054
PF-21.13	039	PH-19.12	047	PJ-48.26	054
PF-22.72	040	PH-19.22	047	PJ-48.30	054
PF-23.82	040	PH-19.42	047	PJ-53.14	055
PF-30.12	040	PH-19.52	047	PJ-54.15	055
PF-30.15	040	PH-19.60	047	PJ-55.15	055
PF-31.22	040	PH-19.62	047	PJ-55.31	055
PF-31.25	040	PH-30.14	048	PJ-55.34	055
PF-32.12	040	PH-31.14	048	PJ-55.37	055
PF-32.15	040	PH-32.14	048	PJ-55.58	055
PF-33.22	040	PH-33.14	048	PJ-56.16	056
PF-33.25	040	PH-34.15	048	PJ-69.14	056
PF-34.32	040	PH-35.15	048	PJ-69.17	056
PF-35.15	040	PH-36.15	048	PJ-69.20	056
PF-36.85	041	PH-37.15	048	PJ-69.24	056

## Numerical Index

Item No.	Page No.	Item No.	Page No.	Item No.	Page No.
PK-21.15	057	PT-18.01	061	PY-24.36	069
PK-21.18	057	PT-18.02	062	PY-24.42	069
PK-21.21	057	PT-18.03	062	PY-24.50	069
PK-21.38	057	PT-18.24	062	PY-24.51	069
PK-21.41	057	PT-18.38	062	PY-25.13	069
PK-22.13	057	PT-23.02	062	PY-25.15	069
PK-22.15	057	PT-23.03	062	PY-25.23	069
PK-22.18	057	PT-23.04	062	PY-29.01	070
PK-22.21	057	PT-23.05	062	PY-29.02	070
PK-22.38	057	PT-23.06	062	PY-29.03	070
PK-22.41	057	PT-38.18	063	PY-29.04	070
PK-31.15	057	PT-38.19	063	PY-30.01	070
PK-31.18	057	PT-38.28	063	PY-30.02	070
PK-31.21	057	PT-38.29	063	PY-30.03	070
PK-31.41	057	PT-46.08	063	PY-30.04	070
PK-32.13	057	PT-46.10	063	PY-31.15	070
PK-32.15	057	PU-04.50	064	PY-32.62	070
PK-32.18	057	PU-04.65	064	PY-32.63	070
PK-32.21	057	PU-04.76	064	PY-33.01	071
PK-32.41	057	PU-48.43	064	PY-33.02	071
PK-33.15	057	PU-50.56	064	PY-33.03	071
PK-33.18	057	PU-74.20	064	PY-33.04	071
PK-33.21	057	PU-75.40	064	PY-33.05	071
PK-33.38	057	PY-01.16	066	PY-33.06	071
PK-33.41	057	PY-02.16	066	PY-33.62	070
PK-34.13	057	PY-05.16	066	PY-33.63	070
PK-34.15	057	PY-05.18	066	PY-46.12	071
PK-34.18	057	PY-05.25	066	PY-47.15	071
PK-34.21	057	PY-07.50	066	PY-51.39	071
PK-34.38	057	PY-07.52	066	PY-71.10	072
PK-34.41	057	PY-07.58	066	PY-71.12	072
PM-08.18	060	PY-07.65	067	PY-71.13	072
PM-08.40	060	PY-07.66	067	PY-71.16	072
PM-08.75	060	PY-07.75	067	PY-76.31	072
PM-14.35	060	PY-07.85	067	PY-76.32	072
PM-14.45	060	PY-08.20	067	PY-90.00	073
PM-14.50	060	PY-09.20	067	PY-90.10	074
PS-19.09	023	PY-10.20	067	PY-90.11	074
PS-20.10	023	PY-11.12	067	PY-90.15	074
PS-20.12	023	PY-12.19	067	PY-90.20	073
PS-20.60	023	PY-12.20	067	PY-90.25	073
PS-20.62	023	PY-20.13	068	PY-90.30	073
PS-21.13	023	PY-21.02	068	PY-90.35	073
PS-21.35	023	PY-21.05	068	PY-90.40	075
PS-22.09	024	PY-21.07	068	PY-90.45	075
PS-24.12	024	PY-21.10	068	PY-90.50	076
PS-36.84	024	PY-23.03	068	PY-90.53	077
PS-36.88	024	PY-23.05	068	PY-100.01	078
PS-36.93	024	PY-23.07	068	PY-100.02	078
PT-11.26	061	PY-23.15	068	PY-100.03	078
PT-11.27	061	PY-23.16	068	PY-100.04	078
PT-13.04	061	PY-24.14	068	PY-100.05	078
PT-15.03	061	PY-24.15	068	PZ-14.01	079
PT-15.05	061	PY-24.16	069	PZ-14.02	079
PT-15.07	061	PY-24.21	069	PZ-15.03	079
PT-17.04	061	PY-24.24	069	PZ-15.04	079
PT-17.05	061	PY-24.26	069	PZ-16.52	079

Item No.	Page No.	Item No.	Page No.	Item No.	Page No.
PZ-17.05	079	PAM-11.62	089	PAM-45.12	092
PZ-17.06	079	PAM-14.14	089	PAM-45.13	092
PZ-18.07	079	PAM-14.15	089	PAM-45.14	092
PZ-18.08	079	PAM-14.16	089	PAM-45.15	092
PZ-19.07	079	PAM-14.17	089	PAM-50.113	026
PZ-19.08	079	PAM-14.59	089	PAM-50.13	026
PZ-23.09	079	PAM-16.15	089	PAM-50.14	026
PZ-23.10	079	PAM-16.16	089	PAM-50.16	026
PZ-24.07	079	PAM-16.17	089	PAM-50.163	026
PZ-24.08	079	PAM-17.122	025	PAM-50.177	026
PZ-25.10	079	PAM-17.17	025	PAM-50.77	026
PZ-25.11	079	PAM-17.20	025	PAM-51.116	026
PZ-26.13	080	PAM-17.21	025	PAM-51.136	026
PZ-27.10	080	PAM-20.16	090	PAM-51.16	026
PZ-28.11	080	PAM-24.16	090	PAM-51.36	026
PZ-28.12	080	PAM-24.17	090	PAM-51.63	027
PZ-29.13	080	PAM-25.16	090	PAN-01.17	094
PZ-29.16	080	PAM-25.17	090	PAN-01.19	094
PZ-30.13	080	PAM-25.46	090	PAN-01.20	094
PZ-30.14	080	PAM-25.47	090	PAN-01.21	094
PZ-30.16	080	PAM-30.50	090	PAN-01.23	094
PZ-30.17	080	PAM-34.11	091	PAN-01.44	094
PAB-164.00	081	PAM-34.12	091	PAN-02.14	094
PAB-164.01	081	PAM-34.15	091	PAN-03.14	094
PAB-164.02	081	PAM-34.16	091	PAN-04.10	095
PAB-164.03	081	PAM-34.17	091	PAN-04.14	094
PAB-164.04	081	PAM-34.75	091	PAN-04.15	095
PAB-196.142	008	PAM-44.01	092	PAN-04.37	095
PAB-196.143	008	PAM-44.02	092	PAN-05.14	095
PAB-196.42	008	PAM-44.03	092	PAN-05.16	095
PAB-196.43	008	PAM-44.04	092	PAN-06.14	095
PAB-57.18	043	PAM-44.05	092	PAN-06.15	095
PAB-82.32	003	PAM-44.11	092	PAN-06.17	095
PAB-82.41	003	PAM-44.12	092	PAN-06.30	096
PAB-82.42	003	PAM-44.13	092	PAN-09.12	096
PAB-82.43	003	PAM-44.14	092	PAN-10.17	096
PAC-243.14	062	PAM-44.15	092	PAN-10.19	096
PAF-06.06	073	PAM-44.26	093	PAN-11.08	097
PAG-46.11	086	PAM-44.27	093	PAN-12.15	097
PAG-46.12	086	PAM-44.28	093	PAN-13.14	097
PAK-25.117	025	PAM-44.35	093	PAN-13.16	097
PAK-25.17	025	PAM-44.36	093	PAN-14.15	097
PAM-04.16	087	PAM-44.37	093	PAN-15.14	097
PAM-05.20	087	PAM-44.59	093	PAN-17.26	097
PAM-06.20	087	PAM-44.60	093	PAN-17.27	097
PAM-06.21	087	PAM-44.61	093	PAN-18.24	098
PAM-06.30	088	PAM-44.71	092	PAN-19.24	098
PAM-08.15	088	PAM-44.72	092	PAN-20.24	098
PAM-08.16	088	PAM-44.73	092	PAN-21.24	098
PAM-08.17	088	PAM-44.74	092	PAN-21.25	098
PAM-09.10	088	PAM-44.75	092	PAN-22.25	098
PAM-09.11	088	PAM-44.81	092	PAN-23.47	098
PAM-11.50	088	PAM-44.82	092	PAN-23.50	098
PAM-11.51	088	PAM-44.83	092	PAN-24.10	099
PAM-11.52	088	PAM-44.84	092	PAN-24.26	099
PAM-11.53	088	PAM-44.85	092	PAN-24.35	099
PAM-11.60	088	PAM-45.11	092	PAN-24.36	099

## Numerical Index

Item No.	Page No.	Item No.	Page No.	Item No.	Page No.
PAN-24.45	099	PAN-28.75	104	PAN-36.31	112
PAN-24.46	099	PAN-28.77	104	PAN-36.32	112
PAN-25.00	099	PAN-28.79	104	PAN-36.33	112
PAN-25.01	099	PAN-28.80	104	PAN-36.34	112
PAN-25.03	099	PAN-28.82	104	PAN-36.35	113
PAN-25.26	100	PAN-28.85	104	PAN-36.36	113
PAN-25.27	100	PAN-28.86	104	PAN-36.37	113
PAN-25.28	100	PAN-29.21	105	PAN-36.38	113
PAN-25.32	100	PAN-29.23	106	PAN-36.39	113
PAN-25.41	100	PAN-29.35	107	PAN-36.40	113
PAN-25.42	100	PAN-29.36	107	PAN-36.41	113
PAN-25.43	100	PAN-30.12	002	PAN-36.42	113
PAN-25.44	100	PAN-30.14	002	PAN-36.43	113
PAN-25.45	100	PAN-30.21	104	PAN-36.50	114
PAN-25.46	100	PAN-30.22	104	PAN-36.51	114
PAN-27.55	100	PAN-30.23	104	PAN-36.52	114
PAN-27.62	100	PAN-30.24	104	PAN-36.61	114
PAN-25.65	101	PAN-30.30	107	PAN-36.62	114
PAN-25.70	101	PAN-30.34	106	PAN-36.63	114
PAN-25.71	101	PAN-30.47	002	PAN-36.64	114
PAN-25.81	099	PAN-30.56	056	PAN-37.18	114
PAN-25.82	099	PAN-30.59	056	PAN-37.22	114
PAN-25.83	099	PAN-30.65	108	PAN-37.23	114
PAN-25.84	099	PAN-30.66	108	PAN-37.25	114
PAN-25.85	099	PAN-30.72	107	PAN-38.17	115
PAN-25.86	099	PAN-31.19	109	PAN-38.19	115
PAN-25.87	099	PAN-31.20	109	PAN-38.20	115
PAN-25.88	099	PAN-31.48	109	PAN-39.10	115
PAN-25.89	099	PAN-31.55	109	PAN-39.12	115
PAN-25.90	099	PAN-31.60	109	PAN-39.14	115
PAN-26.30	101	PAN-31.65	109	PAN-39.16	115
PAN-27.55	102	PAN-31.69	109	PAN-40.01	115
PAN-27.62	102	PAN-31.75	109	PAN-40.02	115
PAN-28.04	102	PAN-32.20	110	PAN-40.03	115
PAN-28.07	102	PAN-32.22	110	PAN-40.20	115
PAN-28.09	102	PAN-32.23	110	PAN-40.53	116
PAN-28.12	102	PAN-33.12	110	PAN-41.02	116
PAN-28.16	102	PAN-33.21	110	PAN-41.60	117
PAN-28.20	102	PAN-33.93	107	PAN-41.04	116
PAN-28.24	102	PAN-33.94	107	PAN-41.07	116
PAN-28.27	102	PAN-33.97	107	PAN-41.10	116
PAN-28.29	102	PAN-34.22	111	PAN-41.12	116
PAN-28.32	102	PAN-34.23	111	PAN-41.13	116
PAN-28.38	102	PAN-34.24	111	PAN-41.14	116
PAN-28.40	103	PAN-34.70	120	PAN-41.16	116
PAN-28.44	103	PAN-34.75	120	PAN-41.17	116
PAN-28.50	103	PAN-35.08	112	PAN-41.18	116
PAN-28.53	103	PAN-35.10	112	PAN-41.20	116
PAN-28.54	103	PAN-35.12	112	PAN-41.30	117
PAN-28.55	103	PAN-35.15	112	PAN-41.34	117
PAN-28.56	103	PAN-35.30	112	PAN-41.35	117
PAN-28.63	103	PAN-35.32	112	PAN-41.39	116
PAN-28.65	103	PAN-35.34	112	PAN-41.50	117
PAN-28.70	103	PAN-35.36	112	PAN-41.51	117
PAN-28.72	104	PAN-36.12	112	PAN-41.52	117
PAN-28.73	104	PAN-36.14	112	PAN-41.53	117
PAN-28.74	104	PAN-36.16	112	PAN-41.54	117

Item No.	Page No.	Item No.	Page No.	Item No.	Page No.
PAN-41.56	117	PAN-65.15	043	PAS-09.17	081
PAN-41.61	117	PAN-66.15	043	PAS-09.27	081
PAN-41.62	117	PAN-67.11	089	PAS-09.31	082
PAN-41.63	117	PAN-70.01	120	PAS-09.32	082
PAN-42.02	119	PAN-70.03	122	PAS-09.33	082
PAN-42.05	119	PAN-70.04	122	PAS-09.34	082
PAN-42.06	119	PAN-70.05	122	PAS-09.35	082
PAN-42.08	119	PAN-70.06	122	PAS-09.36	082
PAN-42.11	119	PAN-70.08	122	PAS-09.37	082
PAN-42.12	119	PAN-70.09	122	PAS-09.41	083
PAN-42.13	119	PAN-70.11	123	PAS-09.42	083
PAN-42.14	119	PAN-70.12	123	PAS-09.43	083
PAN-42.15	119	PAN-70.15	126	PAS-09.44	083
PAN-42.16	119	PAN-70.16	126	PAS-09.45	083
PAN-42.18	119	PAN-70.17	126	PAS-09.46	083
PAN-42.29	118	PAN-70.18	126	PAS-09.47	083
PAN-42.71	118	PAN-70.43	123	PAS-09.63	084
PAN-42.72	118	PAN-70.45	123	PAS-09.65	084
PAN-42.73	118	PAN-70.47	124	PAS-09.67	085
PAN-42.75	118	PAN-70.49	124	PAS-09.68	085
PAN-42.76	118	PAN-70.51	124	PAS-10.26	086
PAN-42.87	118	PAN-70.53	124	PAS-10.27	086
PAN-42.88	118	PAN-70.54	125	PAS-10.28	086
PAN-43.13	027	PAN-70.55	125	PAS-15.21	130
PAN-46.10	027	PAN-70.57	125	PAS-15.26	130
PAN-47.10	027	PAN-70.59	120	PAS-15.27	130
PAN-49.12	027	PAN-70.75	123		
PAN-50.03	121	PAN-75.07	123		
PAN-50.04	121	PAN-75.12	127		
PAN-50.06	121	PAN-81.31	127		
PAN-50.07	121	PAN-81.32	127		
PAN-50.08	121	PAN-82.11	127		
PAN-50.09	121	PAN-82.12	127		
PAN-50.10	121	PAN-82.20	127		
PAN-50.11	121	PAN-82.25	127		
PAN-50.12	121	PAN-82.80	127		
PAN-50.13	121	PAS-09.17	081		
PAN-50.14	121	PAN-84.00	002		
PAN-51.11	027	PAN-84.05	002		
PAN-51.134	028	PAP-40.17	128		
PAN-51.164	028	PAQ-06.10	128		
PAN-51.18	028	PAQ-07.15	128		
PAN-51.34	028	PAQ-13.45	128		
PAN-51.43	027	PAQ-14.60	128		
PAN-51.64	028	PAQ-18.00	128		
PAN-52.114	028	PAQ-18.11	128		
PAN-52.14	028	PAQ-18.12	128		
PAN-54.19	029	PAQ-18.13	128		
PAN-55.20	029	PAQ-19.00	129		
PAN-56.31	029	PAQ-19.05	129		
PAN-56.32	029	PAQ-19.06	129		
PAN-56.33	029	PAQ-19.07	129		
PAN-60.15	043	PAS-03.15	129		
PAN-62.13	043	PAS-03.34	130		
PAN-62.15	043	PAS-07.35	131		
PAN-64.15	043	PAS-07.36	131		
PAN-64.30	003	PAS-07.37	131		

**ALPHABETICAL INDEX**

---





Item Name	Page No.	Item Name	Page No.
<b>A</b>			
Abdominal retractor	076	Chin retractor	086
ADSON-BROWN Delicate forceps,dressing and tissue	039	Chisels	90,115,116
ADSON Delicate forceps dressing and tissue	038	Cinelli Osteotomes	115
ADSON Delicate forceps, tissue	039	CINELLI Rhinoplasty scissors	027
ADSON Delicate retractors	067	CLAUS-KILLIAN Septum gouges	090
ADSON-GRAEFE Delicate forceps, dressing and tissue	040	Cleft palate hooks	127
ADSON-TOENNIS Dissecting Scissors	014	Cleft palate raspatories	127,131
AIACH Forceps	064	COHEN Elevators	062
Alar hooks	094	COLLIER Needle holders	050
Alar retractors	094	Columella forceps	089
ALM Self-retaining retractors	079	CONVERSE-DERF Needle holders	057
Anthelx Cartilage file	099	CONVERSE Nasal file	101
Areola marker	073	CONVERSE Nasal retractors	096
ASCH Septum straightening forceps	105	CONVERSE Needle holders	050
Atraumatic breast dissector	074	CONVERSE Raspatories	109
AUFRICHT-GUBISCH Nasal retractors	096	CONVERSE Rhinoplasty knives	097
AUFRICHT Nasal rasps	100	CONVERSE Rhinoplasty scissors	027
AUFRICHT Nasal retractors	095-096	COPE Delicate retractors	066
AUFRICHT Rhinoplasty scissors	028	COPE-WALTER Nasal retractors	066
AUFRICHT-WALTER Nasal retractors	095	COTTLE Alar and skin hooks	094
<b>B</b>			
BABY-FARABEUF Retractors	071	COTTLE Alar retractors	095
BABY-METZENBAUM Delicate dissecting scissors	010	COTTLE Bone lever and splitting Osteotome	102
BALLENGER Chisels	090	COTTLE Bulldog scissors	027
BARBON-LUBET Nasal dressing forceps	088	COTTLE Cartilage crushers	120
BARSKY Skin hooks	068	COTTLE Chisels	102
BENICKE Delicate retractors	069	COTTLE Columella forceps	088
BERGMANN Delicate retractors	069	COTTLE Delicate retractors	069
Blade osteotomes	116	COTTLE Elevators	109
BLAKESLEY Nasal forceps	093	COTTLE-FOMON Septum forceps	104
BLAKESLEY-WEIL Ethmoid bone forceps	093	COTTLE-GUBISCH Chisels	102
BLAKESLEY-WEIL Nasal forceps	092	COTTLE-MASING Mucosa needle holders	056
Blepharoplasty scissors	022	COTTLE-MASING Rhinoplasty scissors	027
BLOCKSMA Cleft palate hooks	127	COTTLE Mallets	060
BLUME Osteotomes	115	COTTLE-McKENTY Raspatories	111
BOIES Nasal fracture elevator	109	COTTLE Nasal rasps	098
Bone bending pliers	107	COTTLE Nasal retractors	094
Bone bow spacer	003	COTTLE Nasal septum scissors	029
Bone instruments	120,107	COTTLE Nasal septum speculum	088
Bone lever	103	COTTLE Nasal specula	088
Bone mill	120	COTTLE-NEIVERT Nasal retractors	094
Bowl for marking colour	073	COTTLE Osteotomes	102
BOZEMANN (WERTHEIM) Needle holders	054	COTTLE Raspatories	062,108
Breast dissectors	074	COTTLE Rhinoplasty knives	097
Breast elevator	073	COTTLE Rhinoplasty scissors	026-027
Breast retractors	075	COTTLE Septum elevators	110
BROWN-ADSON Delicate forceps,dressing and tissue	039	COTTLE Tissue grasping forceps	043
BRUENINGS-LUC (HEYMANN) Nasal septum forceps	091	COTTLE Tunnelling elevator	111
BRUESER-KELLY Delicate dissecting scissors	015	COTTLE-WALTER Rhinoplasty scissors	026
Bulldog clamps	046	CRAIG Vomer forceps	091
Bulldog scissors	027	CRAIG-DOMNICK Vomer forceps	091
<b>C</b>			
Calipers	002-003	CRILE Delicate retractors	067
CAPLAN Nasal septum scissors	029	CRILE-WOOD Needle holders	052
Cartilage abraders	099	Curette	062
Cartilage crushers	120	Cylinder osteotomes	119
Cartilage cutting block	120	<b>D</b>	
Cartilage instruments	120	DEAN Gum scissors	025
Cartilage scissors	028	EBAKEY Tissue grasping forceps	041
CASTROVIEJO Calipers	003	Delicate dissecting scissors	006-022
CASTROVIEJO-EPKER Calipers	003	Delicate forceps, dressing and tissue	038-042
Channel retractors	086	Delicate forceps, tissue	043
Cheek retractors	130	Delicate retractors	065,072
		Delicate scissors	006-008
		DENHART Mouth gags	128
		DERF-CONVERSE Needle holders	051
		Dermatomes	036
		DESMARRES Lid retractors	081
		DIETHRICH Hemostatic forceps	046
		Dilation rods	121
		DINGMANN Cartilage abraders	099
		DINGMANN Mouth gags	128
		Dissecting scissors	006-022
		Dissectors	123

## Alphabetical Index

Item Name	Page No.	Item Name	Page No.
DOMNICK-CRAIG Vomer forceps	091	HALSEY Needle holders	051
<b>E</b>		HALSTED-MOSQUITO Hemostatic Forceps	047
Elevators	061-063,124,127	HARGIS Raspatories	113
EMMET Fistula hook	069	HARTMANN Nasal dressing forceps	091
ENTNER Ligature needles	125	HARTMANN Nasal specula	088
EPKER-CASTROVIEJO Calipers	003	Hemostatic forceps	046-048
Ethmoid bone forceps	092	HEYMANN Nasal septum forceps	091
EWALD-HUDSON Delicate forceps,dressing and tissue	038	HEYMANN Rhinoplasty scissors	025
<b>F</b>		Hook dissector	1074
Facelift marker	003	Hook scissors	126
FANOUS Dissecting Scissors	020	HOSPITAL-PROVIDENCE Hemostatic Forceps	048
FANOUS-GUBISCH Osteotomes	103	HUDSON-EWALD Delicate Forceps, Dressing and tissue	038
FANOUS Ostetotomes	103	HUMBY Delicate Retractors	069
FANOUS Rhinoplasty Scissors	028	HUMBY Dermatomes	036
FANOUS Undermining scissors	020	<b>I</b>	
FARABEUF-BABY Retractors	071	Iliac crest retractors	085
FARABEUF Retractors	071	Interdental osteotomes	115
Finger goniometer	002	IRIS Iris scissors	006
FINSEN Self-retraining retractors	079	Iris scissors	006
Fistula hook	069	<b>J</b>	
Fixation wire with needles	064	JACKSON Delicate retractors	128
Flexometer	002	JACKSON Tracheal hooks	068
FOMON COTTLE Septum forceps	104	JACOBSON-MICRO Hemostatic Forceps	047
FOMON GUBISCH Nasal rasps	101	JAMESON Calipers	002
FOMON Nasal rasps	100	JAMESON Delicate dissecting scissors	019
FOMON Osteotomes	115	JOSEPH Delicate dissecting scissors	017
FOMON Rhinoplasty scissors	121	JOSEPH Delicate retractors	068
Forceps, dressing and tissue	041	JOSEPH Nasal saws	098
FOX Gum scissors	023	JOSEPH Rhinoplasty knives	087
FOX Tissue grasping forceps	043	JOSEPH Rulers	002
FOX Tissue holding forceps	043	JOSEPH Septum cartilage knife	092
FRAZIER Dura and skin hooks	067	JOSEPH-MASING Septum raspatory	109
FREEMAN-GORNEY Dissecting Scissors	021	JOSEPH-PECK Delicate dissecting Scissors	118
FREEMAN-METZENBAUM Dissecting Scissors	015	<b>K</b>	
FREER Chisels	090	KAHRE Cleft palate raspatories	127
FREER Delicate retractors	069	KAYE Blepharoplasty scissors	022
FREER Elevators	062	KAYE Dissecting scissors	021
FREER Mucosa knife	090	KELLY-BRÜSER Delicate dissecting Scissors	015
FREER-OBWEGESER Raspatories	114	KELLY Dissecting scissors	016
FREER Raspatories	061	KELLY Stiich scissors	023
<b>G</b>		KILLIAN-CLAUS Septum gouges	090
GILLIES Delicates forceps,Dressing and tissue	041	KILLIAN Nasal specula	089
GILLIES Delicate Retractors	067	KILLIAN Septum gouges	090
GILLIES Needle Holders	055	KILNER Alar retractors	095
GILLIES-OBWEGESER Needle Holders	055	KILNER-GUBISCH Alar retractors	095
GILLIES-SLIM Needle holders	055	KISTLER Anthelix cartilage file	099
GIUNTA Rhinoplasty scissors	027	KLEINERT-KUTZ Skin hooks	068
GOLDMAN Septum fracture elevator	109	KNAPP Delicate dissecting scissors	008-009
GORNEY Dissecting scissors	020	Knife inserts	121
GORNEY-FREEMAN Dissecting Scissors	021	Knives	121
GRAEFE-ADSON Delicate forceps, Dressing and tissue Grasping forceps	126	KOCHER Retractors	072
GREENGERG PAR delicate dissecting Scissors	017	KRETSCHMER Reference pin	002
GREEN-LANGENBECK Delicate Retractors	067	KUTZ-KLEINERT Skin hooks	068
GREEN-SENN Delicate retractors	067	<b>L</b>	
GRUENWALD bayonet forceps	042	LAHEY-CLINICH Dura and skin hooks	070
GUBISCH-AUFRICHT Nasal Retractors	096	LANGENBECK Elevators	061,063
GUBISCH Cartilage crushers	120	LANGENBECK-GREEN Delicate Retractors	067
GUBISCH-COTTEL Chisels	102	LANGENBECK Retractors	072
GUBISCH-FANOUS Osteotomes	103	LEPERT Raspatories	062
GUBISCH-FOMON Nasal rasps	101	LERICHE Hemostatic forceps	048
GUBISCH-KILNER Alar retractors	095	LEWIS Nasal rasps	099
GUBISCH Needle holders	051	LEXER-BABY Delicate dissecting Scissors	007
GUBISCH Osteotomes	116	LEXER Dissecting scissors	010
GUBISCH Pen holder	003	LEXER-MAYO Dissecting scissors	007
<b>H</b>		Lid grasping forceps	043

Item Name	Page No.
Lid retractors	081
Ligature needles	125
Lip instruments	127,130-131
Lip retractors	130
LITTAUER Stitch scissors	023
LITTLER Suture carrying scissors	021
LUBET-BARBON Nasal dressing Forceps	088
LUC-BRUENINGS (HEYMANN)	
Nasal Septum forceps	091

**M**

Mallets	060
MALTZ Nasal rasps	098
Mandibular rim retractor	081
Marking instruments	002-003
MARX Breast retractors	075
MASING Alar retractors	094
MASING-COTTLE Mucosa needle Holders	056
MASING-COTTLE Rhinoplasty scissors	027
MASING-JOSEPH Septum raspatory	109
MASING Nasal file	101
MASING Nasal rasps	101
MASING Septum elevators	110
MATHIEU Needle holders	056
Maxila mobilizer	118
MAYO Dissecting scissors	010
MAYO-HEGAR Needle holders	053
MAYO-LEXER Dissecting scissors	007
McINDOE Cartilage scissors	028
McINDOE Chisels	112
McINDOE Cleft palate raspatories	127
McINDOE Delicate forceps, Dressing and tissue	040
McKENTY-COTTLE Raspatories	111
McKENTY Raspatories	061
Measuring instruments	002-003
MERSHON Wire positioner	064
METZENBAUM-BABY Delicate Dissecting scissors	010
METZENBAUM Dissecting Scissors	010-111
METZENBAUM-FREEMANN Dissecting Scissors	015
METZENBAUM-NELSON Dissecting Scissors	012-013
METZENBAUM-SLIM Dissecting Scissors	013-014
MEYERDING Delicate retractors	071
MICRO-ADSON Delicate forceps, Dressing and tissue	042
MICRO-HALSTED Hemostatic forceps	049
MICRO-IRIS Iris scissors	006
MICRO-JACOBSON hemostatic Forceps	047
Micro Needle holders	057
MILLARD (COTTLE) Nasal retractors	094
MILLAR-SENN Delicate retractors	066
MINI-METZENBAUM Delicate Dissecting scissors	012
MOBERG Chisels	112
MOD. WIEN Nasal specula	089
MOLT mouth gags	128
MÖLTGEN Flexometer	002
MOSQUITO Hemostatic forceps	046
MOSQUITO-HALSTED Hemostatic Forceps	047
Mouth Gags	128
Mucoperiost retractors	131
Mucosa knife	061
Mucosa needle holders	056

**N**

NAGATA Elevators	061
NAGATA Needle holders	050
NAGATA Sculpture knives	035
Nasal dressing forceps	087
Nasal file	101
Nasal forceps	092-093
Nasal fracture elevator	109
Nasal rasps	98-100

Item Name	Page No.
Nasal retractors	94-95
Nasal ridge scissors	098
Nasal saws	098
Nasal septum forceps	091
Nasal septum osteotomes	118
Nasal septum scissors	029
Nasal septum speculum	088
Nasal specula	088-089
Nasal spine retractor	084
Navel Marker	077
Needle Holders	050-057
Needle holders with scissors	055
NEIVERT-COTTLE Nasal retractors	094
NEIVERT Nasal retractors	094
NEIVERT Needle holders	050
NELSON-METZENBAUM Dissecting Scissors	012-013
NELSON Tissue grasping forceps	041
Nerve Hooks	123-124
NEWS Tracheal hooks	068
NIRO Wire twisting forceps	064
Nose tip marker	002

**O**

O'BRIEN Stitch scisors	024
OBWEGESER Blade osteotomes	116
OBWEGESER Bone bending pliers	107
OBWEGESER Channel retractors	086
OBWEGESER Chin retractors	086
OBWEGESER-FREER Raspatories	113
OBWEGESER-GILLIES Needle Holders	055
OBWEGESER lilac crest retractors	085
OBWEGESER Interdental osteotomes	116
OBWEGESER Mandibular rim retractor	081
OBWEGESER Maxilla mobilizer	118
OBWEGESER Nasal rasps	100
OBWEGESER Nasal ridge scissors	029
OBWEGESER Nasal septum Osteotomes	118
OBWEGESER Nasal spine retractor	084
OBWEGESER Osteotomes	115-117
OBWEGESER Pterygoid osteotomes	117
OBWEGESER Ramus retractors	081
OBWEGESER Raspatories	112-113
OBWEGESER Rib raspatories	108
OBWEGESER Septum forceps	106
OBWEGESER Soft tissue retractors	082-083
OBWEGESER Splitting osteotomes	116
OBWEGESER Wedge osteotomes	116
OBWEGESER Wire loop forceps	064
OBWEGESER Wire twister	064
OBWEGESER Wisdom tooth retractor	084
Orbita floor raspatory	113
Orbital osteotomes	118
Osteotomes	111-118

**P**

PECK-JOSEPH Delicate Dissecting scissors	018
Pen Holder	003
PENNINGTON Elevators	090
PITANGUY facelift marker	003
PROVIDENCE-HOSPITAL Hemostatic Forceps	048
Pterygold osteotome	117

**R**

RAGNELL (KILNER) Delicate Dissecting scissors	016
RAGNELL Delicate retractor	066
Ramus retractors	081
Raspatiores	108-109,111,113,114,122
Reference pin	002
Retractor with fiber optic illumination	096
Retractors	066-072

## Alphabetical Index

Item Name	Page No.	Item Name	Page No.
REYNOLDS (JAMESON)		TIECK-HALLE Nasal specula	088
Dissecting Scissors	024-029	Tissue grasping forceps	041,043
Rhinoplasty knives	097	Tissue holding forceps	043
Rhinoplasty scissors	024-029	TOENNIS-ADSON Dissecting scissors	014
Rib raspatories	108	Tongue depressor	128-129
Rib raspatories	086	Tracheal hooks	068
ROSER KOENIG Mouth gags	128	Trocars	119
RUBIN Chisels	112	TROELTSCH (WILDE) Tissue grasping Forceps	042
RUBIN-GUBISCH Septal morselizer Forceps	107	Tunnelling raspatory	111
RUBIN Osteotomes	103		
RUBIN Septal morselizer forceps	107	<b>U</b>	
Rulers	002	Undermining scissors	020
		UNIV. MINNESOTA Cheek retractors	130
<b>S</b>		UNIVERSAL Wire cutting scissors	024
SALDANHA-SOLZ Abdominal Retractors	076		
Scalpel blades	032-034	<b>V</b>	
Scalpel handles	032-034	Vestibule retractor	130
Scalpels	032-034	Vomer forceps	091
SCHINK Dermatomes	036		
SCHROM Osteotomes	104	<b>W</b>	
Scissors	006-030	WALKER-THOMSON (BOZEMANN)	
Sculpture knives	035	Needle holder	054
Self-retaining retractors	079-080	WALSHAM Septum straightening Forceps	104
SEMKEN Delicate retractors Dressing and tissue	040	WALSHAM "UNIVERSAL" Septum Forceps	104
SENN-GREEN Delicate retractors	066	WALTER-AUFRICHT Nasal retractors	095
SENNING Needle holder	054	WALTER-COPE Nasal retractors	066
SENN-MILLER Delicate retractors	066	WALTER-COTTLE Rhinoplasty scissors	026
Septal morselizer forceps	107	WALTER Lid grasping forceps	043
Septum cartilage knives	106	WALTER Osteotomes	104
Septum elevators	109	WALTER Raspatories	062
Septum forceps	104	WALTER Retractors	071
Septum fracture elevator	090	WALTER Rhinoplasty scissors	026
Septum gouges	102	WALTER Tissue grasping forceps	041
Septum raspatory	062	WALTER-WILLIGER Curette	062
Septum straightening forceps	104-105	WANG Lip and cleft palate Instruments	063
SHEPARD Cylinder osteotomes	119	WANG Raspatories	063
SIEGERT Undermining scissors	016	WANG Mouth gags	129
SILVER Dermatomes	036	WATSON Dermatomes	036
SILVER Osteotomes	115	WATSON Forceps, dressing and tissue	041
Skin hooks	068	Wedge osteotomes	116
SLIM Delicate dissecting scissors	018	WEIL-BALKESLEY Ethmoid bone Forceps	092
SLIM-GILLIES Needle holders	055	WEIL-BLAKESLEY Nasal forceps	093
SLIM-METZENBAUM Dissecting Scissors	013-014	WEITLANER Self-retaining retractors	080
Soft tissue retractors	082-083	WESTMACOTT Nasal dressing Forceps	087
SOLZ Areola marker	073	WIENER MOD. Nasal specula	089
SOLZ Atraumatic breast dissector	074	WILLIGER Raspatories	061
SOLZ Dissecting scissors	032	WILLIGER-WALTER Curette	062
SOLZ Hook dissector	074	Wire cutting scissors	024
SOLZ Navel marker	077	Wire Instruments	064
SPENCER Stitch scissors	023	Wire loop forceps	064
Splitting osteotome	104,116	Wire pusher	064
STEINHAEUSER Orbita floor raspatory	114	Wire twister	064
STEINHAEUSER Orbital osteotomes	118	Wire twisting forceps	064
STERNBERG Cheek retractors	129	Wires	064
STEVENS Delicate dissecting Scissors	007	Wisdom tooth retractor	084
STEVENS Iris scissors	007	WOOD-CRILE Needle holders	052
STILLE-MAYO Dissecting scissors	009	WRIGHT (DERF) Needle holders	051
STILLE-STRANDELL Delicate Retractors	067		
Stitch scissors	023	<b>Y</b>	
STRAIGHT Dura and skin hooks	068	YANKAUER Septum elevator	109
STRANDELL-STILLE Delicate Retractors	067		
Suction elevator	110		
Suction raspatories	107		
Suture carrying scissors	027		
Sutruing forceps	042		
<b>T</b>			
TEBBETTS Retractors	078		
TESSIER Osteotomes	117		
TESSIER Raspatories	114		
THOMSON-WALKER (BOZEMANN)			
Needle holder	054		
THORPE Calipers	002		

# Surgical-i

Precision | Performance | Innovation

Suite 45, Lenton business centre  
Nottingham  
NG7 2BY  
Tel: (+44) 115 888 2020  
Email: [info@surgicali.com](mailto:info@surgicali.com)  
website: [www.surgical-i.com](http://www.surgical-i.com)