

Bone Surgery
Orthopadie
Cirurgia Para Huesos
Chirurge Osseuse

Surgical-i
Precision | Performance | Innovation

www.surgical-i.com

Index

| | |
|-------------------------------------|-------|
| Probes | 2 |
| Suction tubes | 2 |
| Scissors, delicate | 2 |
| Scissors, standard | 3 |
| Scissors, TC | 4,5 |
| Scalpel handles | 6 |
| Dissecting forceps, standard | 7 |
| Dissecting forceps, TC | 7 |
| Dressing and sponge holding forceps | 8 |
| Hemostatic forceps | 8-11 |
| Dissecting & ligature forceps | 12 |
| Towel forceps | 12 |
| Needle holders, standard | 13 |
| Needle holders, TC | 13,14 |
| Retractors, Hand | 15 |
| Retractors, self retaining | 16 |
| Sterilization | 17,18 |

Inhaltsverzeichnis

| | |
|-----------------------------|-------|
| Sonden | 2 |
| Saugkanülen | 2 |
| Feine scheren | 2 |
| Standard scheren | 3 |
| TC-scheren | 4,5 |
| Skalpellgriffe | 6 |
| Anatomische pinzetten | 7 |
| TC-Pinzetten | 7 |
| Tupfer-und schwammzangen | 8 |
| Arterienklemmen | 8-11 |
| Präparier & ligaturklemmen | 12 |
| Tuchklemmen | 12 |
| Standard Nadelhalter | 13 |
| TC-Nadelhalter | 13,14 |
| Wundhaken | 15 |
| Wundspreizer, selbsthaltend | 16 |
| Sterilisation | 17,18 |

Page

Indice

| | |
|---------------------------------------|-------|
| Sondas | 2 |
| Cánulas de aspiración | 2 |
| Tijeras finas | 2 |
| Tijeras standard | 3 |
| Tijeras-TC | 4,5 |
| Mangos de bisturios | 6 |
| Pinzas de disección | 7 |
| Pinzas-TC | 7 |
| Pinzas para tapones y esponjas | 8 |
| Pinzas hemostáticas | 8-11 |
| Pinzas para preparaciones y ligaduras | 12 |
| Pinzas para compresas y de camp | 12 |
| Porta agujas, standard | 13 |
| Porta agujas-TC | 13,14 |
| Separadores | 15 |
| Separadores con retenida automática | 16 |
| Esterilización | 17,18 |

Sommaire

| | |
|-----------------------------------|-------|
| Sondes | 2 |
| Canules à aspiration | 2 |
| Ciseaux fins | 2 |
| Ciseaux standard | 3 |
| Ciseaux-TC | 4,5 |
| Manches pour bistouris | 6 |
| Pinces à disséquer | 7 |
| Pinces-TC | 7 |
| Pinces à tampons et éponges | 8 |
| Pinces hémostatique | 8-11 |
| Pince à dissection et à ligatures | 12 |
| Pinces à compresse et à champs | 12 |
| Porte-aiguilles standard | 13 |
| Porte-aiguilles-TC | 13,14 |
| Ecarteurs | 15 |
| Ecarteurs autostatiques | 16 |
| Sterilisation | 17,18 |

Página

Index

| | |
|------------------------------|-------|
| Plaster of paris | 20,21 |
| Mallets | 22-24 |
| Bone files, rasps | 25 |
| Elevators | 26-30 |
| Raspatories | 28-30 |
| Bone levers | 31-33 |
| Bone cutting forceps | 34-36 |
| Bone holding forceps | 37-43 |
| Amputation & resection saws | 44 |
| Wire forceps | 45-47 |
| Chisels, gouges & osteotomes | 48-54 |
| Bone curettes | 55-59 |
| Bone rongeurs | 60-67 |
| Hand bone drills | 68 |
| Finger ring saws | 68 |
| Nail instruments | 68 |

Inhaltsverzeichnis

| | |
|-------------------------------------|-------|
| Gips / verband | 20,21 |
| Hämmer | 22-24 |
| Knochenfeilen, raspeln | 25 |
| Elevatoren | 26-30 |
| Raspatorien | 28-30 |
| Knochenhebel | 31-33 |
| Knochensplitterzangen | 34-36 |
| Knochenhalte-zangen | 37-43 |
| Amputations & resektionssägen | 44 |
| Drahtzangen | 45-47 |
| Flachmeißel, hohlmeißel & osteotome | 48-54 |
| Scharfe löffel | 55-59 |
| Hohlmeißelzangen | 60-67 |
| Handbohrapparate | 68 |
| Fingerring-sägen | 68 |
| Nagelzange | 68 |

Page

Indice

| | |
|-------------------------------------|-------|
| Vendajes enyesados | 20,21 |
| Martillos y mazos | 22-24 |
| Limas para huesos, Escofinas | 25 |
| Elevadores | 26-30 |
| Periostótomos | 28-30 |
| Elevadores para huesos | 31-33 |
| Pinzas cortantes para huesos | 34-36 |
| Pinzas para huesos | 37-43 |
| Sierras para amputación y resección | 44 |
| Pinzas para hilos | 45-47 |
| Cinceles, Gubias y Osteótomos | 48-54 |
| Cucharillas cortantes | 55-59 |
| Pinzas gubias | 60-67 |
| Perforadores de mano para huesos | 68 |
| Sierras para abrir anillos | 68 |
| Pinza para uñas | 68 |

Sommaire

| | |
|--------------------------------------|-------|
| Bandage plâtrès | 20,21 |
| Maillets | 22-24 |
| Limes à os, Râpes à os | 25 |
| Elévateurs | 26-30 |
| Rugines | 28-30 |
| Levier à os | 31-33 |
| Pinces coupantes | 34-36 |
| Daviers | 37-43 |
| Scies à amputation et résection | 44 |
| Pinces à fil | 45-47 |
| Ciseaux-Burins, Gouges et Ostéotomes | 48-54 |
| Curettes tranchantes | 55-59 |
| Pinces gouges | 60-67 |
| Perforateur à main | 68 |
| Scies pour bagues et | 68 |
| Pince à ongle | 68 |

Página



General Surgery

Surgical-i

Precision | Performance | Innovation

Probes

Sonden

Sondas

Sondes



PB. 02.13 13 cm
PB. 02.14 14.5 cm
PB. 02.16 16 cm
PB. 02.18 18 cm

PB. 07.13 13 cm
PB. 07.14 14.5 cm
PB. 07.18 18 cm

Suction tubes

Saugkanülen

Cánulas de aspiración

Canules à aspiration

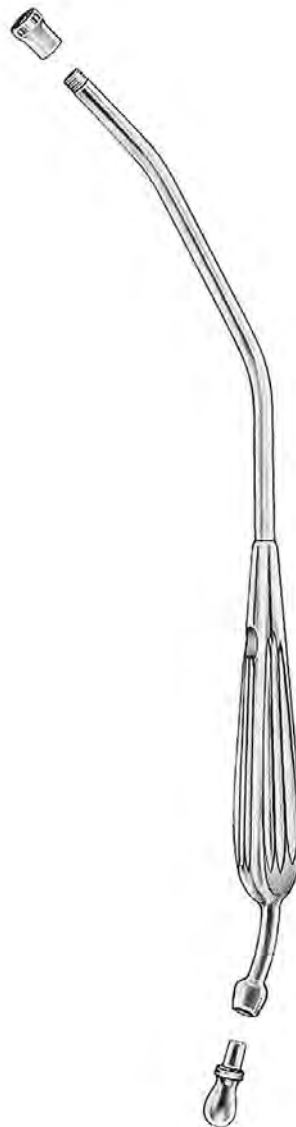

Delicate scissors

Feine Scheren
Tijeras finas
Ciseaux fins



| | | |
|------------------|-------------|------------------|
| | IRIS | |
| <i>Straight</i> | | <i>Curved</i> |
| PC. 01.09 | 9 cm | PC. 02.09 |
| PC. 01.10 | 10.5 cm | PC. 02.10 |
| PC. 01.11 | 11.5 cm | PC. 02.11 |



| | | |
|------------------|--------------------|------------------|
| | Blunt/Blunt | |
| <i>Straight</i> | | <i>Curved</i> |
| PC. 14.11 | 11.5 cm | PC. 18.11 |
| PC. 14.13 | 13 cm | PC. 18.13 |
| PC. 14.14 | 14.5 cm | PC. 18.14 |
| PC. 14.16 | 16.5 cm | PC. 18.16 |



| | | |
|------------------|--------------------|------------------|
| | Sharp/Sharp | |
| <i>Straight</i> | | <i>Curved</i> |
| PC. 15.11 | 11.5 cm | PC. 19.11 |
| PC. 15.13 | 13 cm | PC. 19.13 |
| PC. 15.14 | 14.5 cm | PC. 19.14 |
| PC. 15.16 | 16.5 cm | PC. 19.16 |



| | | |
|------------------|--------------------|------------------|
| | Sharp/Blunt | |
| <i>Straight</i> | | <i>Curved</i> |
| PC. 16.11 | 11.5 cm | PC. 17.11 |
| PC. 16.13 | 13 cm | PC. 17.13 |
| PC. 16.14 | 14.5 cm | PC. 17.14 |
| PC. 16.16 | 16.5 cm | PC. 17.16 |



| | | |
|------------------|-------------|------------------|
| | MAYO | |
| <i>Straight</i> | | <i>Curved</i> |
| PC. 24.14 | 14 cm | PC. 25.14 |
| PC. 24.15 | 15.5 cm | PC. 25.15 |
| PC. 24.17 | 17 cm | PC. 25.17 |
| PC. 24.23 | 23 cm | PC. 25.23 |

| | | |
|------------------|------------------------|------------------|
| | MAYO-HARRINGTON | |
| <i>Straight</i> | | <i>Curved</i> |
| PC. 24.60 | 20 cm | PC. 25.60 |
| PC. 24.63 | 23 cm | PC. 25.63 |

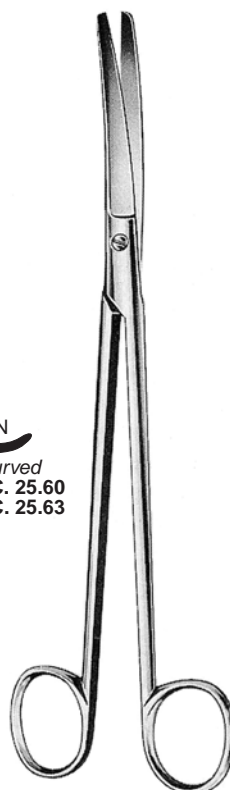

| | | |
|------------------|--------------------|------------------|
| | MAYO-STILLE | |
| <i>Straight</i> | | <i>Curved</i> |
| PC. 28.15 | 15 cm | PC. 30.15 |
| PC. 28.17 | 17 cm | PC. 30.17 |
| PC. 28.23 | 23 cm | PC. 30.23 |

Operating and dissecting scissors, PROLONG TC®

Operations - und Präparierscheren, PROLONG TC®

Tijeras para cirugía y preparaciones, PROLONG TC®

Ciseaux à chirurgie et dissection, PROLONG TC®

Scissors with tungsten carbide cutting edges



Dissecting scissors, PROLONG TC®
 Präparierscheren, PROLONG TC®
 Tijeras para preparaciones, PROLONG TC®
 Ciseaux à dissection, PROLONG TC®

Scissors with tungsten carbide cutting edges





METZENBAUM (LAHEY)

| | | |
|---|-------|---|
|  <i>Straight</i> | |  <i>Curved</i> |
| PC. 36.64 | 14 cm | PC. 37.64 |





METZENBAUM

| | | |
|---|-------|---|
|  <i>Straight</i> | |  <i>Curved</i> |
| PC. 38.68 | 18 cm | PC. 39.68 |
| PC. 38.70 | 20 cm | PC. 39.70 |



NELSON (METZENBAUM)

| | | |
|---|-------|---|
|  <i>Straight</i> | |  <i>Curved</i> |
| PC. 40.73 | 23 cm | PC. 41.73 |
| PC. 40.76 | 26 cm | PC. 41.76 |
| PC. 40.80 | 30 cm | PC. 41.80 |

Surgical-i

Precision | Performance | Innovation

Scalpel handles

Skalpellgriffe

Mangos de bisturios

Manches pour bistouris



NO. 3
PE. 04.03
12 cm



NO. 4
PE. 09.04
13 cm



NO. 7
PE. 05.07
16 cm



NO. 3 L
PE. 07.13
21 cm

Dissecting forceps
 Anatomische Pinzetten
 Pinzas de disección
 Pincés à disséquer

Dissecting forceps, PROLONG TC®
 Anatomische Pinzetten, **PROLONG TC®**
 Pinzas de disección, **PROLONG TC®**
 Pincés à disséquer, **PROLONG TC®**



STANDARD
 PF. 01.10 10.5 cm
 PF. 01.11 11.5 cm
 PF. 01.13 13 cm
 PF. 01.14 14.5 cm
 PF. 01.16 16 cm
 PF. 01.18 18 cm
 PF. 01.20 20 cm
 PF. 01.25 25 cm
 PF. 01.30 30 cm

STANDARD 1 x 2
 PF. 05.10 10.5 cm
 PF. 05.11 11.5 cm
 PF. 05.13 13 cm
 PF. 05.14 14.5 cm
 PF. 05.16 16 cm
 PF. 05.18 18 cm
 PF. 05.20 20 cm
 PF. 05.25 25 cm
 PF. 05.30 30 cm

ADSON
 PF. 15.12 12 cm
 PF. 15.15 15 cm

MICRO-ADSON
 PF. 17.12 12 cm
 PF. 18.15 15 cm

ADSON
 PF. 16.12 12 cm
 PF. 16.15 15 cm

MICRO-ADSON
 PF. 19.12 12 cm
 PF. 20.15 15 cm

Forceps with tungsten carbide tips

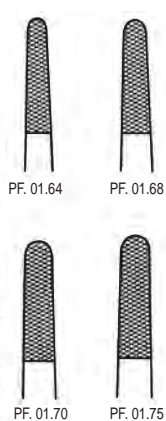

**ATRAUMATIC
 PROLONG TC®**
 PF. 01.64 14.5 cm
 PF. 01.68 18 cm
 PF. 01.70 20 cm
 PF. 01.75 25 cm

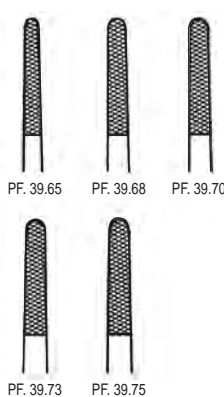

POTTS-SMITH
 PF. 39.65 15 cm
 PF. 39.68 18 cm
 PF. 39.70 20 cm
 PF. 39.73 23 cm
 PF. 39.75 25 cm



ADSON
 PF. 15.62 12 cm



ADSON
 PF. 15.65 15 cm



ADSON
 PF. 16.62 12 cm
 PF. 16.65 15 cm

Dressing & sponge holding forceps

Tupfer- und Schwammzangen
Pinzas para tapones y esponjas
Pincas à tampons et éponges

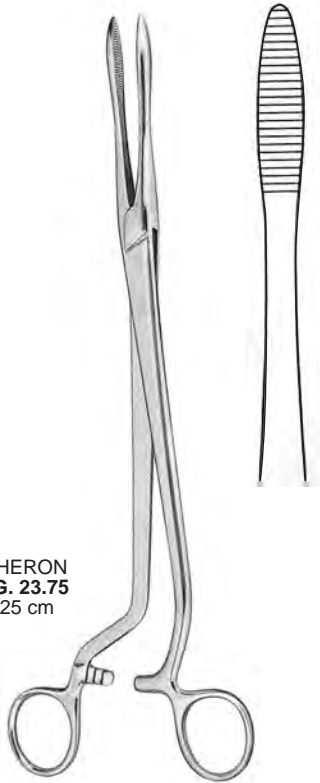

CHERON
PG. 23.75
25 cm

Hemostatic forceps

Arterienklemmen
Pinzas hemostáticas
Pincas hémostatique

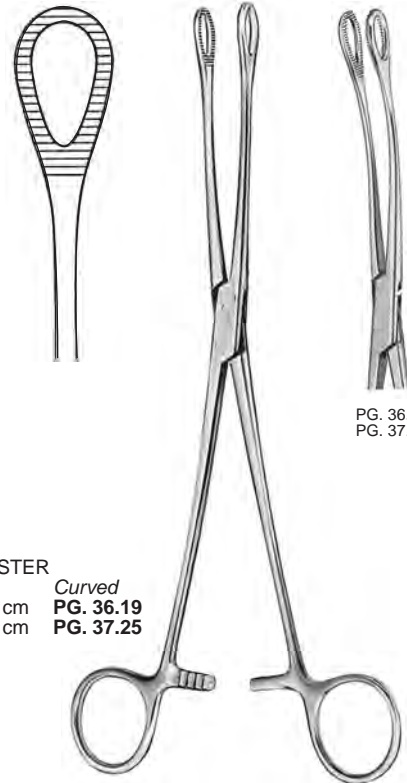

FOERSTER
Straight PG. 36.18 18 cm
Curved PG. 36.19 24 cm
PG. 37.24 PG. 37.25

PG. 36.19
PG. 37.25



HALSTED-MOSQUITO
Straight PH. 10.12 12.5 cm
Curved PH. 11.12

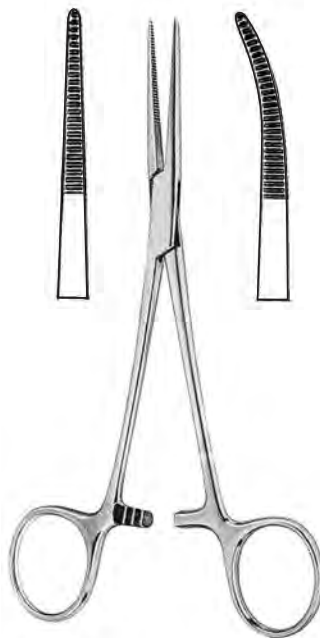

RANKIN-KELLY
Straight PH. 42.14 14 cm
PH. 44.16 16 cm
Curved PH. 43.14
PH. 45.16



RANKIN-CRILE
Straight PH. 46.14 14 cm
PH. 48.16 16 cm
Curved PH. 47.14
PH. 49.16

Surgical-i

Precision | Performance | Innovation

Hemostatic forceps

Arterienklemmen

Pinzas hemostáticas

Pinces hémostatique

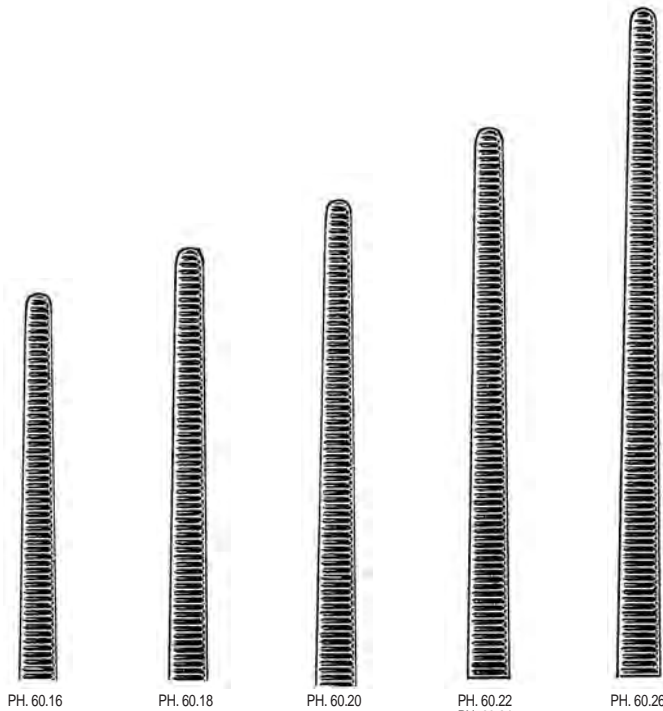

PH. 60.16

PH. 60.18

PH. 60.20

PH. 60.22
PH. 60.24

PH. 60.26

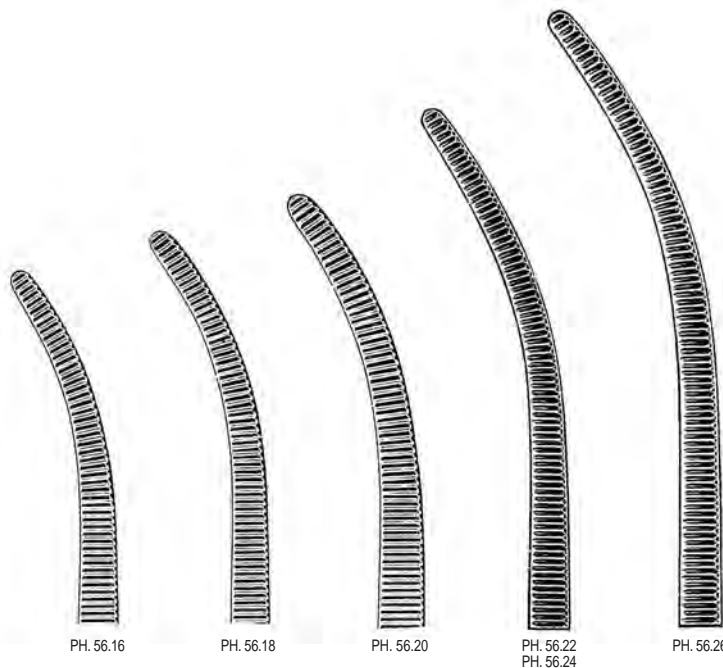

PH. 56.16

PH. 56.18

PH. 56.20

PH. 56.22
PH. 56.24

PH. 56.26



ROCHESTER-PEAN

| <i>Straight</i> | | <i>Curved</i> |
|-----------------|-------|---------------|
| PH. 60.16 | 16 cm | PH. 56.16 |
| PH. 60.18 | 18 cm | PH. 56.18 |
| PH. 60.20 | 20 cm | PH. 56.20 |
| PH. 60.22 | 22 cm | PH. 56.22 |
| PH. 60.24 | 24 cm | PH. 56.24 |
| PH. 60.26 | 26 cm | PH. 56.26 |

Hemostatic forceps

Arterienklemmen

Pinzas hemostáticas

Pinces hémostatique



PH. 62.16



PH. 62.18



PH. 62.20



PH. 62.22
PH. 62.24



PH. 62.26



PH. 63.16



PH. 63.18



PH. 63.20



PH. 63.22
PH. 63.24



PH. 63.26



ROCHESTER-OGHSNER

Straight

PH. 62.16

PH. 62.18

PH. 62.20

PH. 62.22

PH. 62.24

PH. 62.26

Curved

PH. 63.16

PH. 63.18

PH. 63.20

PH. 63.22

PH. 63.24

PH. 63.26

Hemostatic forceps

Arterienklemmen

Pinzas hemostáticas

Pinces hémostatique

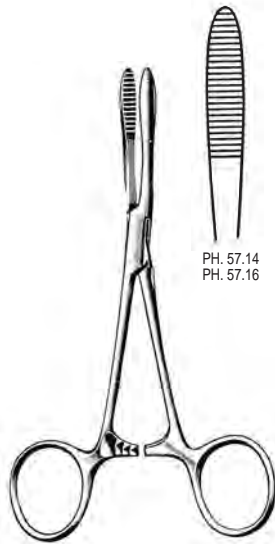

PH. 57.14
PH. 57.16

PEAN
PH. 57.14 14 cm
PH. 57.16 16 cm



PH. 66.14

PH. 66.13

PH. 67.13

PH. 67.14

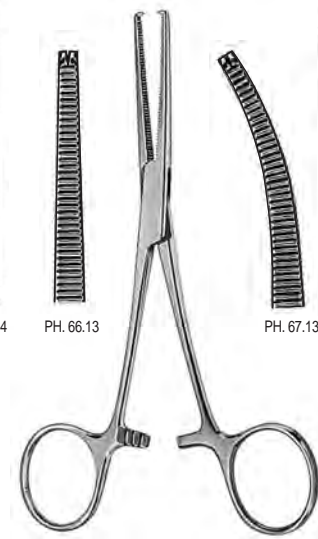

KOCHER

Straight
PH. 66.13 13 cm
PH. 66.14 14 cm

13 cm
14 cm

Curved
PH. 67.13 13 cm
PH. 67.14 14 cm

13 cm
14 cm



PH. 73.23

PH. 73.24

MOYNIHAN
PH. 73.23 23 cm
PH. 73.24 24 cm

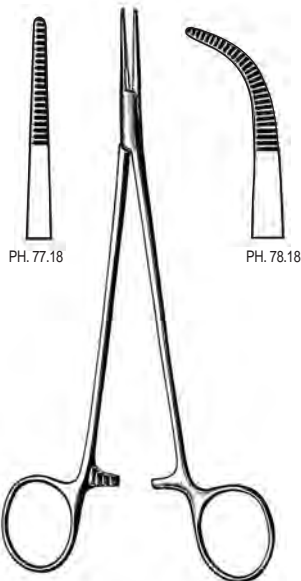

PH. 77.18

PH. 78.18

HALSTED (ADSON)
Straight PH. 77.18 18 cm
Curved PH. 78.18

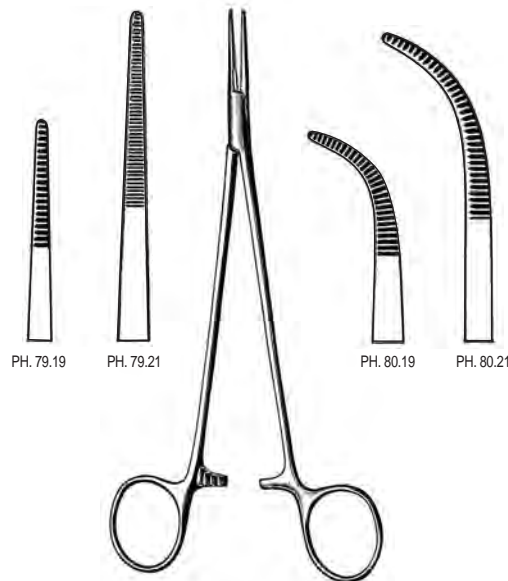

PH. 79.19

PH. 79.21

PH. 80.19

PH. 80.21

ADSON

Straight
PH. 79.19 18.5 cm
PH. 79.21 18.5 cm

18.5 cm
18.5 cm

Curved
PH. 80.19 18.5 cm
PH. 80.21 18.5 cm

Dissecting & ligature forceps

Präparier- & Ligaturklemmen

Pinzas para preparaciones y ligaduras

Pince à dissection et à ligatures

Towel forceps

Tuchklemmen

Pinzas para compresas y de campo

Pinces à compresses et à champs



PI. 03.14

MIXTER-BABY
PI. 03.14 14 cm

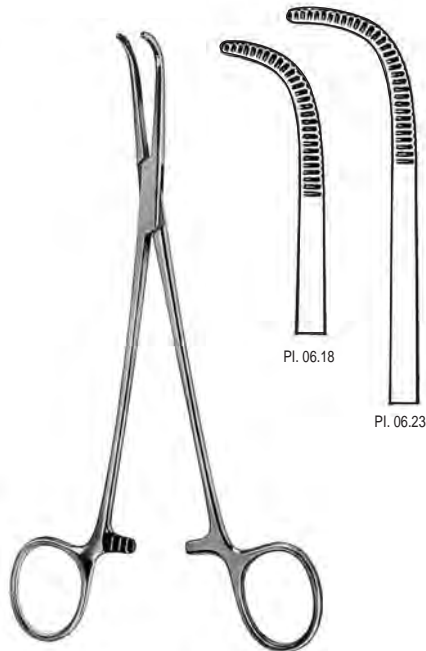

PI. 06.18

PI. 06.23

MIXTER
PI. 06.18 18 cm
PI. 06.23 23 cm



PI. 08.14

PI. 08.18

PI. 08.20

GEMINI
PI. 08.14 14 cm
PI. 08.18 18 cm
PI. 08.20 20 cm

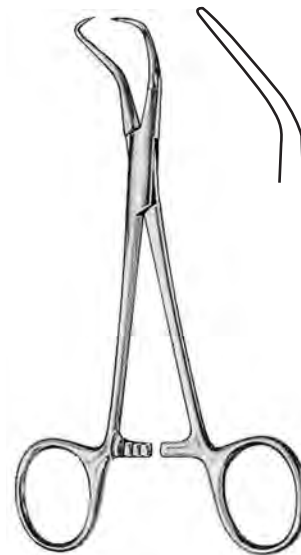

BACKHAUS
PI. 25.08 8 cm
PI. 25.10 11 cm
PI. 26.13 13 cm
PI. 26.15 15 cm

Needle holders

Nadelhalter

Porta agujas

Porte aiguilles

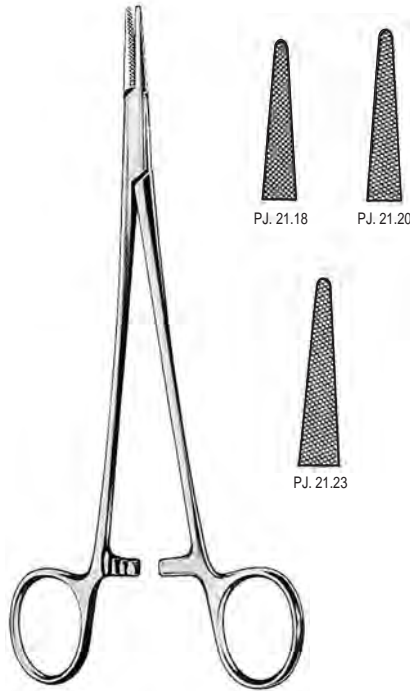

CRILE-WOOD
PJ. 21.18 18 cm
PJ. 21.20 20 cm
PJ. 21.23 23 cm

Needle holders, PROLONG TC®

Nadelhalter, PROLONG TC®

Porta agujas, PROLONG TC®

Porte aiguilles, PROLONG TC®

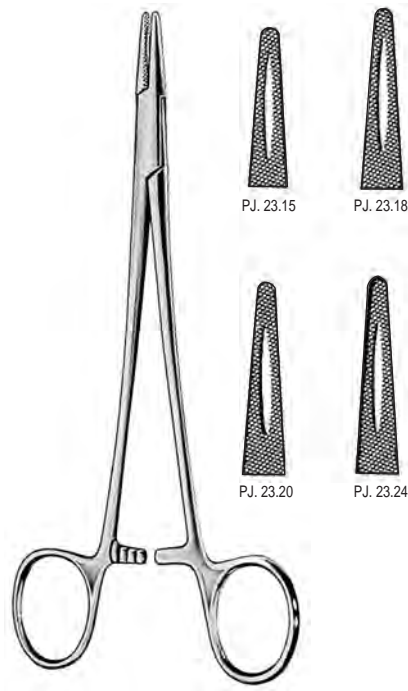

MAYO-HEGAR
PJ. 23.15 15 cm
PJ. 23.18 18 cm
PJ. 23.20 20 cm
PJ. 23.24 24 cm



CRILE-WOOD
PJ. 34.15 15 cm

Needle holders with tungsten carbide jaws

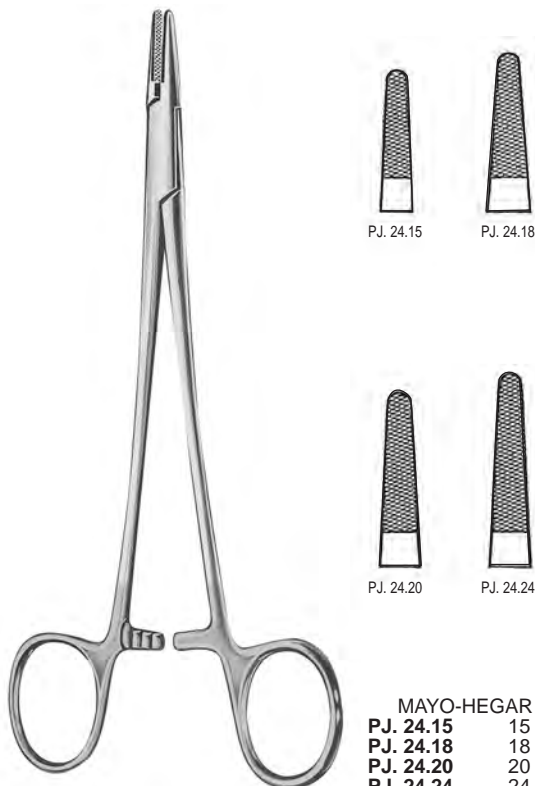

MAYO-HEGAR
PJ. 24.15 15 cm
PJ. 24.18 18 cm
PJ. 24.20 20 cm
PJ. 24.24 24 cm

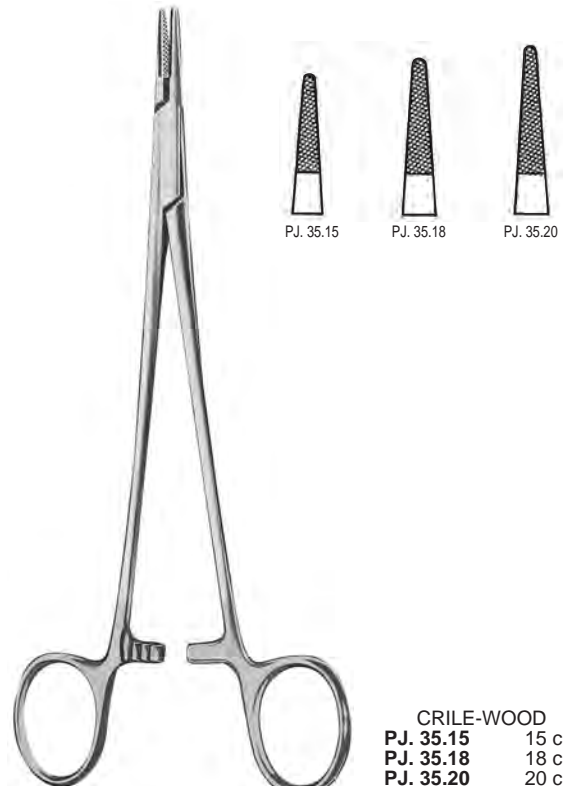

CRILE-WOOD
PJ. 35.15 15 cm
PJ. 35.18 18 cm
PJ. 35.20 20 cm

Needle holders, PROLONG TC®

Nadelhalter, PROLONG TC®

Porta agujas, PROLONG TC®

Porte aiguilles, PROLONG TC®

Needle holders with tungsten carbide jaws

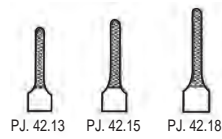

PJ. 42.13 PJ. 42.15 PJ. 42.18

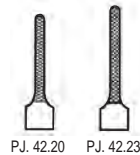

PJ. 42.20 PJ. 42.23



**RYDER
(FRENCH EYE)**

| | |
|------------------|-------|
| PJ. 42.13 | 13 cm |
| PJ. 42.15 | 15 cm |
| PJ. 42.18 | 18 cm |
| PJ. 42.20 | 20 cm |
| PJ. 42.23 | 23 cm |

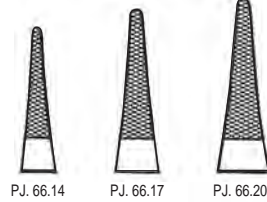

PJ. 66.14 PJ. 66.17 PJ. 66.20



MATHIEU-KOCHER

| | |
|------------------|-------|
| PJ. 66.14 | 14 cm |
| PJ. 66.17 | 17 cm |
| PJ. 66.20 | 20 cm |

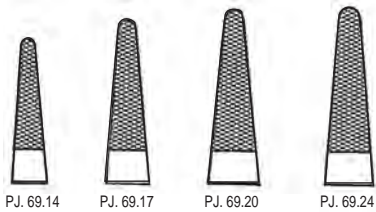

PJ. 69.14 PJ. 69.17 PJ. 69.20 PJ. 69.24



MATHIEU

| | |
|------------------|-------|
| PJ. 69.14 | 14 cm |
| PJ. 69.17 | 17 cm |
| PJ. 69.20 | 20 cm |
| PJ. 69.24 | 24 cm |

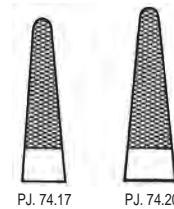

PJ. 74.17 PJ. 74.20



MATHIEU

| | |
|------------------|-------|
| PJ. 74.17 | 17 cm |
| PJ. 74.20 | 20 cm |

Surgical-i

Precision | Performance | Innovation

Retractors

Wundhaken
Separadores
Ecarteurs

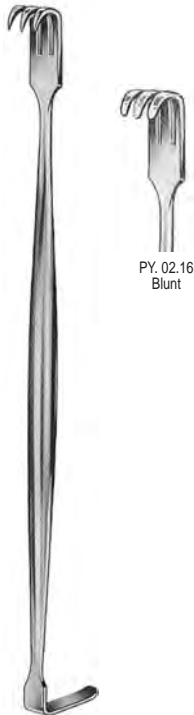

SENN-MUELLER
PY. 01.16 16 cm Sharp
PY. 02.16 16 cm Blunt



FARABEUf-BABY
PY. 46.12 12 cm



FARABEUf
PY. 47.15 15 cm



VOLKMAN
 22 cm

PY. 59.22 Sharp
PY. 60.22 Blunt

PY. 59.23 Sharp
PY. 60.23 Blunt

PY. 59.24 Sharp
PY. 60.24 Blunt



LANGENBECK
PY. 71.10 21 cm
PY. 71.13 21 cm
PY. 71.16 21 cm



PY. 71.10
PY. 72.10
 10 x 40 mm



PY. 71.13
PY. 72.13
 13 x 42 mm



PY. 71.16
PY. 72.16
 16 x 42 mm



LANGENBECK
PY. 72.10 21 cm
PY. 72.13 21 cm
PY. 72.16 21 cm

Self-retaining retractors

Wundspreizer, selbsthaltend

Separadores con retenida automática

Ecarteurs autostatiques

Laminectomy retractors

Laminektomie-Wundspreizer

Separadores para laminectomía

Ecarteurs pour laminectomie

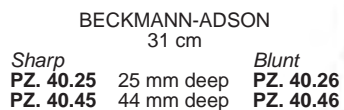

Sterilization

Sterilisation
Esterilizacion
Sterilisation



CHEATLE
PR. 03.27 27 cm

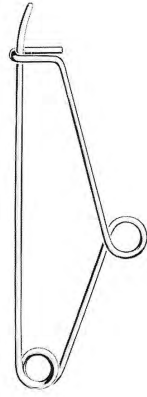

MAYO
PR. 10.14 14 cm



SCHIMMELBUSCH

| | ∅ | h |
|-----------|----|-------|
| PR. 25.14 | 14 | 14 cm |
| PR. 25.16 | 16 | 15 cm |
| PR. 25.19 | 19 | 16 cm |
| PR. 25.20 | 19 | 19 cm |
| PR. 25.24 | 24 | 12 cm |
| PR. 25.25 | 24 | 16 cm |
| PR. 25.27 | 24 | 24 cm |
| PR. 25.29 | 29 | 16 cm |
| PR. 25.30 | 29 | 24 cm |
| PR. 25.34 | 34 | 16 cm |
| PR. 25.35 | 34 | 24 cm |
| PR. 25.39 | 39 | 14 cm |
| PR. 25.40 | 39 | 19 cm |
| PR. 25.41 | 39 | 29 cm |



KONRICH

| | ∅ | h |
|-----------|----|-------|
| PR. 26.14 | 14 | 14 cm |
| PR. 26.16 | 16 | 15 cm |
| PR. 26.19 | 19 | 16 cm |
| PR. 26.20 | 19 | 19 cm |
| PR. 26.24 | 24 | 12 cm |
| PR. 26.25 | 24 | 16 cm |
| PR. 26.27 | 24 | 24 cm |
| PR. 26.29 | 29 | 16 cm |
| PR. 26.30 | 29 | 24 cm |
| PR. 26.34 | 34 | 16 cm |
| PR. 26.35 | 34 | 24 cm |
| PR. 26.39 | 39 | 14 cm |
| PR. 26.40 | 39 | 19 cm |
| PR. 26.41 | 39 | 29 cm |

Inserts for KONRICH

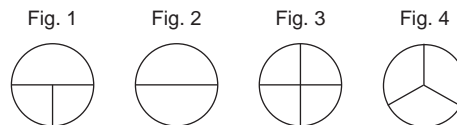

| | | | | ∅ | h |
|-----------|-----------|-----------|-----------|----|-------|
| PR. 27.14 | PR. 28.14 | PR. 29.14 | PR. 30.14 | 14 | 14 cm |
| PR. 27.16 | PR. 28.16 | PR. 29.16 | PR. 30.16 | 16 | 15 cm |
| PR. 27.19 | PR. 28.19 | PR. 29.19 | PR. 30.19 | 19 | 16 cm |
| PR. 27.20 | PR. 28.20 | PR. 29.20 | PR. 30.20 | 19 | 19 cm |
| PR. 27.24 | PR. 28.24 | PR. 29.24 | PR. 30.24 | 24 | 12 cm |
| PR. 27.25 | PR. 28.25 | PR. 29.25 | PR. 30.25 | 24 | 16 cm |
| PR. 27.27 | PR. 28.27 | PR. 29.27 | PR. 30.27 | 24 | 24 cm |
| PR. 27.29 | PR. 28.29 | PR. 29.29 | PR. 30.29 | 29 | 16 cm |
| PR. 27.30 | PR. 28.30 | PR. 29.30 | PR. 30.30 | 29 | 24 cm |
| PR. 27.34 | PR. 28.34 | PR. 29.34 | PR. 30.34 | 34 | 16 cm |
| PR. 27.35 | PR. 28.35 | PR. 29.35 | PR. 30.35 | 34 | 24 cm |
| PR. 27.39 | PR. 28.39 | PR. 29.39 | PR. 30.39 | 39 | 14 cm |
| PR. 27.40 | PR. 28.40 | PR. 29.40 | PR. 30.40 | 39 | 19 cm |
| PR. 27.41 | PR. 28.41 | PR. 29.41 | PR. 30.41 | 39 | 29 cm |

Sterilization
Sterilisation
Esterilizacion
Sterilisation



| | |
|-------------------|-------------------|
| PAF. 04.15 | 150 x 100 x 25 mm |
| PAF. 04.20 | 200 x 150 x 40 mm |
| PAF. 04.25 | 250 x 200 x 50 mm |
| PAF. 04.30 | 300 x 250 x 50 mm |
| PAF. 04.35 | 350 x 300 x 50 mm |
| PAF. 04.40 | 400 x 300 x 50 mm |
| PAF. 04.45 | 450 x 350 x 50 mm |



| | |
|------------------|--------------|
| PF. 08.85 | 85 x 85 mm |
| PF. 08.90 | 100 x 100 mm |
| PF. 08.92 | 120 x 120 mm |
| PF. 08.95 | 150 x 150 mm |



| | |
|-------------------|-------------------|
| PAF. 10.17 | 170 x 100 x 35 mm |
| PAF. 10.25 | 250 x 140 x 40 mm |
| PAF. 10.27 | 275 x 150 x 45 mm |
| PAF. 10.30 | 305 x 140 x 50 mm |



| | |
|-------------------|--------------|
| PAF. 12.07 | 165 x 60 mm |
| PAF. 12.10 | 175 x 70 mm |
| PAF. 12.25 | 225 x 90 mm |
| PAF. 12.45 | 275 x 115 mm |
| PAF. 12.60 | 290 x 125 mm |
| PAF. 12.85 | 345 x 125 mm |
| PAF. 12.91 | 380 x 125 mm |
| PAF. 12.94 | 405 x 150 mm |



| | |
|-------------------|--------------|
| PAF. 15.30 | 30 x 90 mm |
| PAF. 15.50 | 50 x 100 mm |
| PAF. 15.51 | 50 x 120 mm |
| PAF. 15.56 | 60 x 130 mm |
| PAF. 15.76 | 75 x 130 mm |
| PAF. 15.77 | 75 x 175 mm |
| PAF. 15.80 | 100 x 150 mm |



| | |
|-------------------|-------------------|
| PAF. 21.16 | 165 x 90 x 35 mm |
| PAF. 21.21 | 200 x 100 x 50 mm |
| PAF. 21.23 | 230 x 130 x 50 mm |
| PAF. 21.26 | 260 x 150 x 50 mm |
| PAF. 21.30 | 305 x 205 x 50 mm |



Orthopedics

Bandage scissors

Verbandscheren

Tijeras para vendajes

Ciseaux pour pansements

Cloth & plaster-of-paris shears

Kleiderstoff & Gippscheren

Tijeras para vestidos y Cizallas para yesos

Cisailles pour pansements et pour appareils plâtres

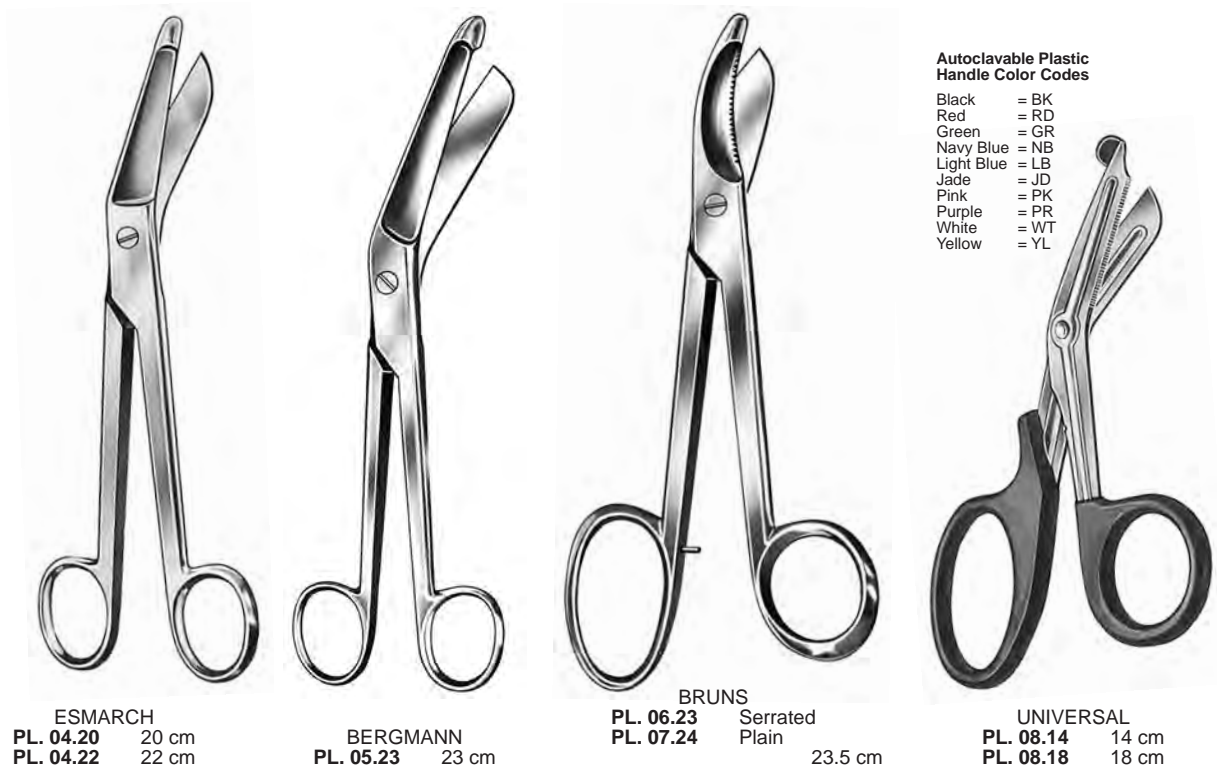

Scissors with tungsten carbide cutting edges

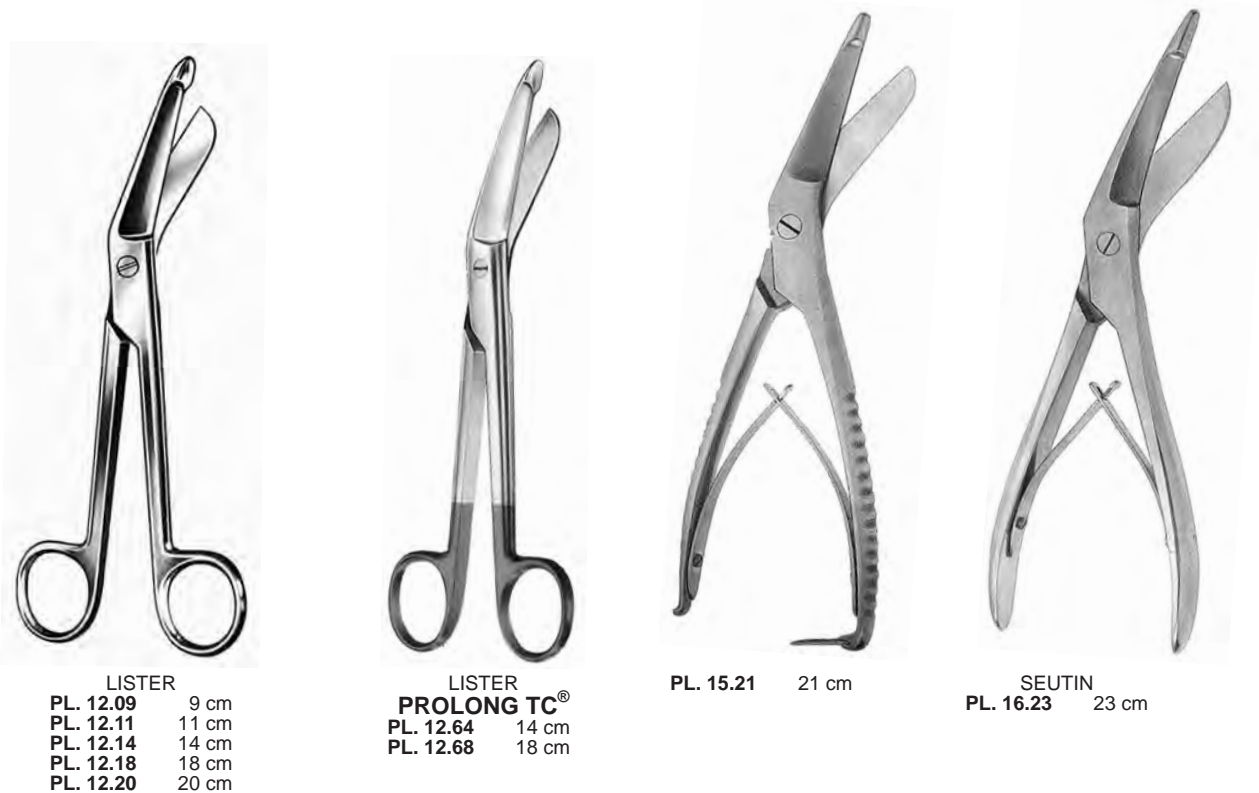

Plaster cast spreaders, Plaster-of-Paris shears

Gipsspreizer, Gipsscheren

Pinzas y Cizallas para romper los vendajes enyesados

Pinces et cisailles écartantes pour appareils plâtrés

Plaster-of-Paris knives & saw

Gipsmesser, Gipssäge

Cuchillos, Sierre de mano

Couteaux, Scie à main



STILLE
PQ. 01.23 23 cm
PQ. 01.26 26 cm
PQ. 01.37 37 cm



MOD. USA
PQ. 03.23 23 cm



WOLFF
PQ. 04.18 18 cm
PQ. 04.24 24 cm



HENNIG
PQ. 05.27 27 cm



BEESON
PQ. 06.30 30 cm



WIGMORE
PQ. 09.19 19 cm



ENGEL
PQ. 10.15 15 cm



ESMARCH
PQ. 11.18 18 cm



HOPKINS
PQ. 12.20 20 cm



REINER
PQ. 13.19 18.5 cm

Mallets

Hämmer

Martillos y Mazos

Maillets



Ø 40 mm
690 g

KIRK
PM. 02.20 19.5 cm

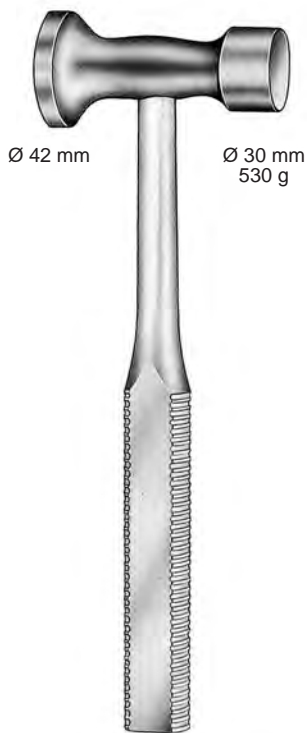

Ø 42 mm Ø 30 mm
530 g

PM. 05.24 24 cm



Ø 26 mm
320 g

MEAD
PM. 06.19 17 cm



Ø 30 mm
400 g

GERZOG
PM. 07.18 18 cm

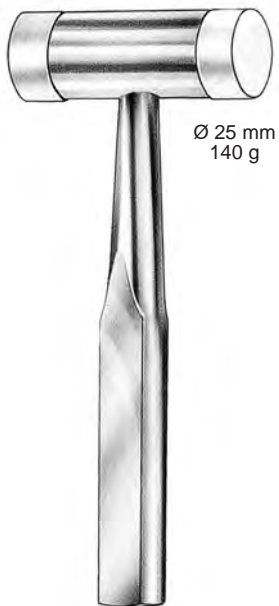

Ø 25 mm
140 g

PM. 08.18 18 cm

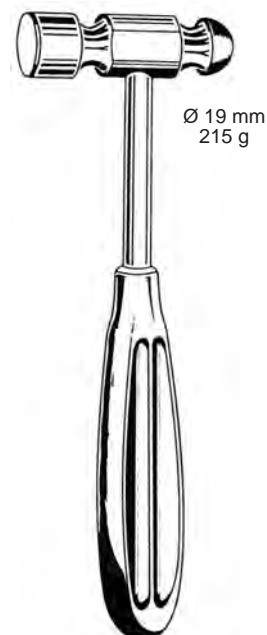

Ø 19 mm
215 g

PM. 09.19 19 cm

Mallets

Hämmer

Martillos y Mazos

Maillets



450 g

PM. 17.26 26.5 cm



900 g

PM. 18.26 26.5 cm



ø 20 mm
140 g

THIESS
PM. 20.16 16 cm



PM. 21.19
ø 19 mm
230 g

PM. 21.25
ø 25 mm
260 g

LUCAE
19 cm



ø 22 mm
200 g

PARTSCH
PM. 22.18 18 cm



ø 27 mm
140 g

HAJEK
PM. 24.22 22 cm



ø 30 mm
220 g

COLLIN
PM. 25.20 20 cm

Mallets

Hämmer

Martillos y Mazos

Maillets



PM. 27.30
ø 26 mm
300 g

PM. 27.34
ø 28 mm
340 g

PM. 27.40
ø 30 mm
400 g

WILLIGER
24 cm



PM. 30.12
ø 25 mm
120 g

PM. 30.18
ø 30 mm
180 g

PM. 30.26
ø 35 mm
260 g

DOYEN
20 cm



240 g

COTTLE
PM. 32.19 19 cm



300 g

BERGMANN
PM. 35.24 24 cm



300 g

BERGMANN
PM. 37.23 23 cm



550 g

OMBREDANNE
PM. 38.55 24 cm

Surgical-i

Precision | Performance | Innovation

Bone files, Rasps

Knochenfeilen, Raspeln

Limas para huesos, Escofinas

Limes à os, Râpes à os



PUTTI
PT. 04.28 28 cm



PUTTI
PT. 05.30 30 cm



PT. 06.22 22 cm



PT. 07.28 28 cm



PT. 08.24 24 cm

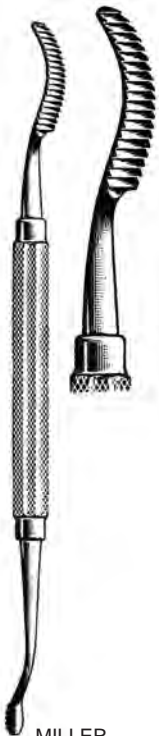

MILLER
PT. 10.30 18 cm

10

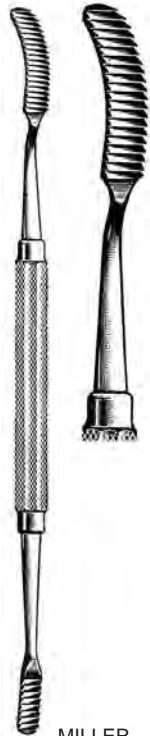

MILLER
PT. 10.40 18 cm

11

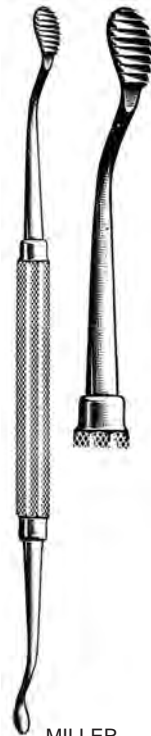

MILLER
PT. 10.45 18 cm

12

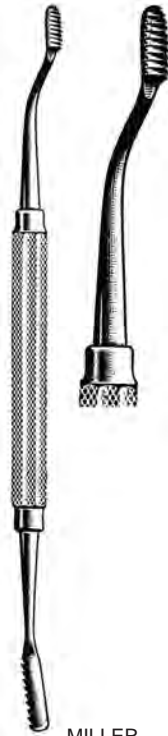

MILLER
PT. 10.50 18 cm

13

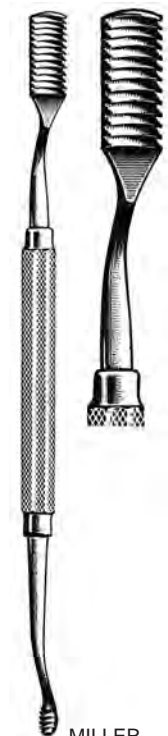

MILLER
PT. 10.55 18 cm

14

Elevators

Elevatorii
Elevadores
Elévateurs



WILLIGER
16 cm
PT. 12.04 4 mm

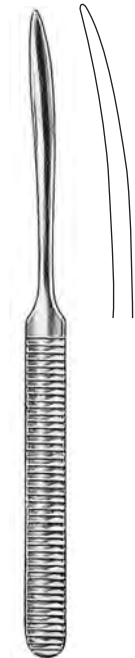

WILLIGER
16 cm
PT. 12.06 5.5 mm
PT. 12.07 7 mm



HOEN



PT. 14.07
16 cm

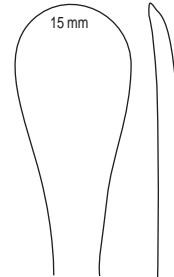

PT. 14.15
19 cm

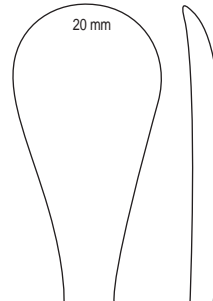

PT. 14.20
19 cm

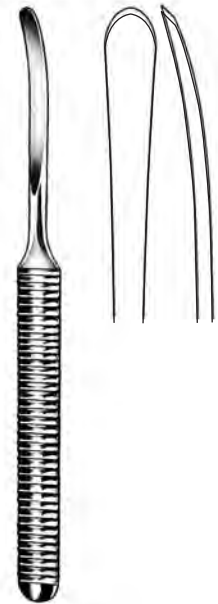

WILLIGER
16 cm
PT. 15.03 3 mm
PT. 15.05 5 mm
PT. 15.07 7 mm



McDONALD
PT. 18.19 19 cm



MOLT
PT. 19.18 18 cm



MOLT
PT. 19.19 18 cm



MOLT
PT. 19.20 18 cm



MOLT
PT. 19.21 18 cm



JOSEPH
PT. 22.16 16.5 cm

Surgical-i

Precision | Performance | Innovation

Elevators

Elevatori
Elevadores
Elévateurs



LEMPERT
17 cm



PT. 23.02
2 mm



PT. 23.03
3 mm



PT. 23.04
4 mm



PT. 23.05
5 mm



PT. 23.06
3.5 mm



ADSON
17 cm



PT. 26.01
9 mm



PT. 26.02
6 mm



PT. 26.04
6 mm



PT. 26.03
6 mm

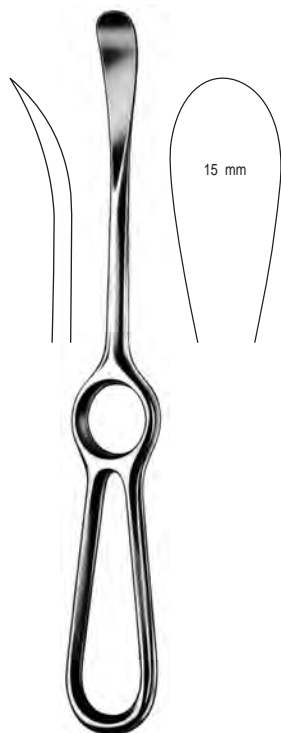

SEDILLOT
PT. 28.21 21 cm



PT. 29.18 18 cm



PT. 29.19 18 cm



PT. 29.20 18 cm



PT. 29.26 18 cm

Raspatories

Raspatorien
Periostótomos
Rugines

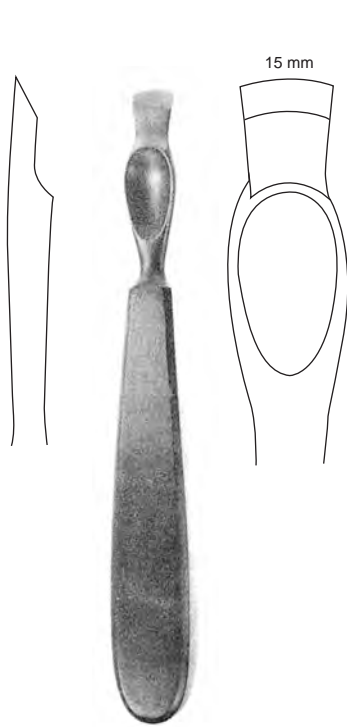

KIRMISSION
PT. 30.16 16.5 cm



SEMB



PT. 31.01
12 mm
20 cm



PT. 31.02
12 mm
24 cm



PT. 31.03
14 mm
20 cm



PT. 31.04
14 mm
24 cm



PT. 31.07
16 mm
24 cm



FARABEUFF
Straight PT. 32.15 15 cm
Curved PT. 32.16



PT. 33.20 19 cm



PT. 33.21 20 cm



PT. 33.22 20 cm



PT. 33.50 20 cm

Raspatories

Raspatorien
Periostótomos
Rugines

Elevators

Elevatorien
Elevadores
Elévateurs



PT. 34.06 6 mm
PT. 34.10 10 mm
PT. 34.15 15 mm
PT. 34.20 20 mm
PT. 34.25 25 mm

LAMBOTTE
21 cm

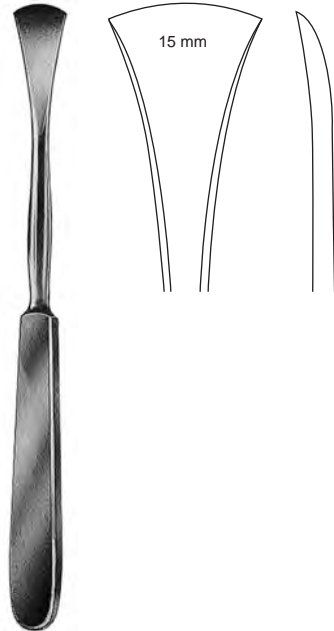

LANGENBECK
PT. 37.35 19 cm



LANGENBECK
PT. 37.63 18 cm

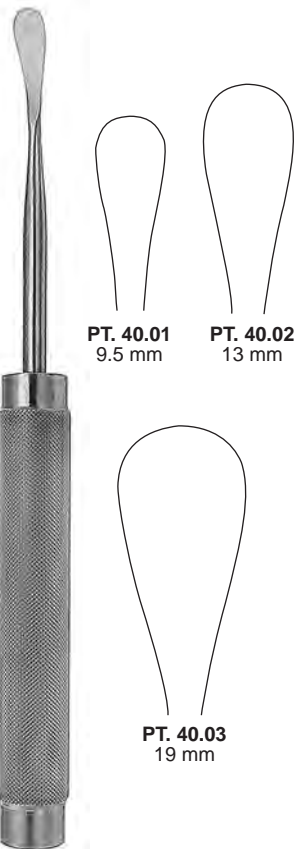

PT. 40.01 9.5 mm
PT. 40.02 13 mm

PT. 40.03
19 mm

COBB
28 cm



ALDERDYCE
PT. 41.21 21 cm



FREER
PT. 42.18 18 cm

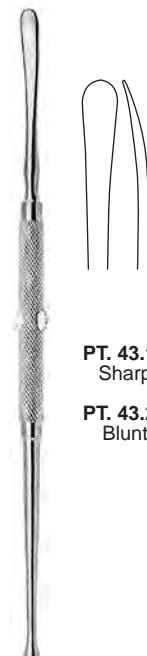

FREER
19 cm

PT. 43.19
Sharp

PT. 43.29
Blunt



PT. 44.18 17.5 cm



PT. 45.16 16 cm

Elevators

Elevatorien
Elevadores
Elévateurs

Raspatories

Raspatorien
Periostótomos
Rugines

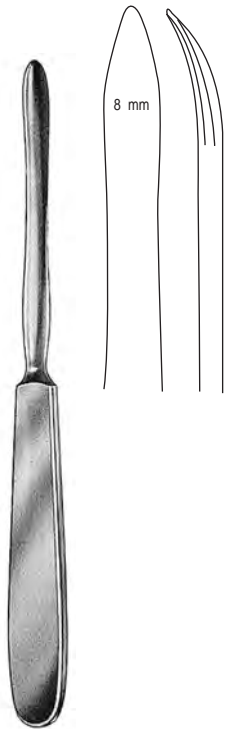

LANGENBECK
PT. 46.08 19.5 cm

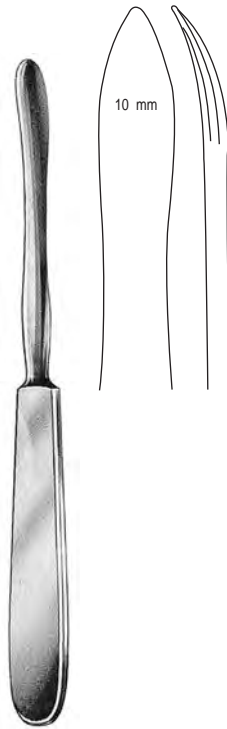

LANGENBECK
PT. 46.10 19.5 cm

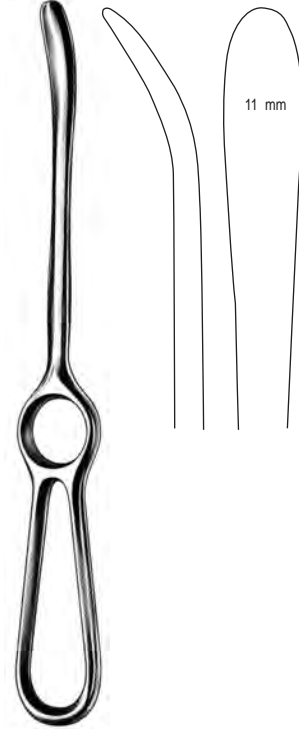

LANGENBECK
PT. 47.11 23 cm

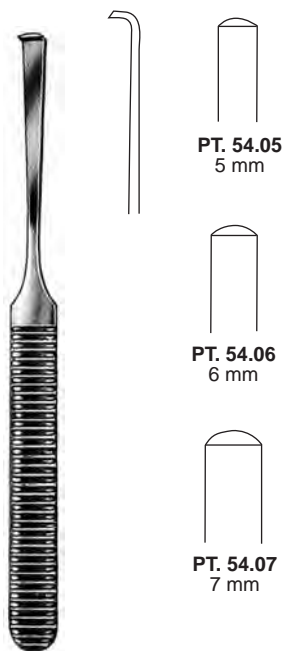

16 cm



DOYEN
17 cm

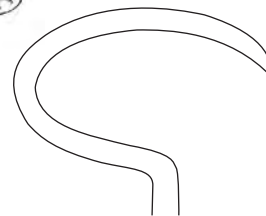

PAG. 46.11

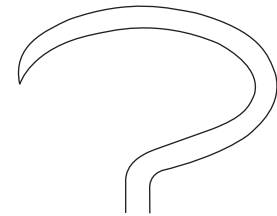

PAG. 46.12

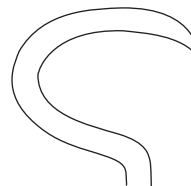

PAG. 46.21

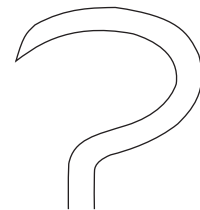

PAG. 46.22

Surgical-i

Precision | Performance | Innovation

Bone levers

Knochenhebel

Elevadores para huesos

Levier à os

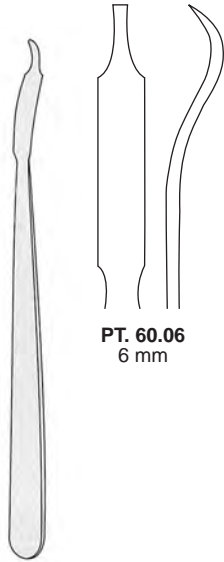

MINI-HOHMANN
16 cm

PT. 60.06
6 mm

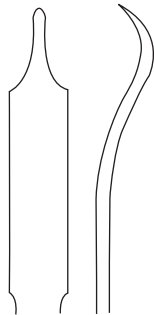

PT. 60.08
8 mm

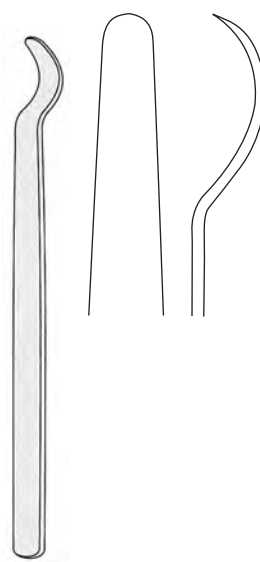

PT. 61.14
14 cm

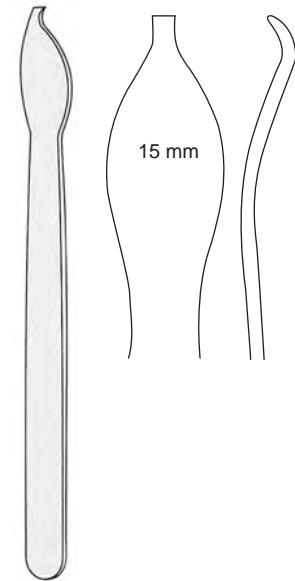

PT. 61.37
17 cm

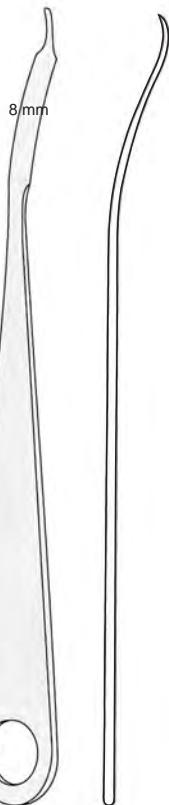

HOHMANN
PT. 62.08 22 cm

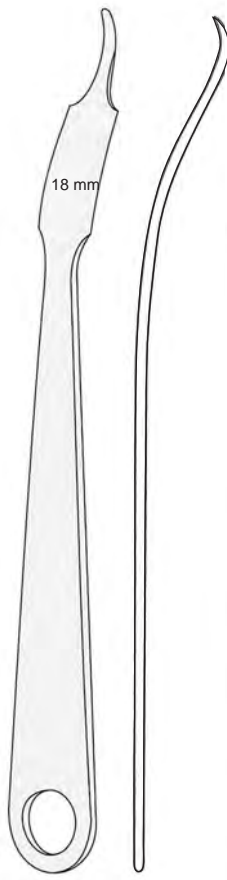

HOHMANN
PT. 62.18 24 cm

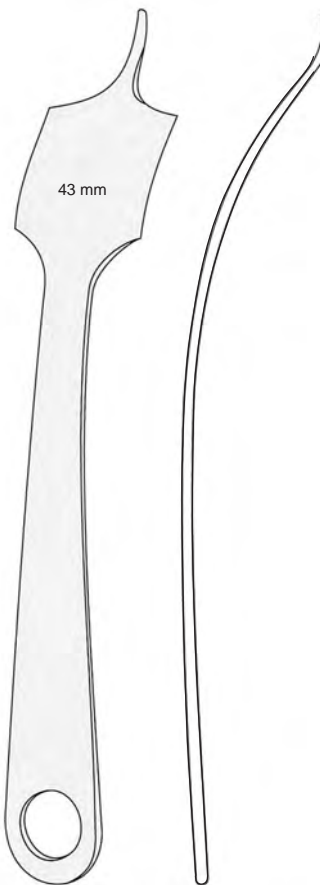

HOHMANN
PT. 62.43 26 cm

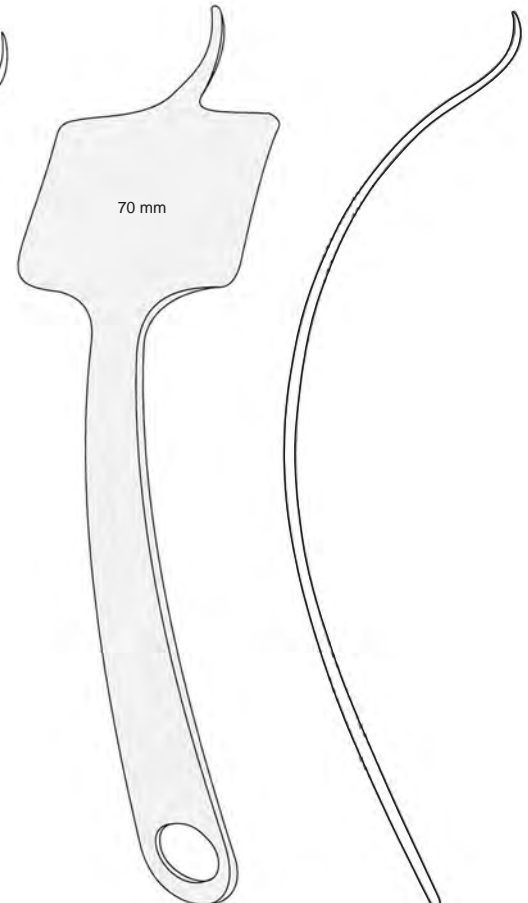

HOHMANN
PT. 62.70 29 cm

Bone levers
 Knochenhebel
 Elevadores para huesos
 Levier à os

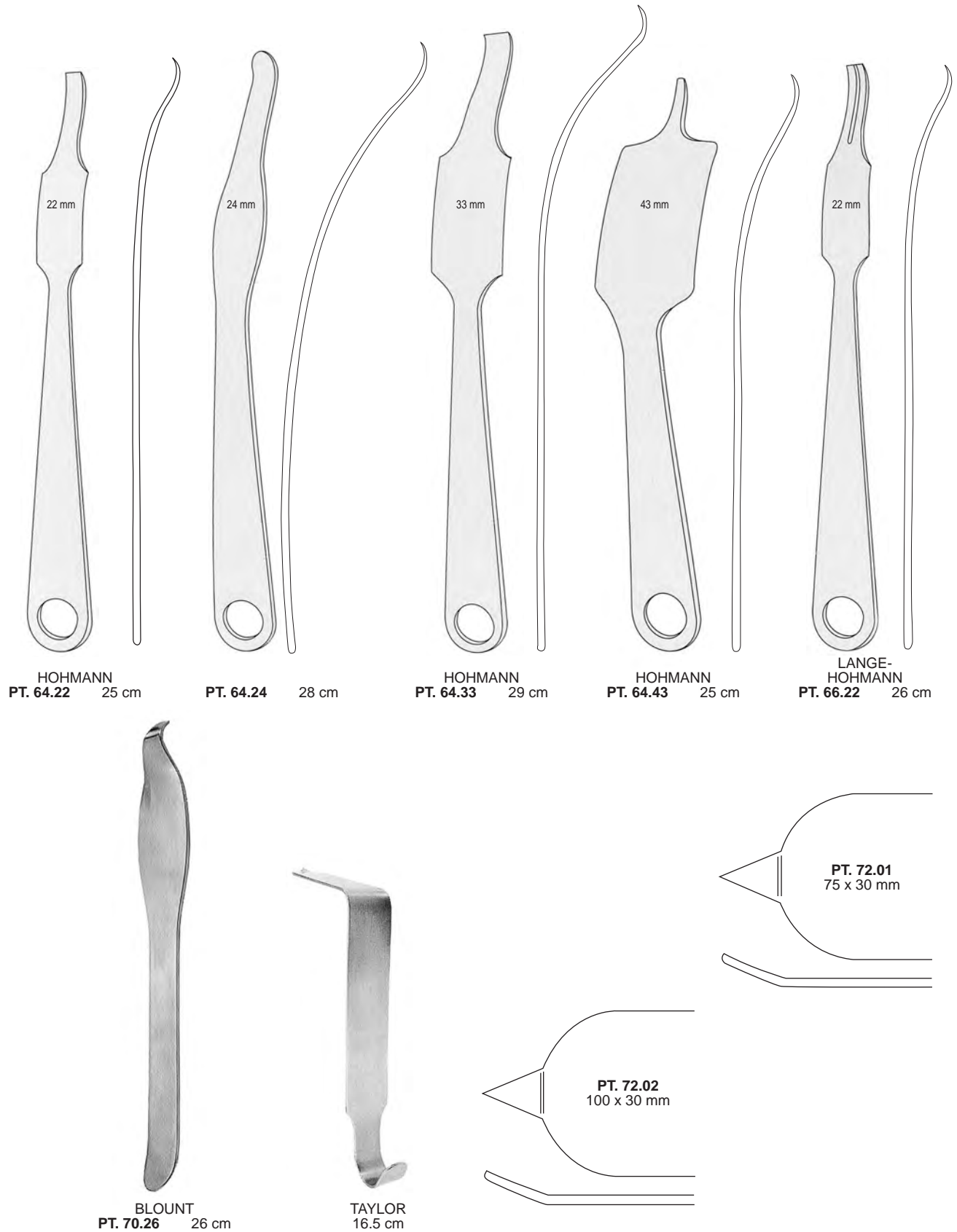

Knee retractors

Wund-und Meniskushaken

Separadores para rodilla

Ecarteurs pour le genou

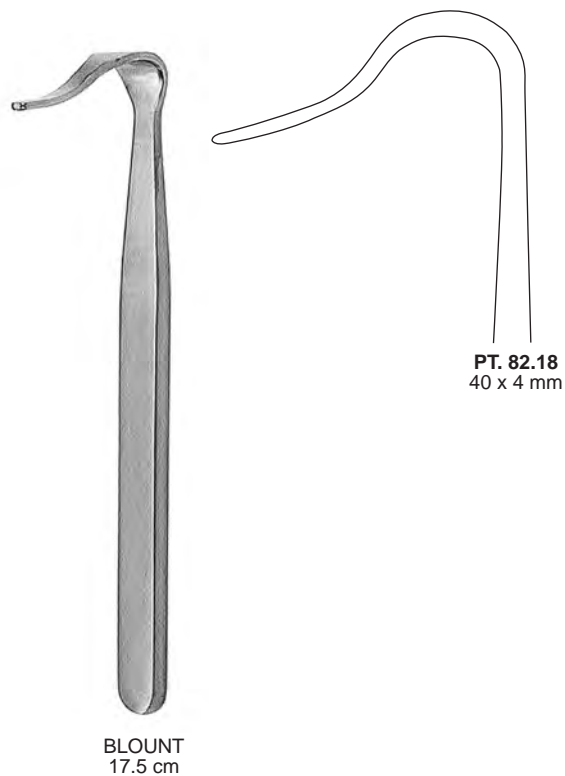
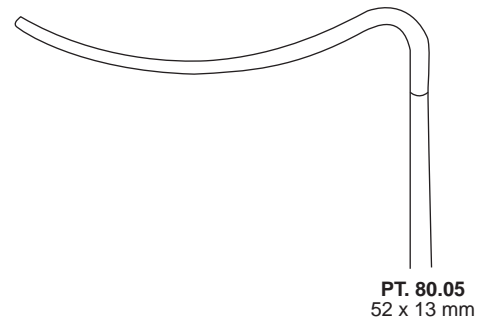
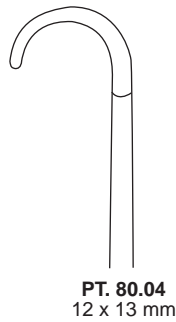
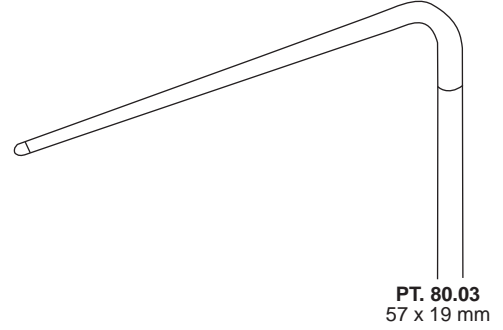
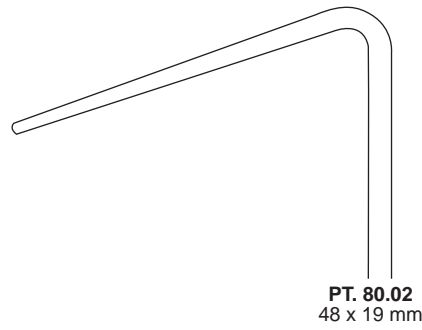

Bone cutting forceps

Knochensplitterzangen

Pinzas cortantes para huesos

Pincas coupantes

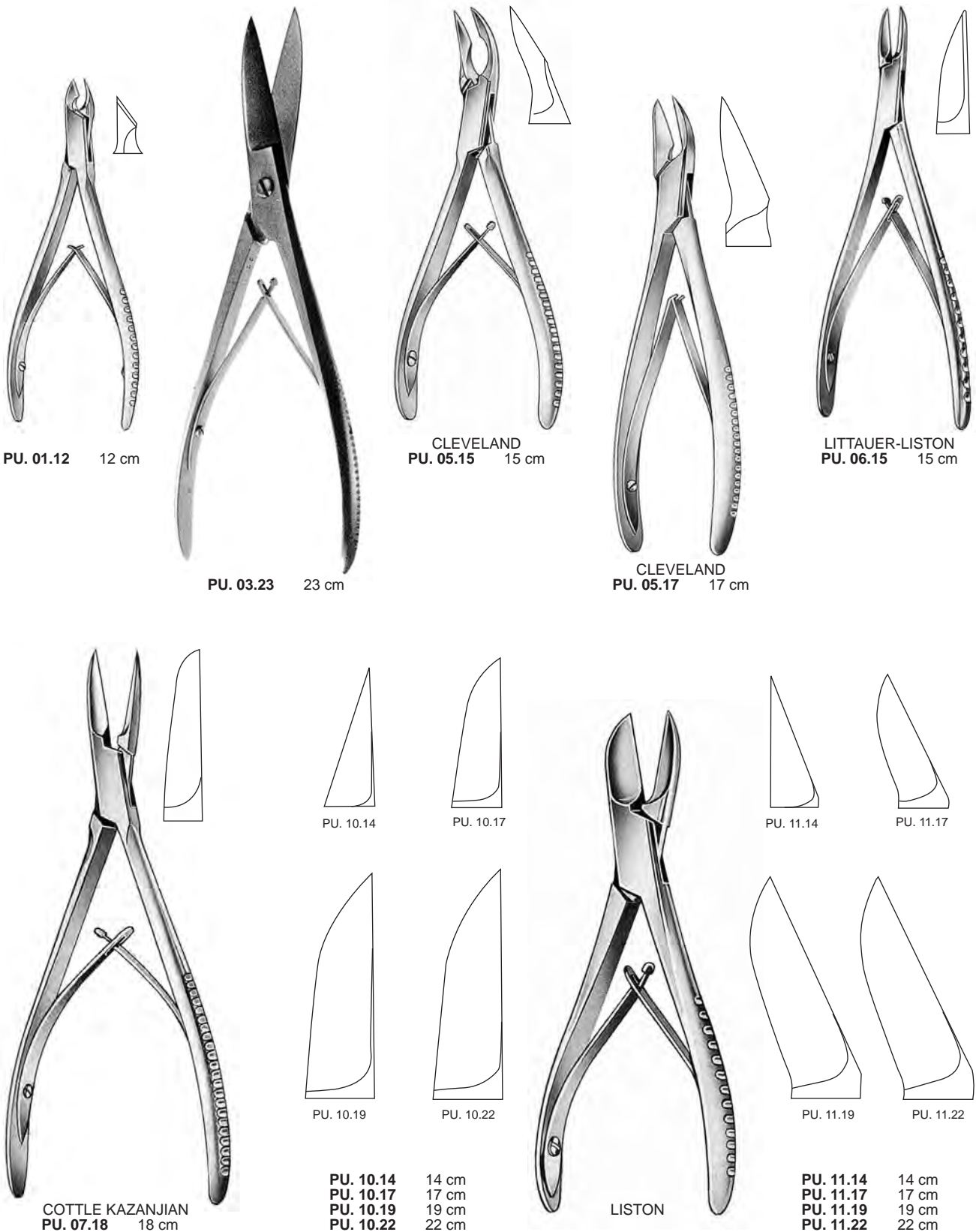

Bone cutting forceps

Knochensplitterzangen
 Pinzas cortantes para huesos
 Pincès coupantes

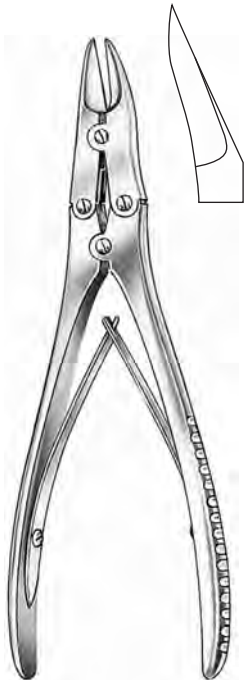

MCINDOE
 Straight PU. 15.18 17.5 cm Angled PU. 15.19

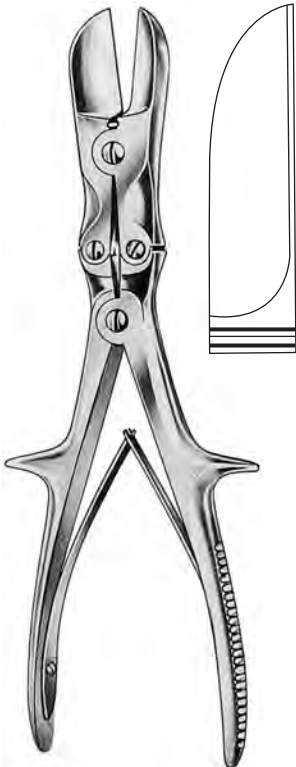

LISTON-STILLE
 PU. 17.27 27 cm

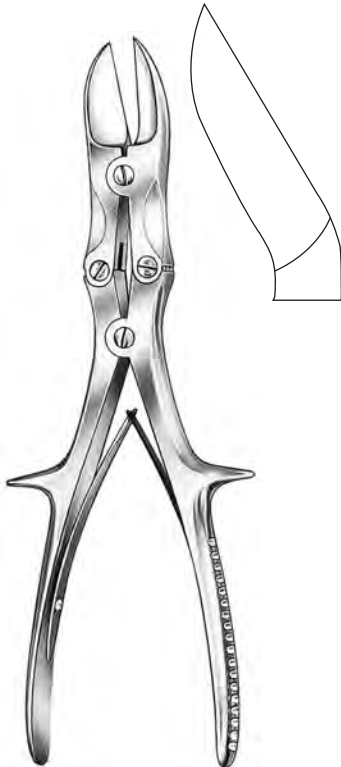

LISTON
 Straight PU. 18.24 17.5 cm Angled PU. 18.25

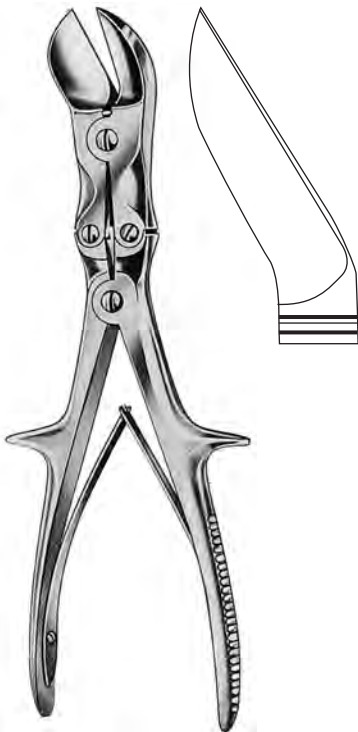

LISTON-STILLE
 PU. 18.27 27 cm

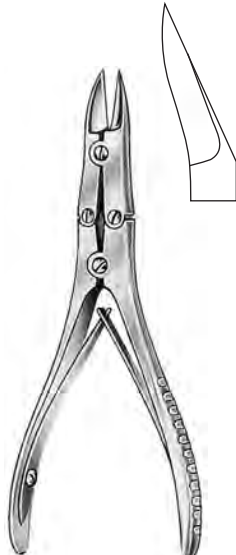

LISTON-MINI
 Straight PU. 20.15 15 cm Angled PU. 21.15

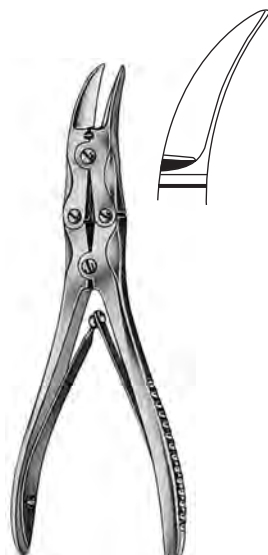

KLEINERT-KUTZ
 PU. 22.15 15 cm

Bone cutting forceps

Knochensplitterzangen

Pinzas cortantes para huesos

Pinces coupantes



RUSKIN-ROWLAND
PU. 23.18 18 cm



RUSKIN-ROWLAND
PU. 24.18 18 cm



RUSKIN-LISTON
PU. 25.18 18 cm



RUSKIN-LISTON
PU. 26.18 18 cm



LISTON-KEY
(HORSLEY-STILLE)
PU. 28.27 27 cm



SEMB
PU. 29.23 23 cm

Surgical-i

Precision | Performance | Innovation

Bone holding forceps & clamps
 Knochenhaltezangen & -klammern
 Pinzas para huesos y porte huesos
 Daviers

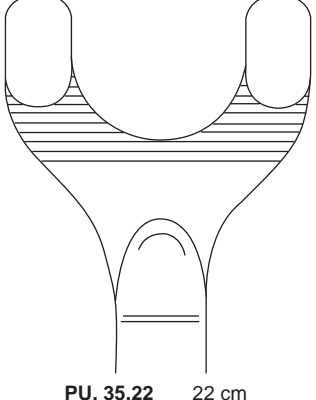
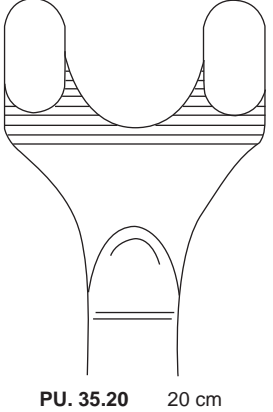
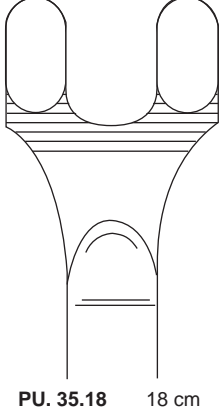
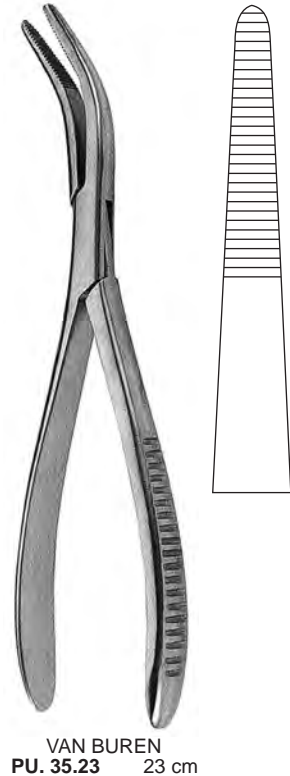
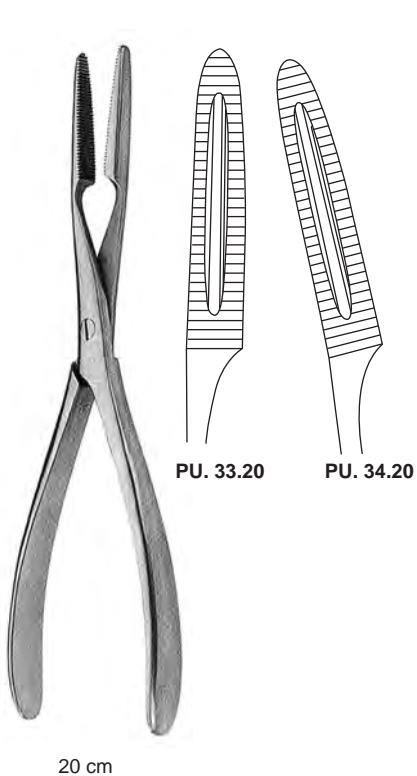

Bone holding forceps

Knochenhaltezaugen

Pinzas para huesos

Daviers

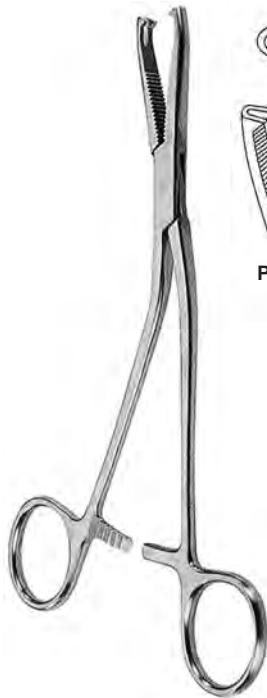

DINGMANN
19 cm



PU. 38.19



PU. 39.19



PU. 40.21 21 cm

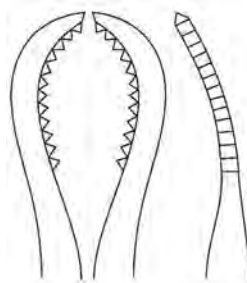

PU. 41.16 16 cm

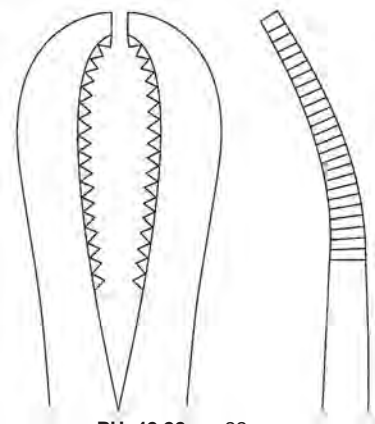

PU. 42.22 22 cm

Bone holding forceps

Knochenhaltezangen

Pinzas para huesos

Daviers



SEMB
PU. 43.20 20 cm



SEMB
PU. 44.20 20 cm



PU. 46.14 13.5 cm



PU. 31.13 13.5 cm



LEWIN
PU. 48.18 17.5 cm



MARTIN
PU. 50.19 19 cm



LANGENBECK
PU. 51.21 21 cm

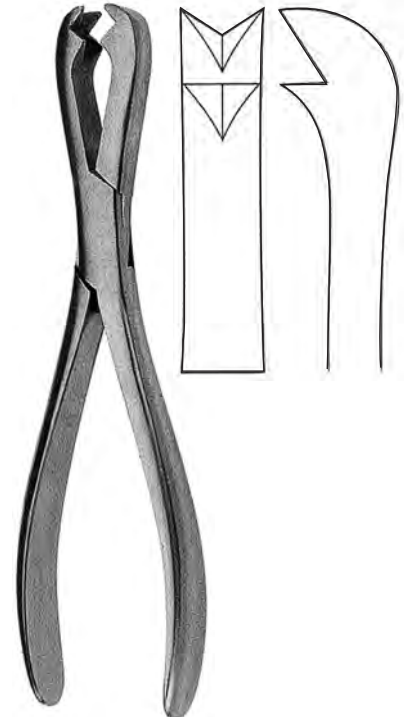

FERGUSSON
PU. 52.21 21 cm

Bone holding forceps

Knochenhaltezangen

Pinzas para huesos

Daviers

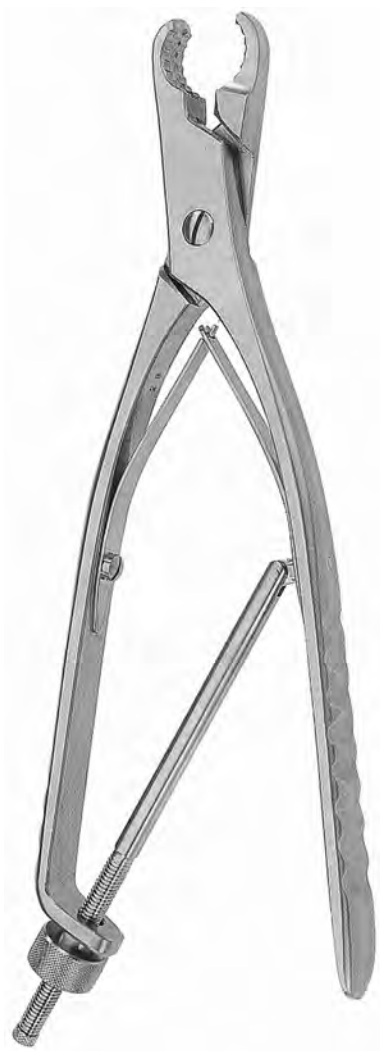

ULRICH
PU. 55.23
PU. 55.25
PU. 55.28



PU. 55.23
PU. 55.24
23 cm

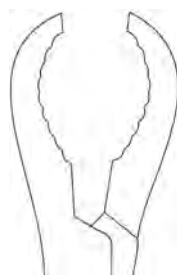

PU. 55.25
PU. 55.26
25 cm

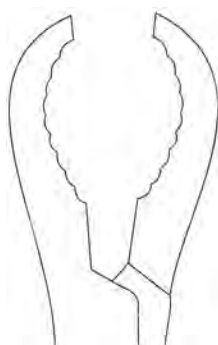

PU. 55.28
PU. 55.29
28 cm



ULRICH
PU. 55.24
PU. 55.26
PU. 55.29

Bone holding forceps

Knochenhaltezangen

Pinzas para huesos

Daviers



KERN
PU. 56.14 14 cm
PU. 56.17 17 cm
PU. 61.23 23 cm



KERN
PU. 57.14 14 cm
PU. 57.17 17 cm
PU. 60.23 23 cm



LANE
 Without Ratchet **PU. 58.33** 33 cm
 With Ratchet **PU. 59.33** 33 cm
PU. 58.45 45 cm **PU. 59.45** 45 cm



LAMBOTTE
PU. 62.21 21 cm
PU. 62.25 25 cm
PU. 62.30 30 cm

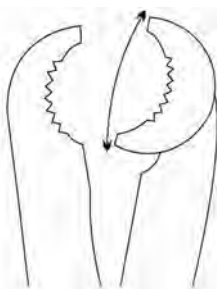

LAMBOTTE
PU. 63.21 21 cm
PU. 63.26 26 cm
PU. 63.33 30 cm

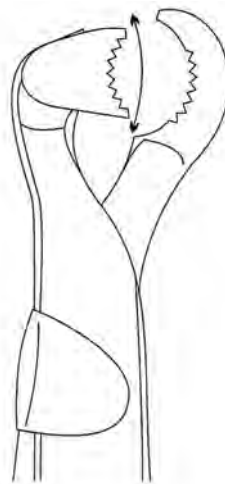

FARABEUF
PU. 64.25 25 cm



FARABEUF-LAMBOTTE
PU. 65.26 26 cm

Bone holding forceps

Knochenhalte­zangen

Pinzas para huesos

Daviers



VERBRUGGE

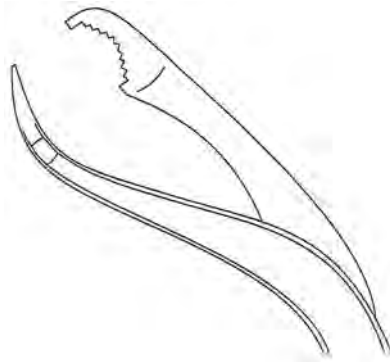

PU. 66.17 17.5 cm

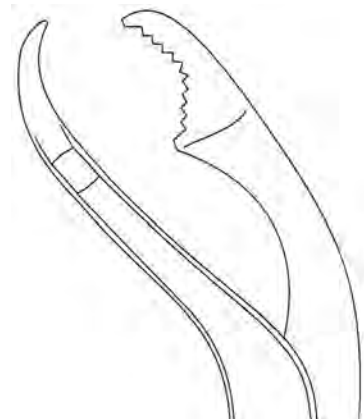

PU. 67.25 25 cm

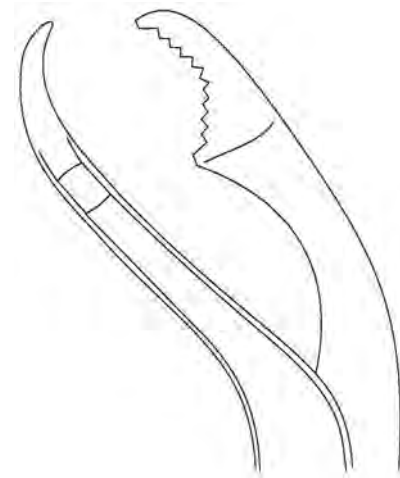

PU. 67.26 26 cm

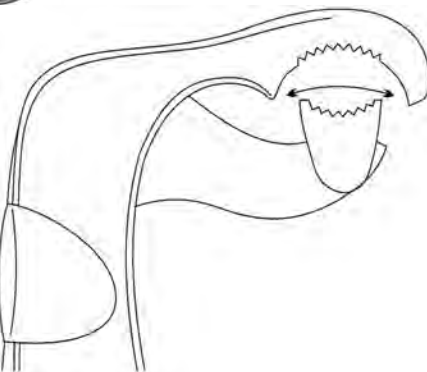
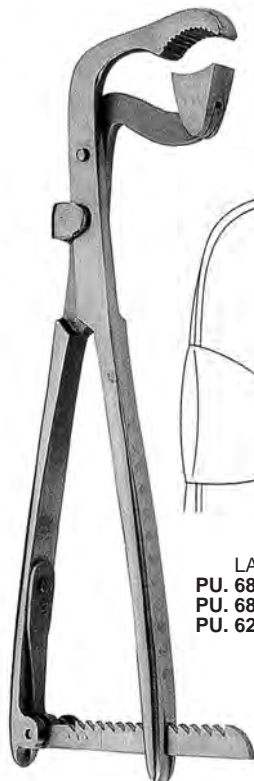

LAMBOTTE
PU. 68.19 19 cm
PU. 68.23 23 cm
PU. 62.26 26 cm

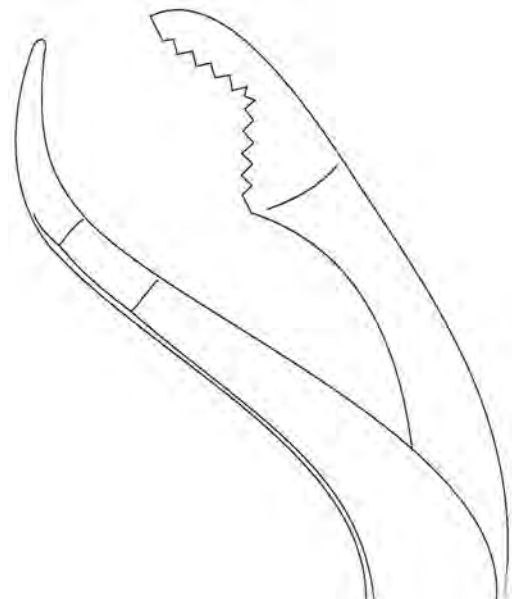

PU. 67.27 27 cm

Bone holding forceps

Knochenhaltezaugen

Pinzas para huesos

Daviers



PU. 69.15 15 cm

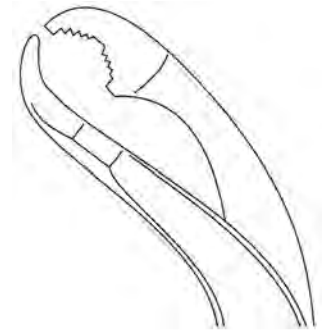

PU. 69.19 19 cm



PU. 69.24 24 cm

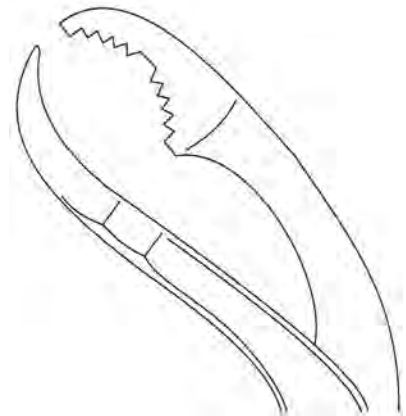

PU. 69.26 26 cm

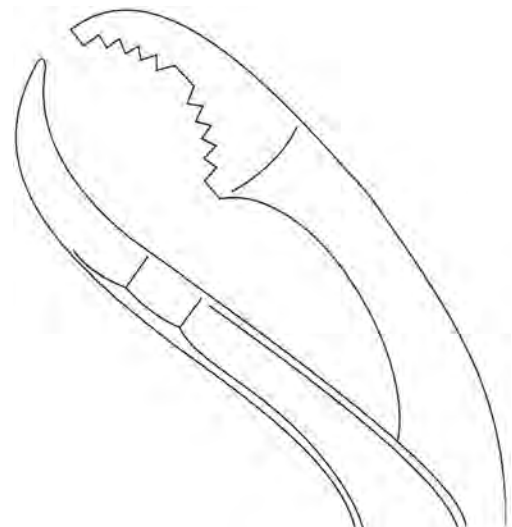

PU. 69.28 28 cm



Amputating & resection saws

Amputations- & Resektionssägen
Sierras para amputación y resección
Scies à amputation et résection



LANGENBECK
PU. 70.30 23 cm



CHARRIERE
PU. 71.27 27 cm
PU. 71.30 30 cm
PU. 71.34 34 cm



SATTERLEE
PU. 72.29 31 cm



CHARRIERE
PU. 73.35 35 cm

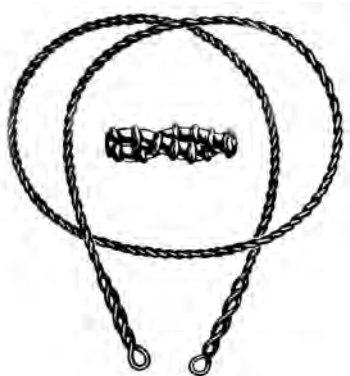

GIGLI
PU. 74.30 30 cm
PU. 74.40 40 cm
PU. 74.50 50 cm
PU. 74.60 60 cm
PU. 74.70 70 cm



GIGLI
PU. 74.02

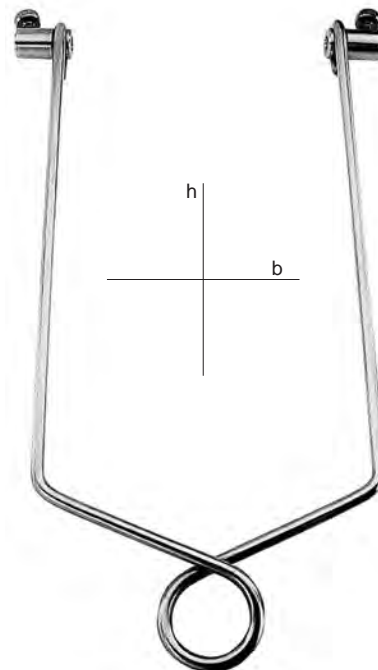

BÖHLER
h x b
PU. 76.01 16 x 9 cm
PU. 76.03 21 x 11 cm
PU. 76.05 21 x 15 cm

Wire forceps

Drahtzangen
Pinzas para hilos
Pincas à fil



PU. 80.01 PU. 80.02

17 cm

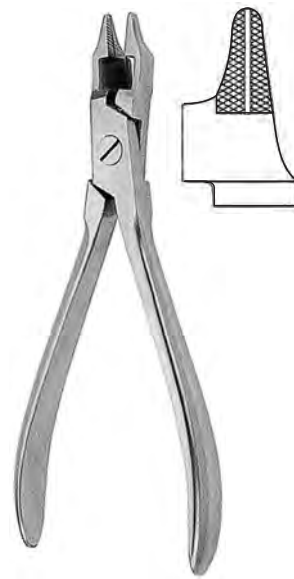

PU. 82.15
15 cm

Flat nose pliers, Wire twisting instruments

Flachzangen, Drahtspanninstrumente
Alicates planos, Tensores cierra-hilos
Pincas plates, Tendeurs sèrre-fils

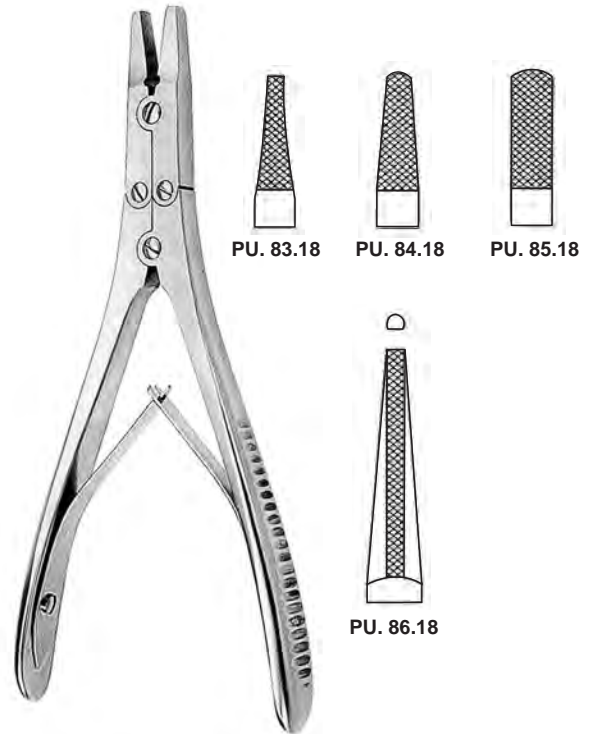

PU. 83.18 PU. 84.18 PU. 85.18

PU. 86.18

18 cm

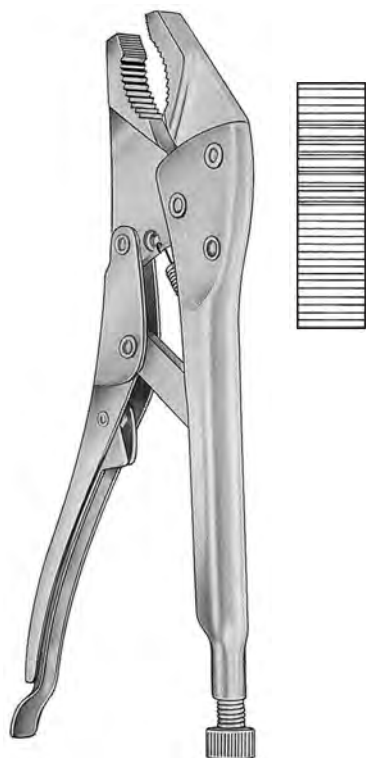

PU. 88.18 18 cm

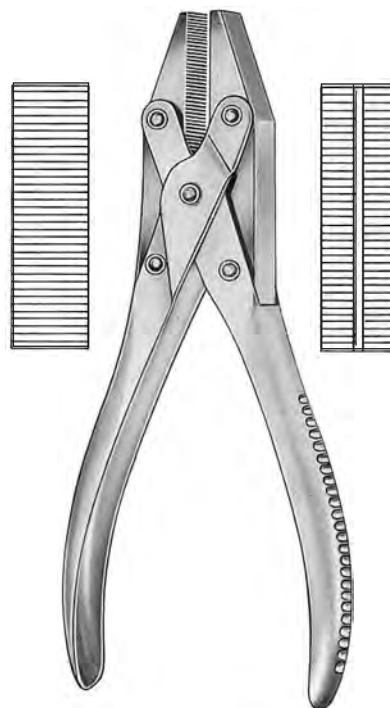

PU. 89.17 17 cm



LOUTE
PU. 90.21 21 cm

Wire cutting pliers

Drahtkneifzangen
Alicates cortaalambres
Pincès coupe-fil

Wire cutting pliers, PROLONG TC®

Drahtkneifzangen, PROLONG TC®
Alicates cortaalambres, PROLONG TC®
Pincès coupe-fil, PROLONG TC®

Scissors with tungsten carbide cutting edges

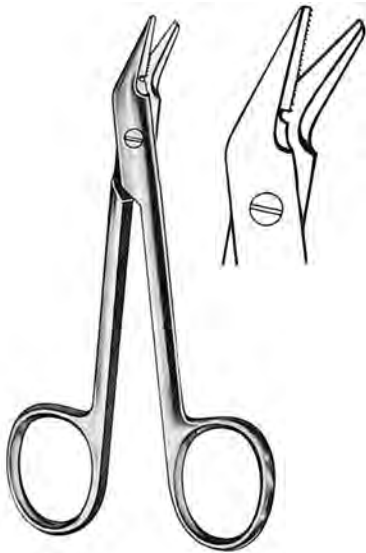

UNIVERSAL
PS. 23.12 12 cm

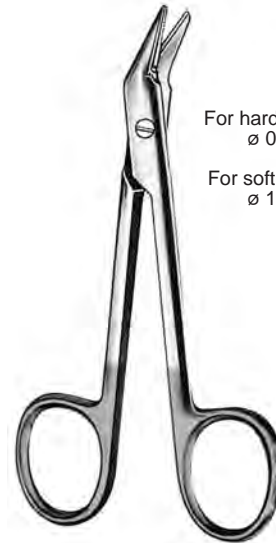

For hard wires upto
ø 0.8 mm
For soft wires upto
ø 1.2 mm

UNIVERSAL
PS. 24.12 12 cm

Pliers with tungsten carbide cutting edges



PU. 91.15 15 cm



PU. 92.16 16 cm

For hard wires upto
ø 1.5 mm
For soft wires upto
ø 2.0 mm

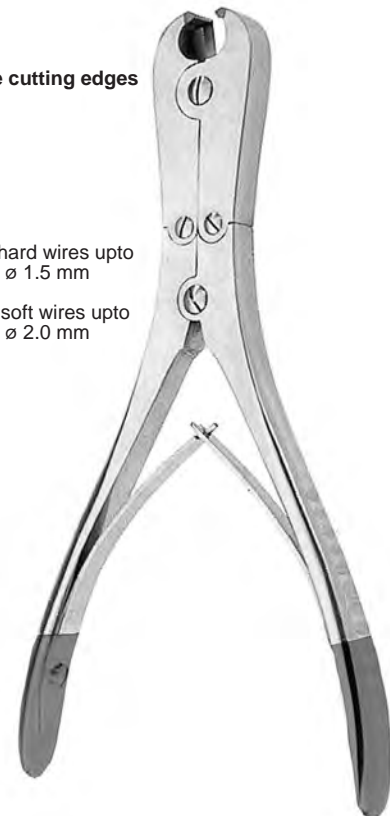

PU. 94.18 18 cm

Wire cutting pliers, PROLONG TC®
Drahtkneifzangen, **PROLONG TC®**
Alicates cortaambres, **PROLONG TC®**
Pincas coupe-fil, **PROLONG TC®**

Pliers with tungsten carbide cutting edges

PU. 100.47
For cutting off
KIRCHNER wires,
TIBIA head screw,
bolts, pins upto
ø 6.0 mm

PU. 100.56
PROLONG TC®
For hard wires upto
ø 2.5 mm

For hard wires upto
ø 1.6 mm

For soft wires upto
ø 2.0 mm



PU. 96.17 17 cm

For hard wires upto
ø 2.5 mm



PU. 98.22 22 cm



MEGA CUT
PU. 100.47 47 cm
PU. 100.56 56 cm

Chisels & Gouges

Flach- & Hohlmeißel

Cinceles y Gubias

Ciseaux-burins et Gouges



MINI-LAMBOTTE
13 cm

| | |
|-----------|-------|
| PV. 01.02 | 2 mm |
| PV. 01.04 | 4 mm |
| PV. 01.06 | 6 mm |
| PV. 01.08 | 8 mm |
| PV. 01.10 | 10 mm |
| PV. 01.12 | 12 mm |
| PV. 01.15 | 15 mm |



TRAUTMANN
11 cm

| | |
|-----------|-------|
| PV. 04.12 | 2 mm |
| PV. 04.14 | 4 mm |
| PV. 04.16 | 6 mm |
| PV. 04.18 | 8 mm |
| PV. 04.20 | 10 mm |



TRAUTMANN
11 cm

| | |
|-----------|-------|
| PV. 04.72 | 2 mm |
| PV. 04.74 | 4 mm |
| PV. 04.76 | 6 mm |
| PV. 04.78 | 8 mm |
| PV. 04.80 | 10 mm |



13.5 cm

| | |
|-----------|--|
| PV. 05.02 | |
| PV. 05.03 | |
| PV. 05.04 | |
| PV. 05.05 | |
| PV. 05.06 | |
| PV. 05.07 | |
| PV. 05.08 | |

17 cm

| | |
|-----------|------|
| PV. 05.52 | 2 mm |
| PV. 05.53 | 3 mm |
| PV. 05.54 | 4 mm |
| PV. 05.55 | 5 mm |
| PV. 05.56 | 6 mm |
| PV. 05.57 | 7 mm |
| PV. 05.58 | 8 mm |



13.5 cm

| | |
|-----------|-----------|
| PV. 06.02 | PV. 06.52 |
| PV. 06.03 | PV. 06.53 |
| PV. 06.04 | PV. 06.54 |
| PV. 06.05 | PV. 06.55 |
| PV. 06.06 | PV. 06.56 |
| PV. 06.07 | PV. 06.57 |
| PV. 06.08 | PV. 06.58 |

17 cm



HOKE
14 cm

| | |
|-----------|-------|
| PV. 13.03 | 3 mm |
| PV. 13.04 | 5 mm |
| PV. 13.06 | 6 mm |
| PV. 13.08 | 8 mm |
| PV. 13.10 | 10 mm |
| PV. 13.12 | 12 mm |



| | |
|-----------|-------|
| PV. 11.06 | 6 mm |
| PV. 11.08 | 8 mm |
| PV. 11.10 | 10 mm |
| PV. 11.12 | 12 mm |
| PV. 11.15 | 15 mm |
| PV. 11.20 | 20 mm |
| PV. 11.25 | 25 mm |
| PV. 11.30 | 30 mm |



| | |
|-----------|-------|
| PV. 12.06 | 6 mm |
| PV. 12.08 | 8 mm |
| PV. 12.10 | 10 mm |
| PV. 12.12 | 12 mm |
| PV. 12.15 | 15 mm |
| PV. 12.20 | 20 mm |
| PV. 12.25 | 25 mm |
| PV. 12.30 | 30 mm |



STILLE
20 cm

| | |
|-----------|-------|
| PV. 16.08 | 8 mm |
| PV. 16.10 | 10 mm |
| PV. 16.12 | 12 mm |
| PV. 16.15 | 15 mm |
| PV. 16.20 | 20 mm |
| PV. 16.25 | 25 mm |



| | |
|-----------|-------|
| PV. 16.58 | 8 mm |
| PV. 16.60 | 10 mm |
| PV. 16.62 | 12 mm |
| PV. 16.65 | 15 mm |
| PV. 16.70 | 20 mm |
| PV. 16.75 | 25 mm |

Chisels, Gouges and Osteotomes

Meißel und Osteotome

Cinceles, Gubias, Osteótomos

Ciseaux-Burins, Cinceles y Osteótomos



ALEXANDER
18 cm

| | |
|-----------|-------|
| PV. 17.04 | 4 mm |
| PV. 17.06 | 6 mm |
| PV. 17.08 | 8 mm |
| PV. 17.10 | 10 mm |
| PV. 17.12 | 12 mm |
| PV. 17.14 | 14 mm |



ALEXANDER
18 cm

| | |
|-----------|-------|
| PV. 18.04 | 4 mm |
| PV. 18.06 | 6 mm |
| PV. 18.08 | 8 mm |
| PV. 18.10 | 10 mm |
| PV. 18.12 | 12 mm |
| PV. 18.14 | 14 mm |



STILLE
16 cm

| | |
|-----------|-------|
| PV. 19.06 | 6 mm |
| PV. 19.08 | 8 mm |
| PV. 19.10 | 10 mm |
| PV. 19.12 | 12 mm |
| PV. 19.15 | 15 mm |



STILLE
16 cm

| | |
|-----------|-------|
| PV. 20.04 | 4 mm |
| PV. 20.06 | 6 mm |
| PV. 20.08 | 8 mm |
| PV. 20.10 | 10 mm |
| PV. 20.12 | 12 mm |
| PV. 20.15 | 15 mm |



13.5 cm

| | |
|-----------|-------|
| PV. 23.03 | 3 mm |
| PV. 23.04 | 4 mm |
| PV. 23.06 | 6 mm |
| PV. 23.08 | 8 mm |
| PV. 23.10 | 10 mm |
| PV. 23.12 | 12 mm |
| PV. 23.14 | 14 mm |
| PV. 23.16 | 16 mm |



13.5 cm

| | |
|-----------|-------|
| PV. 24.03 | 3 mm |
| PV. 24.04 | 4 mm |
| PV. 24.06 | 6 mm |
| PV. 24.08 | 8 mm |
| PV. 24.10 | 10 mm |
| PV. 24.12 | 12 mm |
| PV. 24.14 | 14 mm |
| PV. 24.16 | 16 mm |



13.5 cm

| | |
|-----------|-------|
| PV. 25.04 | 4 mm |
| PV. 25.06 | 6 mm |
| PV. 25.08 | 8 mm |
| PV. 25.10 | 10 mm |
| PV. 25.12 | 12 mm |
| PV. 25.14 | 14 mm |
| PV. 25.16 | 16 mm |

Chisels, Gouges and Osteotomes

Meißel und Osteotome

Cinceles, Gubias y Osteótomos

Ciseaux-Burins, Gouges et Ostéotomes



HIBBS
24 cm

| | |
|-----------|-------|
| PV. 30.06 | 6 mm |
| PV. 30.13 | 13 mm |
| PV. 30.19 | 19 mm |
| PV. 30.25 | 25 mm |
| PV. 30.32 | 32 mm |
| PV. 30.40 | 40 mm |



HIBBS
24 cm

| | |
|-----------|-------|
| PV. 31.06 | 6 mm |
| PV. 31.13 | 13 mm |
| PV. 31.19 | 19 mm |
| PV. 31.25 | 25 mm |
| PV. 31.32 | 32 mm |
| PV. 31.40 | 40 mm |



HIBBS
24 cm

| | |
|-----------|-------|
| PV. 32.06 | 6 mm |
| PV. 32.13 | 13 mm |
| PV. 32.19 | 19 mm |
| PV. 32.25 | 25 mm |
| PV. 32.32 | 32 mm |
| PV. 32.40 | 40 mm |



HIBBS
24 cm

| | |
|-----------|-------|
| PV. 33.06 | 6 mm |
| PV. 33.13 | 13 mm |
| PV. 33.19 | 19 mm |
| PV. 33.25 | 25 mm |
| PV. 33.32 | 32 mm |
| PV. 33.40 | 40 mm |



HIBBS
24 cm

| | |
|-----------|-------|
| PV. 33.56 | 6 mm |
| PV. 33.53 | 13 mm |
| PV. 33.59 | 19 mm |
| PV. 33.65 | 25 mm |
| PV. 33.72 | 32 mm |
| PV. 33.80 | 40 mm |



LUCAS
16 cm

| | |
|-----------|-------|
| PV. 35.04 | 4 mm |
| PV. 35.06 | 6 mm |
| PV. 35.08 | 8 mm |
| PV. 35.10 | 10 mm |



LUCAS
16 cm

| | |
|-----------|-------|
| PV. 35.34 | 4 mm |
| PV. 35.36 | 6 mm |
| PV. 35.38 | 8 mm |
| PV. 35.40 | 10 mm |

Gouges

Hohlmeißel

Gubias

Gouges



COBB
PV. 36.91 28 cm



COBB
PV. 36.92 28 cm



COBB
PV. 36.93 28 cm



COBB
PV. 36.94 28 cm



LEXER
25 cm
PV. 36.55 5 mm
PV. 36.60 10 mm
PV. 36.65 15 mm



LEXER
25 cm
PV. 36.75 5 mm
PV. 36.80 10 mm
PV. 36.85 15 mm

Chisels & Gouges

Flach- & Hohlmeißel

Cinceles y Gubias

Ciseaux-burins et Gouges



PV. 38.06 6 mm
 PV. 38.09 9 mm
 PV. 38.12 12 mm
 PV. 38.14 14 mm
 PV. 38.15 15 mm
 PV. 38.20 20 mm
 PV. 38.25 25 mm
 PV. 38.30 30 mm



PV. 38.56 6 mm
 PV. 38.59 9 mm
 PV. 38.62 12 mm
 PV. 38.64 14 mm
 PV. 38.65 15 mm
 PV. 38.70 20 mm
 PV. 38.75 25 mm
 PV. 38.82 30 mm



PV. 40.06 6 mm
 PV. 40.09 9 mm
 PV. 40.12 12 mm
 PV. 40.15 15 mm
 PV. 40.16 16 mm
 PV. 40.17 17 mm
 PV. 40.20 20 mm
 PV. 40.25 25 mm
 PV. 40.30 30 mm



PV. 40.56 6 mm
 PV. 40.59 9 mm
 PV. 40.62 12 mm
 PV. 40.64 14 mm
 PV. 40.65 15 mm
 PV. 40.66 16 mm
 PV. 40.70 20 mm
 PV. 40.75 25 mm
 PV. 40.80 30 mm

SMITH-PETERSEN
20 cm



LAMBOTTE
24 cm

PV. 39.04 4 mm
 PV. 39.06 6 mm
 PV. 39.08 8 mm
 PV. 39.10 10 mm
 PV. 39.12 12 mm
 PV. 39.15 15 mm
 PV. 39.20 20 mm
 PV. 39.25 25 mm
 PV. 39.30 30 mm
 PV. 39.38 38 mm
 PV. 39.40 40 mm
 PV. 39.44 44 mm
 PV. 39.50 50 mm



LAMBOTTE
24 cm

PV. 39.54 4 mm
 PV. 39.56 6 mm
 PV. 39.58 8 mm
 PV. 39.60 10 mm
 PV. 39.62 12 mm
 PV. 39.65 15 mm
 PV. 39.70 20 mm
 PV. 39.75 25 mm
 PV. 39.80 30 mm
 PV. 39.88 38 mm
 PV. 39.90 40 mm
 PV. 39.94 44 mm
 PV. 39.99 50 mm

Chisels & Gouges

Flach- & Hohlmeißel

Cinceles y Gubias

Ciseaux-burins et Gouges



DAHMEN
30 cm

4 mm
5 mm
6 mm
8 mm
10 mm
12 mm
15 mm
20 mm
22 mm
25 mm



PV. 45.04
PV. 45.05
PV. 45.06
PV. 45.08
PV. 45.10
PV. 45.12
PV. 45.15
PV. 45.20
PV. 45.22
PV. 45.25

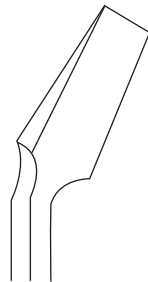

PV. 46.04
PV. 46.05
PV. 46.06
PV. 46.08
PV. 46.10
PV. 46.12
PV. 46.15
PV. 46.20
PV. 46.22
PV. 46.25



PV. 47.04
PV. 47.05
PV. 47.06
PV. 47.08
PV. 47.10
PV. 47.12
PV. 47.15
PV. 47.20
PV. 47.22
PV. 47.25

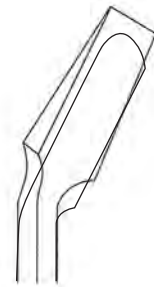

PV. 48.04
PV. 48.05
PV. 48.06
PV. 48.08
PV. 48.10
PV. 48.12
PV. 48.15
PV. 48.20
PV. 48.22
PV. 48.25



LEXER
27.5 cm

PV. 50.10 10 mm
PV. 50.15 15 mm



LEXER
27.5 cm

PV. 52.10 10 mm
PV. 52.15 15 mm

Chisels, Gouges and Osteotomes

Meißel und Osteotome

Cinceles y Gubias

Ciseaux-Burins et Ostéotomes

Meniscotomy knives

Meniskotome

Bisturies para meniscos

Bistouris à ménisques



MINI-LEXER
18 cm

- PV. 54.04 4 mm
- PV. 54.06 6 mm
- PV. 54.08 8 mm
- PV. 54.10 10 mm
- PV. 54.12 12 mm
- PV. 54.15 15 mm
- PV. 54.20 20 mm



MINI-LEXER
18 cm

- PV. 56.04 4 mm
- PV. 56.06 6 mm
- PV. 56.08 8 mm
- PV. 56.10 10 mm
- PV. 56.12 12 mm
- PV. 56.15 15 mm
- PV. 56.20 20 mm



LEXER
22 cm

- PV. 58.07 7 mm
- PV. 58.10 10 mm
- PV. 58.15 15 mm
- PV. 58.20 20 mm
- PV. 58.25 25 mm
- PV. 58.30 30 mm



LEXER
22 cm

- PV. 60.07 7 mm
- PV. 60.10 10 mm
- PV. 60.15 15 mm
- PV. 60.20 20 mm
- PV. 60.25 25 mm
- PV. 60.30 30 mm



SMILLIE
17 cm



PV. 62.01

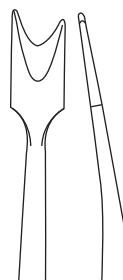

PV. 62.02

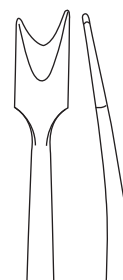

PV. 62.03

Bone curettes

Scharfe Löffel

Cucharillas cortantes

Curettes tranchantes



BRUNS
17 cm

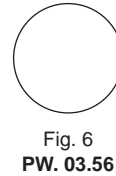
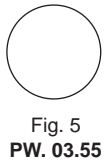
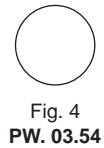
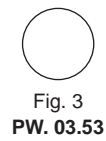
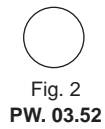
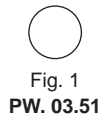
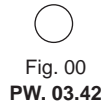
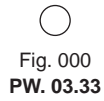

BRUNS
23 cm

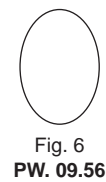
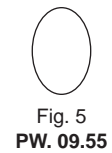
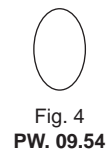
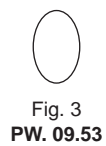
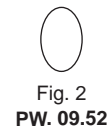
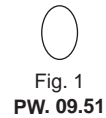
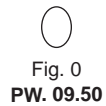
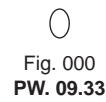
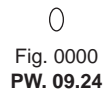

Bone curettes

Scharfe Löffel

Cucharillas cortantes

Curettes tranchantes



BRUNS
(VOLKMANN)
27 cm
Silver Handle

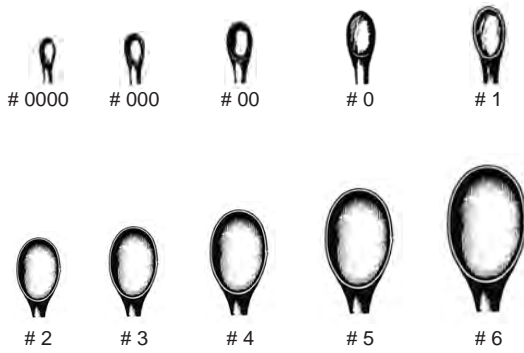

- PW. 10.24 # 0000
- PW. 10.33 # 000
- PW. 10.42 # 00
- PW. 10.50 # 0
- PW. 10.51 # 1
- PW. 10.52 # 2
- PW. 10.53 # 3
- PW. 10.54 # 4
- PW. 10.55 # 5
- PW. 10.56 # 6



SPRATT
17 cm

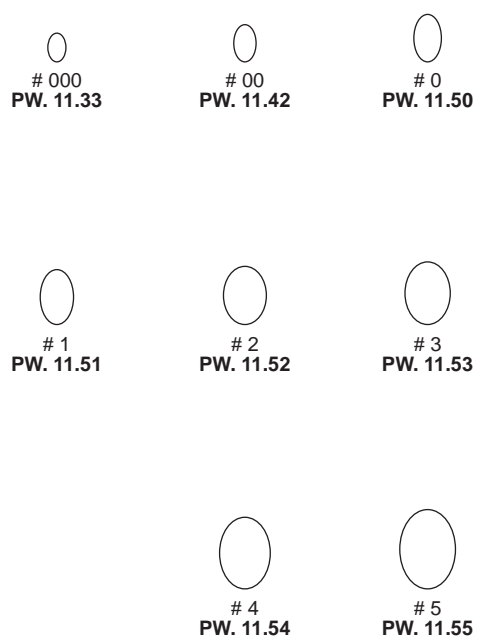

PW. 11.60 - PW. 11.68

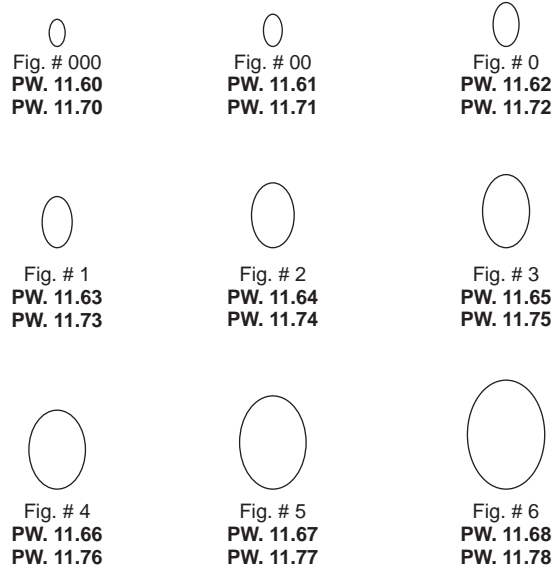

HIBBS SPRATT
SPINAL FUSION
25.5 cm



PW. 11.70 - PW. 11.78

Bone curettes

Scharfe Löffel

Cucharillas cortantes

Curettes tranchantes



HALLE
21 cm



Fig. # 1 - 4 mm
PW. 13.51



Fig. # 2 - 5 mm
PW. 13.52



Fig. # 3 - 6 mm
PW. 13.53



VOLKMANN
17 cm



Fig. # 0000
PW. 14.24



Fig. # 000
PW. 14.33



Fig. # 00
PW. 14.42



Fig. # 0
PW. 14.50



Fig. # 1
PW. 14.51



Fig. # 2
PW. 14.52



Fig. # 3
PW. 14.53



Fig. # 4
PW. 14.54

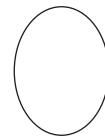

Fig. # 5
PW. 14.55



Fig. # 6
PW. 14.56



SCHEDE
17 cm



Fig. # 000
PW. 15.33



Fig. # 00
PW. 15.42



Fig. # 0
PW. 15.50



Fig. # 1
PW. 15.51



Fig. # 2
PW. 15.52



Fig. # 3
PW. 15.53



Fig. # 4
PW. 15.54

Bone curettes

Scharfe Löffel

Cucharillas cortantes

Curettes tranchantes



PW. 16.24 - PW. 16.56

Fig. # 0000
PW. 16.24
PW. 17.24

Fig. # 000
PW. 16.33
PW. 17.33

Fig. # 00
PW. 16.42
PW. 17.42

Fig. # 0
PW. 16.50
PW. 17.50

Fig. # 1
PW. 16.51
PW. 17.51

Fig. # 2
PW. 16.52
PW. 17.52

Fig. # 3
PW. 16.53
PW. 17.53

Fig. # 4
PW. 16.54
PW. 17.54

Fig. # 5
PW. 16.55
PW. 17.55

Fig. # 6
PW. 16.56
PW. 17.56

BRUNS-VOLKMANN
23 cm



PW. 17.24 - PW. 17.56



MARTINI
13.5 cm

PW. 18.10

PW. 18.11

PW. 18.12



JANSEN
PW. 19.62
17 cm



PW. 20.96
21 cm



WILLIGER
13.5 cm

PW. 21.10

PW. 21.11

PW. 21.12

Surgical-i

Precision | Performance | Innovation

Bone curettes
Scharfe Löffel
Cucharillas cortantes
Curettes tranchantes



JANSEN
PW. 23.72
17 cm



VOLKMANN

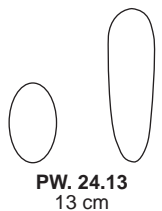

PW. 24.13
13 cm

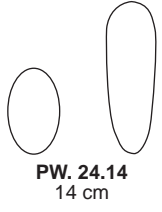

PW. 24.14
14 cm

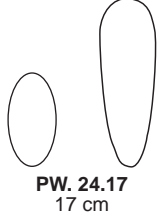

PW. 24.17
17 cm



VOLKMANN
22 cm

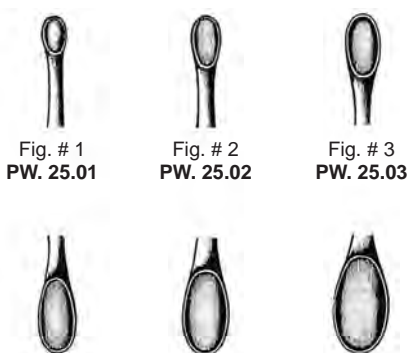
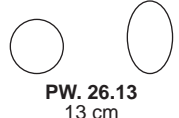

Fig. # 1
PW. 25.01

Fig. # 2
PW. 25.02

Fig. # 3
PW. 25.03



PW. 26.13
13 cm

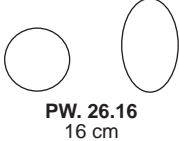

PW. 26.16
16 cm

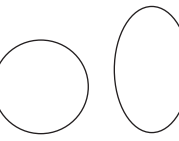

PW. 26.20
20 cm



VOLKMANN

Bone rongeurs
 Hohlmeißelzangen
 Pinzas Gubias
 Pincas gouges



MINI-FRIEDMAN
 PX. 01.12
 12 cm



FRIEDMAN
 PX. 01.14
 14 cm

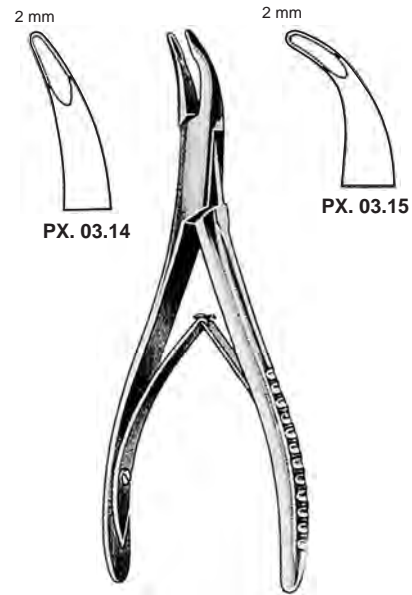

14 cm



UNIVERSAL
 PX. 03.84
 13 cm

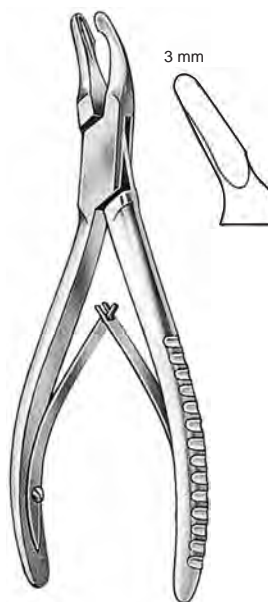

MEAD
 PX. 04.14
 14 cm

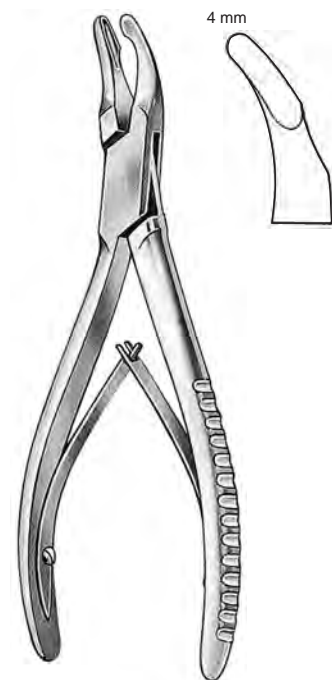

MEAD
 PX. 04.17
 17 cm

Surgical-i

Precision | Performance | Innovation

Bone rongeurs
Hohlmeißelzangen
Pinzas Gubias
Pincas gouges

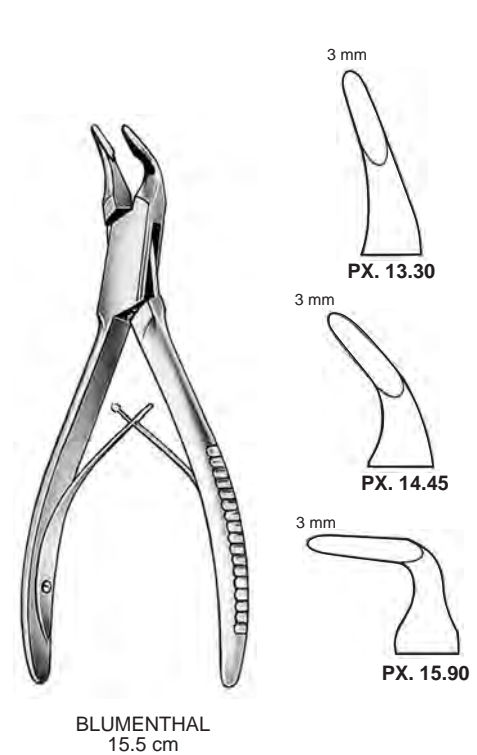
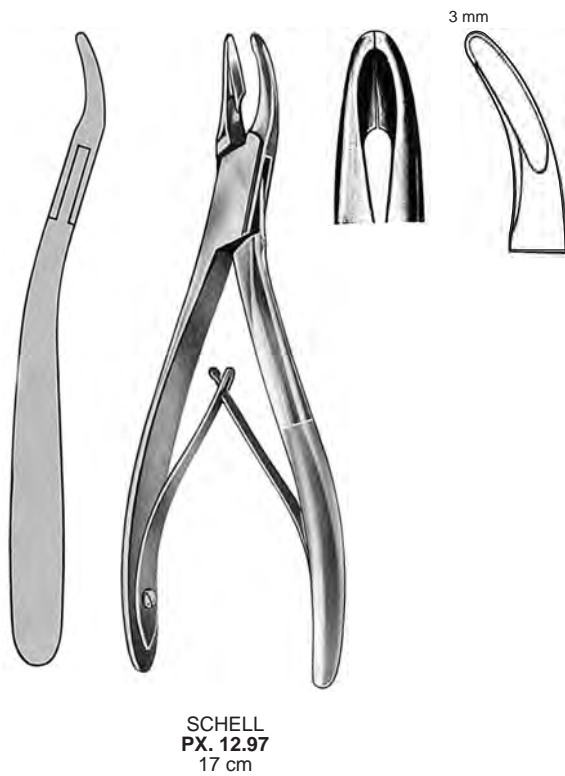
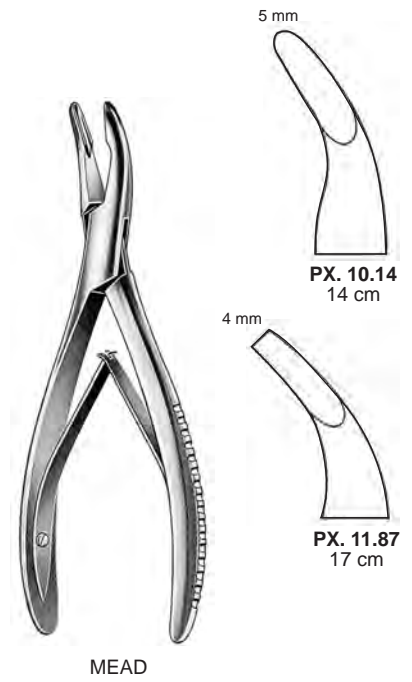
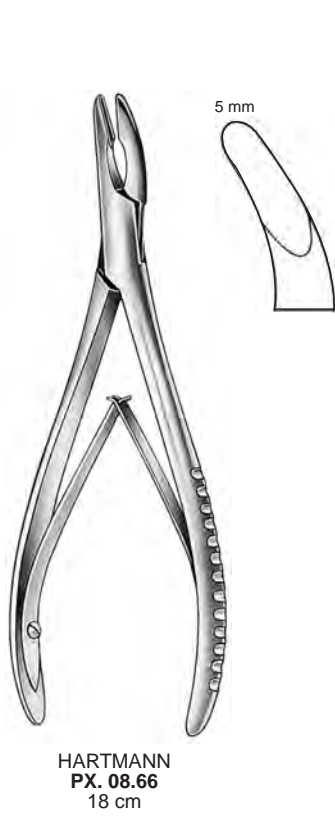

Bone rongeurs
 Hohlmeißelzangen
 Pinzas Gubias
 Pincas gouges

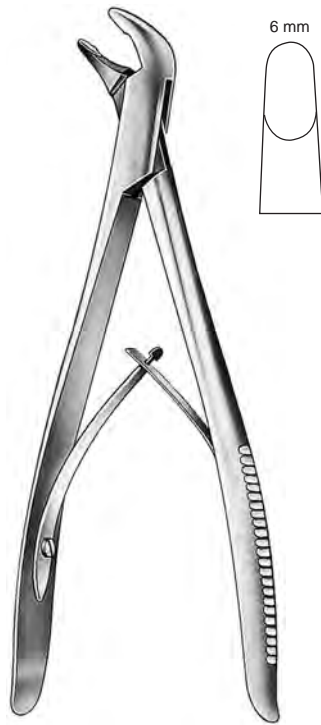

BACON
PX. 18.70
 20 cm



PX. 19.02

PX. 19.03

BEYER
 17 cm



PX. 20.55



PX. 20.65

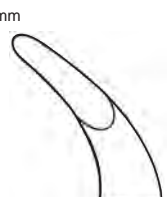

PX. 20.75

LUER
 15 cm



PX. 22.17



PX. 22.18

LUER
 18 cm

Bone rongeurs

Hohlmeißelzangen

Pinzas Gubias

Pincas gouges



LUER
PX. 23.18
18 cm



LUER
PX. 24.18
18 cm



KLEINERT-KUTZ
14 cm

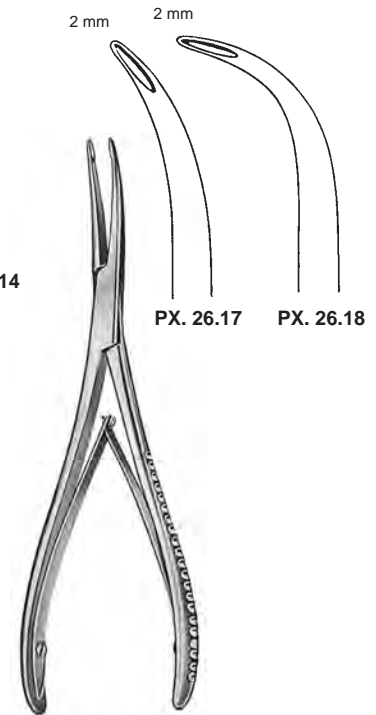

STELLBRINK
17 cm



RUSKIN
PX. 26.33
23 cm



SMITH-PETERSON
24 cm

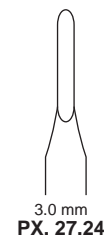

3.0 mm
PX. 27.24

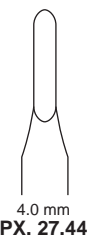

4.0 mm
PX. 27.44

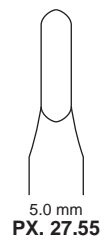

5.0 mm
PX. 27.55

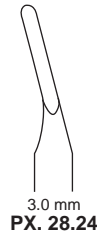

3.0 mm
PX. 28.24



4.0 mm
PX. 28.44

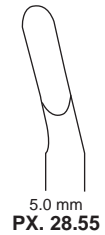

5.0 mm
PX. 28.55

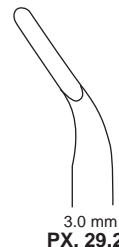

3.0 mm
PX. 29.24

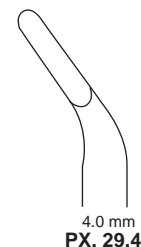

4.0 mm
PX. 29.44

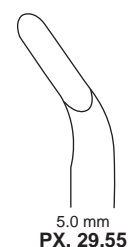

5.0 mm
PX. 29.55

Surgical-i

Precision | Performance | Innovation

Bone rongeurs
 Hohlmeißelzangen
 Pinzas Gubias
 Pincers gouges



ZAUFAL-JANSEN
PX. 30.18
 18 cm



BEYER
PX. 31.18
 18 cm

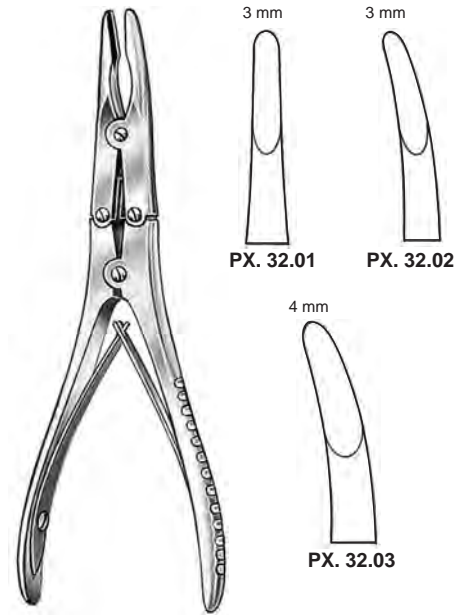

BÖHLER
 15 cm

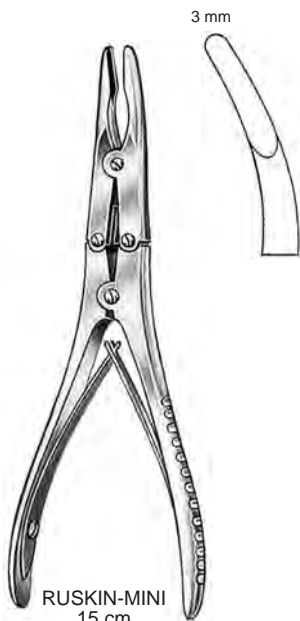

RUSKIN-MINI
 15 cm

| | | |
|------------------|------|------------------|
| <i>Straight</i> | | <i>Curved</i> |
| PX. 32.15 | 2 mm | PX. 33.15 |
| PX. 32.17 | 3 mm | PX. 33.17 |

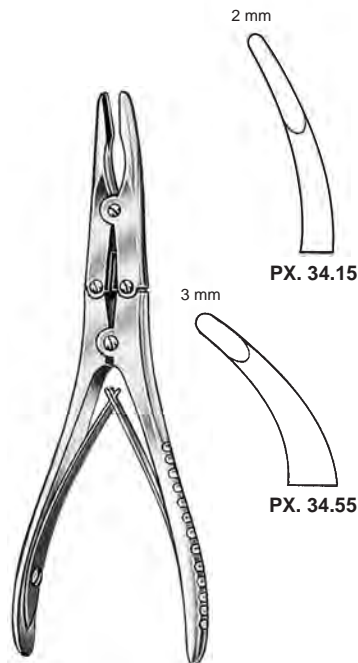

KLEINERT-KUTZ
 15 cm

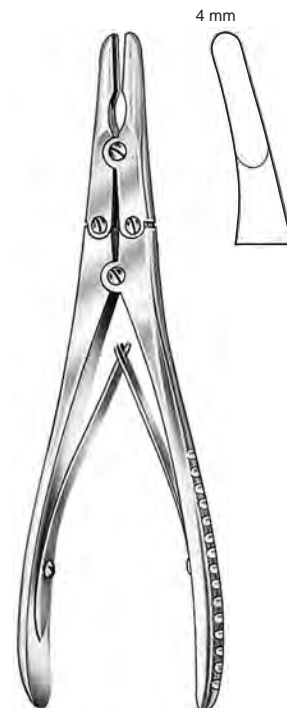

RUSKIN
PX. 34.18
 18 cm

Surgical-i

Precision | Performance | Innovation

Bone rongeurs

Hohlmeißelzangen

Pinzas Gubias

Pinces gouges

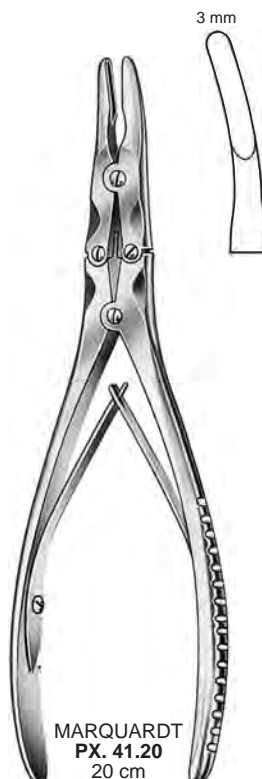
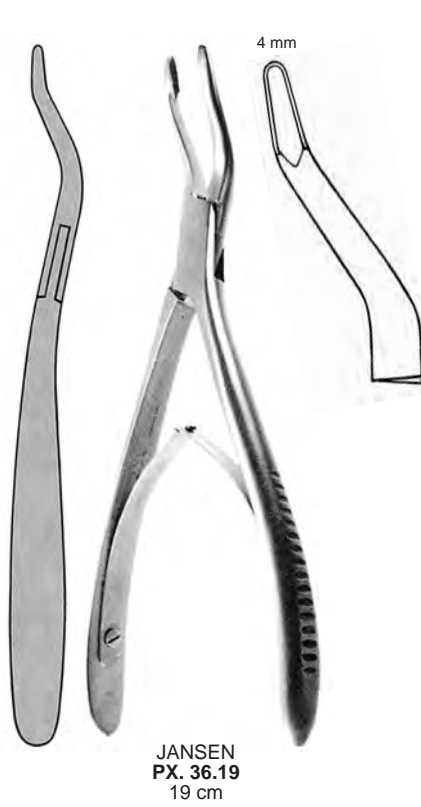

Bone rongeurs
 Hohlmeißelzangen
 Pinzas Gubias
 Pincas gouges

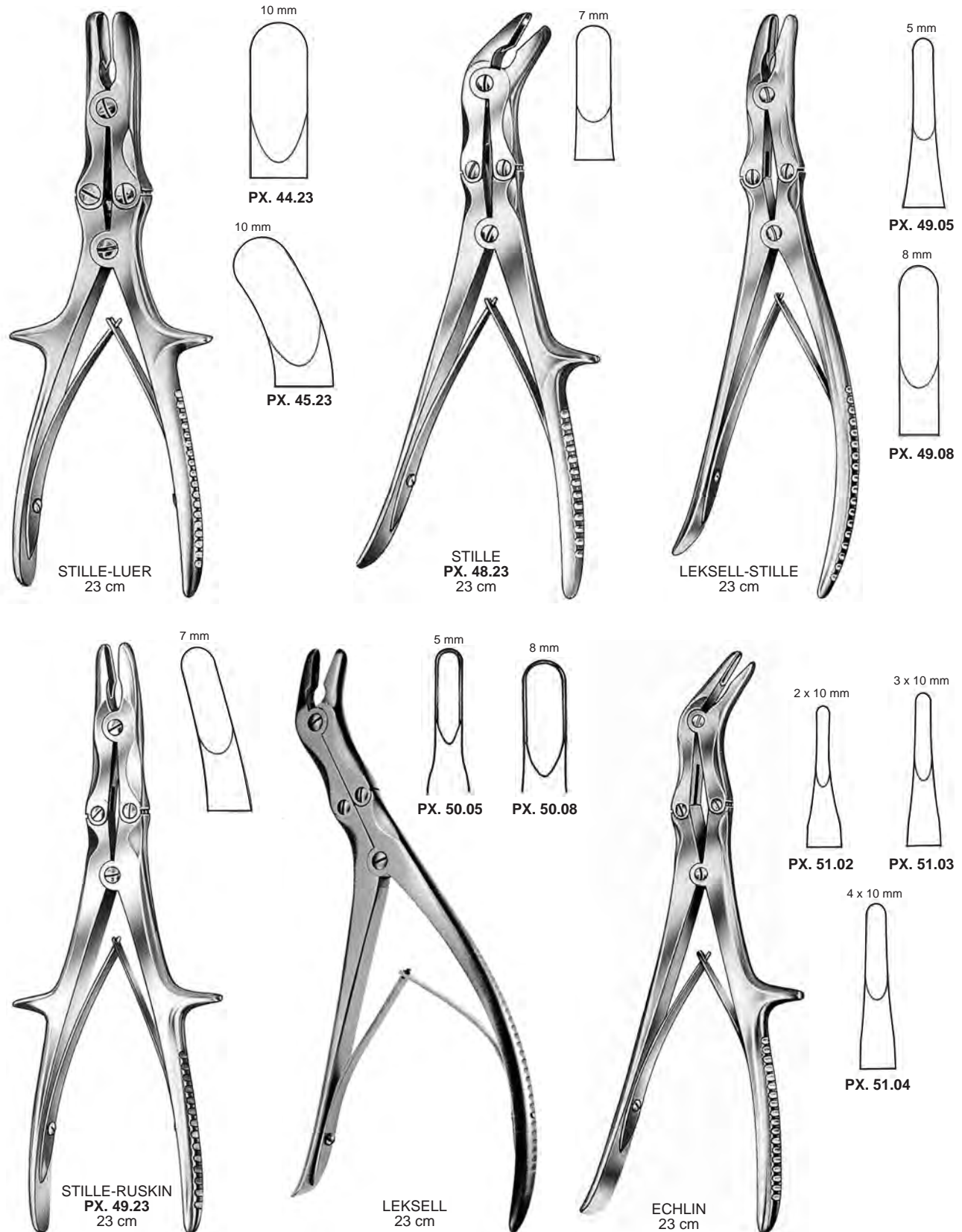

Surgical-i

Precision | Performance | Innovation

Bone rongeurs
 Hohlmeißelzangen
 Pinzas Gubias
 Pincas gouges

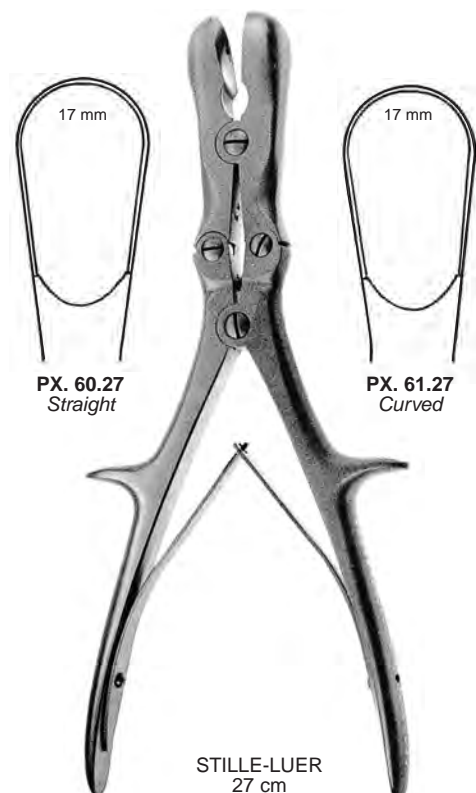
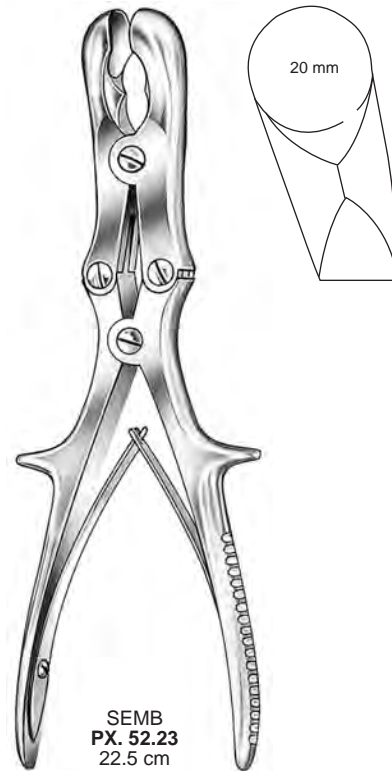

Hand bone drills

Handbohrapparate

Perforadores de mano para huesos

Perforateur à main

Finger ring saws and nail instruments

Fingerringsägen und Nagelzange

Sierras para abrir anillos y pinza para uñas

Scies pour bagues et pince à ongle



HUDSON
PAH. 53.00
27 cm
Complete with
PAH. 53.05 to PAH. 56.34



PAH. 53.05
10 cm



PAH. 54.00
ø 9 mm, 10 cm



PAH. 54.14
ø 14 mm, 10 cm



PAH. 55.16
ø 16 mm, 10 cm



PAH. 55.22
ø 22 mm, 10 cm



CUSHING
PAH. 56.34
ø 14 mm, 10 cm



WALTON
PAE. 03.00
16 cm



PAE. 04.00
17 cm



RADOLF
PAE. 15.15
13.5 cm

INDEX

| | | | | | |
|-------------------|-------------------------------|-------|-------------------|-------------------------------------|----------|
| ADSON | Dressing & Tissue Forceps | 7 | HALSTEAD-MOSQUITO | Hemostatic Forceps | 8 |
| ADSON | Dressing & Tissue Forceps, TC | 7 | HARTMANN | Bone Rongeur | 61 |
| ADSON | Elevators | 27 | HENNIG | Plaster Cast Breaker | 21 |
| ADSON | Haemostatic Forceps | 11 | HIBBS | Chisels & Gouges | 50 |
| ADSON | Laminectomy Retractors | 16 | HIBBS-SPRATT | Bone Curettes | 56 |
| ALDERDYCE | Elevators | 29 | HOEN | Elevators | 26 |
| ALEXANDER | Chisels & Gouges | 49 | HOHMANN | Bone Levers | 31,32 |
| BACKHAUS | Towel Clamps | 12 | HOKE | Chisels & Osteotomes | 48 |
| BACON | Bone Rongeur | 62 | HOPKINS | Plaster of Paris Knives | 21 |
| BECKMANN-ADSON | Laminectomy Retractors | 16 | HORSLEY-STILLE | Bone Cutting Forceps | 36 |
| BECKMANN-EATON | Laminectomy Retractors | 16 | HUDSON | Hand Drills | 68 |
| BEESON | Plaster Spreader | 21 | IRIS | Delicate Scissors | 3 |
| BERGMANN | Bandage Scissors | 20 | IRIS | Delicate Scissors, TC | 4 |
| BERGMANN | Mallets | 24 | JANSEN | Bone Curettes | 58,59 |
| BEYER | Bone Rongeur | 62,64 | JANSEN | Bone Rongeur | 65 |
| BLOUNT | Bone Lever | 32 | JANSEN | Retractors | 16 |
| BLOUNT | Knee Retractors | 33 | JOSEPH | Periosteal Elevators | 26 |
| BLUMENTHAL | Bone Rongeur | 61 | KERN | Bone Holding Forceps | 41 |
| BOHLER | Bone Rongeur | 64 | KIRK | Mallet | 22 |
| BOHLER | Traction Bow | 44 | KIRMISSION | Periosteal Raspatory | 28 |
| BRUNS | Bandage Scissors | 20 | KLEINERT-KUTZ | Bone Cutting Forceps | 35 |
| BRUNS | Bone Curettes | 55 | KLEINERT-KUTZ | Bone Rongeur | 63,64 |
| BRUNS (VOLKMANN) | Bone Curettes | 56,58 | KOCHER | Hemostatic Forceps | 11 |
| CHARRIERE | Amputation Saw | 44 | KONRICH | Sterilizing Dressing Drums | 17 |
| CHEATLE | Sterilizing Forceps | 17 | LAMBOTTE | Bone Holding Forceps | 41,42 |
| CHERON | Dressing Forceps | 8 | LAMBOTTE | Chisels | 52 |
| CLEVELAND | Bone Cutting Forceps | 34 | LAMBOTTE | Raspatories | 29 |
| COBB | Elevators | 29 | LANE | Bone Holding Forceps | 41 |
| COBB | Gouges | 51 | LANGE-HOHMANN | Bone Levers | 32 |
| COLLIN | Mallet | 23 | LANGENBECK | Amputation Saw | 44 |
| COTTLE | Mallet | 24 | LANGENBECK | Bone Holding Forceps | 39 |
| COTTLE-KAZANJIAN | Bone Cutting Forceps | 34 | LANGENBECK | Elevators & Raspatories | 29,30 |
| CRILE-WOOD | Needle Holder | 13 | LANGENBECK | Raspatories | 29 |
| CRILE-WOOD | Needle Holder, TC | 13 | LANGENBECK | Retractors | 15 |
| CUSHING | Perforator | 68 | LEKSELL | Bone Rongeur | 66 |
| DAHMEN | Chisel | 53 | LEKSELL-STILLE | Bone Rongeur | 66 |
| DINGMAN | Bone Holding Forceps | 38 | LEMPERT | Bone Rongeur | 65 |
| DOYEN | Mallets | 24 | LEMPERT | Periosteal Elevators | 27 |
| DOYEN | Raspatories | 30 | LEWIN | Bone Holding Forceps | 39 |
| ECHLIN | Bone Rongeur | 66 | LEXER | Chisels & Gouges | 51,53,54 |
| ENGEL | Plaster of Paris Saw | 21 | LISTER | Bandage Scissors | 20 |
| ESMARCH | Bandage Scissors | 20 | LISTER | Bandage Scissors, TC | 20 |
| ESMARCH | Plaster of Paris Knives | 21 | LISTON | Bone Cutting Forceps | 34,35 |
| FARABEUF | Bone Holding Forceps | 41 | LISTON-KEY | Bone Cutting Forceps | 36 |
| FARABEUF | Raspatories | 28 | LISTON-MINI | Bone Cutting Forceps | 35 |
| FARABEUF | Retractor | 15 | LISTON-STILLE | Bone Cutting Forceps | 35 |
| FARABEUF-BABY | Retractor | 15 | LITTAUER-LISTON | Bone Cutting Forceps | 34 |
| FARABEUF-LAMBOTTE | Bone Holding Forceps | 41 | LOUTE | Wire Twister | 45 |
| FERGUSSON | Bone Holding Forceps | 39 | LOWMAN | Bone Holding Clamps | 37 |
| FOERSTER | Sponge Holding Forceps | 8 | LUCAE | Mallets | 23 |
| FREER | Elevators | 29 | LUCAS | Chisels & Osteotomes | 50 |
| FRIEDMAN | Bone Rongeur | 60 | LUER | Bone Rongeur | 62,63 |
| FRYKHOLM | Bone Rongeur | 67 | MARQUARDT | Bone Rongeur | 65 |
| GEMINI | Dissecting & Ligature Forceps | 12 | MARTIN | Bone Holding Forceps | 39 |
| GERSTER-LOWMANN | Bone Holding Forceps | 37 | MARTINI | Bone Curettes | 58 |
| GERZOG | Mallet | 22 | MATHIEU | Needle Holder, TC | 14 |
| GIGLI | Wire Saws & Handle | 44 | MATHIEU-KOCHER | Needle Holder, TC | 14 |
| HAJEK | Mallet | 23 | MAYFIELD | Bone Rongeur | 65 |
| HALLE | Bone Curettes | 57 | MAYO | Operating & Dissecting Scissors | 3 |
| HALSTEAD-ADSON | Hemostatic Forceps | 11 | MAYO | Operating & Dissecting Scissors, TC | 4 |

INDEX

| | | | | | |
|---------------------|-------------------------------------|----------|----------------|---------------------------------|-------|
| MAYO | Safety Pin | 17 | STILLE | Bone Rongeurs | 66 |
| MAYO-HARRINGTON | Operating & Dissecting Scissors | 3 | STILLE | Chisels & Gouges | 48,49 |
| MAYO-HARRINGTON | Operating & Dissecting Scissors, TC | 4 | STILLE | Plaster Shears | 21 |
| MAYO-HEGAR | Needle Holders | 13 | STILLE-LEKSELL | Bone Rongeurs | 65 |
| MAYO-HEGAR | Needle Holders, TC | 13 | STILLE-LUER | Bone Rongeurs | 66,67 |
| MAYO-STILLE | Operating & Dissecting Scissors | 3 | STILLE-RUSKIN | Bone Rongeurs | 66 |
| MAYO-STILLE | Operating & Dissecting Scissors, TC | 4 | TAYLOR | Bone Levers | 32 |
| MCDONALD | Dissector | 26 | THIESS | Mallet | 23 |
| MCINDOE | Bone Cutting Forceps | 35 | TRAUTMANN | Chisels & Gouges | 48 |
| MEAD | Bone Rongeur | 60,61 | ULRICH | Bone Holding Forceps | 40 |
| MEAD | Mallets | 22 | UNIVERSAL | Bandage & Wire Cutting Scissors | 20 |
| METZENBAUM | Dissecting Scissors, TC | 5 | UNIVERSAL | Bone Rongeur | 60 |
| METZENBAUM (LAHEY) | Dissecting Scissors, TC | 5 | UNIVERSAL | Wire Cutter | 46 |
| MILLER | Bone Rasps | 25 | UNIVERSAL | Wire Cutter, TC | 46 |
| MINI-FRIEDMAN | Bone Rongeur | 60 | VAN BUREN | Bone Holding Forceps | 37 |
| MINI-HOHMANN | Bone Levers | 31 | VERBRUGGE | Bone Holding Forceps | 42 |
| MINI-LAMBOTTE | Chisels | 48 | VOLKMANN | Bone Curettes | 57,59 |
| MINI-LEXER | Chisels & Gouges | 54 | VOLKMANN | Retractors | 15 |
| MIXTER | Dissecting & Ligature Forceps | 12 | WALTON | Finger Ring Cutter | 68 |
| MIXTER-BABY | Dissecting & Ligature Forceps | 12 | WEITLANER | Retractors | 16 |
| MOD. USA | Plaster Cast Breaker | 21 | WIGMORE | Plaster of Paris Saw | 21 |
| MOLT | Periosteal Elevators | 26 | WILLIGER | Bone Curettes | 58 |
| MOYNIHAN | Hemostatic Forceps | 11 | WILLIGER | Elevators | 26 |
| NELSON (METZENBAUM) | Dissecting Scissors, TC | 5 | WILLIGER | Mallets | 24 |
| OLIVECRONA | Bone Rongeur | 61 | WILLIGER | Raspatories | 26 |
| OMBERDANNE | Mallet | 24 | WOLFF | Plaster Cast Breaker | 21 |
| PARTSCH | Chisels & Gouges | 48 | YANKAUER | Suction Tubes | 2 |
| PARTSCH | Mallet | 23 | ZAUFAL-JANSEN | Bone Rongeur | 64 |
| PEAN | Hemostatic Forceps | 11 | | | |
| POOLE | Suction Tubes | 2 | | | |
| POTTS-SMITH | Dissecting Forceps, TC | 7 | | | |
| PUTTI | Bone Files | 25 | | | |
| RADOLF | Nail Pulling Forceps | 68 | | | |
| RANKIN-CRILE | Hemostatic Forceps | 8 | | | |
| RANKIN-KELLY | Hemostatic Forceps | 8 | | | |
| REINER | Plaster of Paris Knife | 21 | | | |
| ROCHESTER-OSCHNER | Hemostatic Forceps | 10 | | | |
| ROCHESTER-PEAN | Hemostatic Forceps | 9 | | | |
| RUSKIN | Bone Rongeur | 63,64,67 | | | |
| RUSKIN-LISTON | Bone Cutting Forceps | 36 | | | |
| RUSKIN-MINI | Bone Rongeur | 64 | | | |
| RUSKIN-ROWLAND | Bone Cutting Forceps | 36 | | | |
| RYDER (FRENCH EYE) | Needle Holders, TC | 14 | | | |
| SATTERLEE | Amputation Saw | 44 | | | |
| SCHEDE | Bone Curettes | 57 | | | |
| SCHELL | Bone Rongeur | 61 | | | |
| SCHIMMELBUSCH | Sterilizing Dressing Drums | 17 | | | |
| SEDILLOT | Raspatories | 27 | | | |
| SEMB | Bone Cutting Forceps | 36 | | | |
| SEMB | Bone Holding Forceps | 39 | | | |
| SEMB | Bone Rongeur | 67 | | | |
| SEMB | Raspatories | 28 | | | |
| SENN-MUELLER | Retractors | 15 | | | |
| SEUTIN | Bandage Scissors | 20 | | | |
| SMILLIE | Knee Retractors | 33 | | | |
| SMILLIE | Meniscotomes | 54 | | | |
| SMITH-PETERSON | Bone Rongeurs | 63 | | | |
| SMITH-PETERSON | Chisels & Gouges | 52 | | | |
| SPRATT | Bone Curettes | 56 | | | |
| STELLBRINK | Bone Rongeurs | 63 | | | |