

CH 05

Root Elevators
Wurzelheber
Elevadores para raíces
Élévateurs à racines
Leve per radici





Choice of Handles for Root Elevators.

If you wish to order a different type (A, B, C, D, E, F and G) of handle for a particular product, please mention **that** type with the code number of that product.

Example : 05-0701E

If you wish to order a particular type (A, B, C, D, E, F and G) of handle with all instruments, please mention **that** type in your purchase order.

Example : Please use handle C for all Scalers.



A B



C D E F G

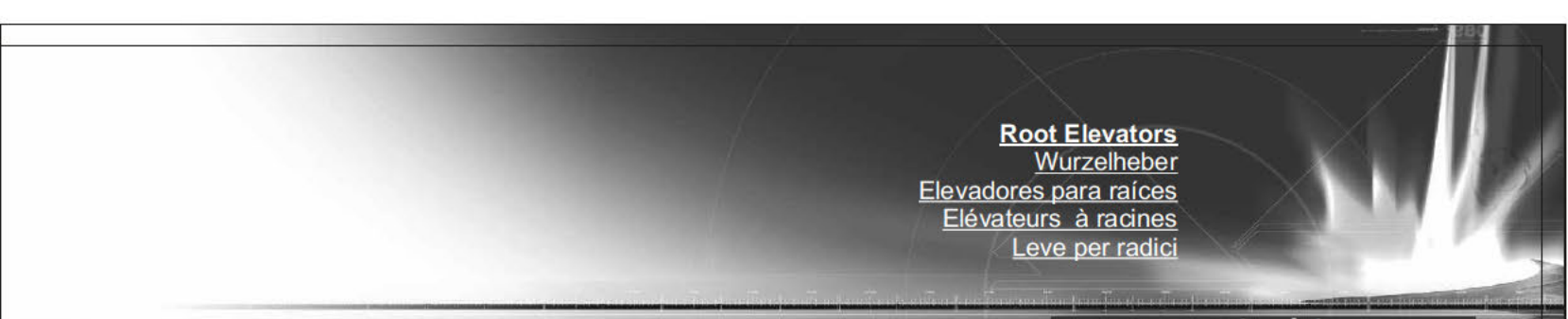

Root Elevators
 Wurzelheber
 Elevadores para raíces
 Elévateurs à racines
 Leve per radici

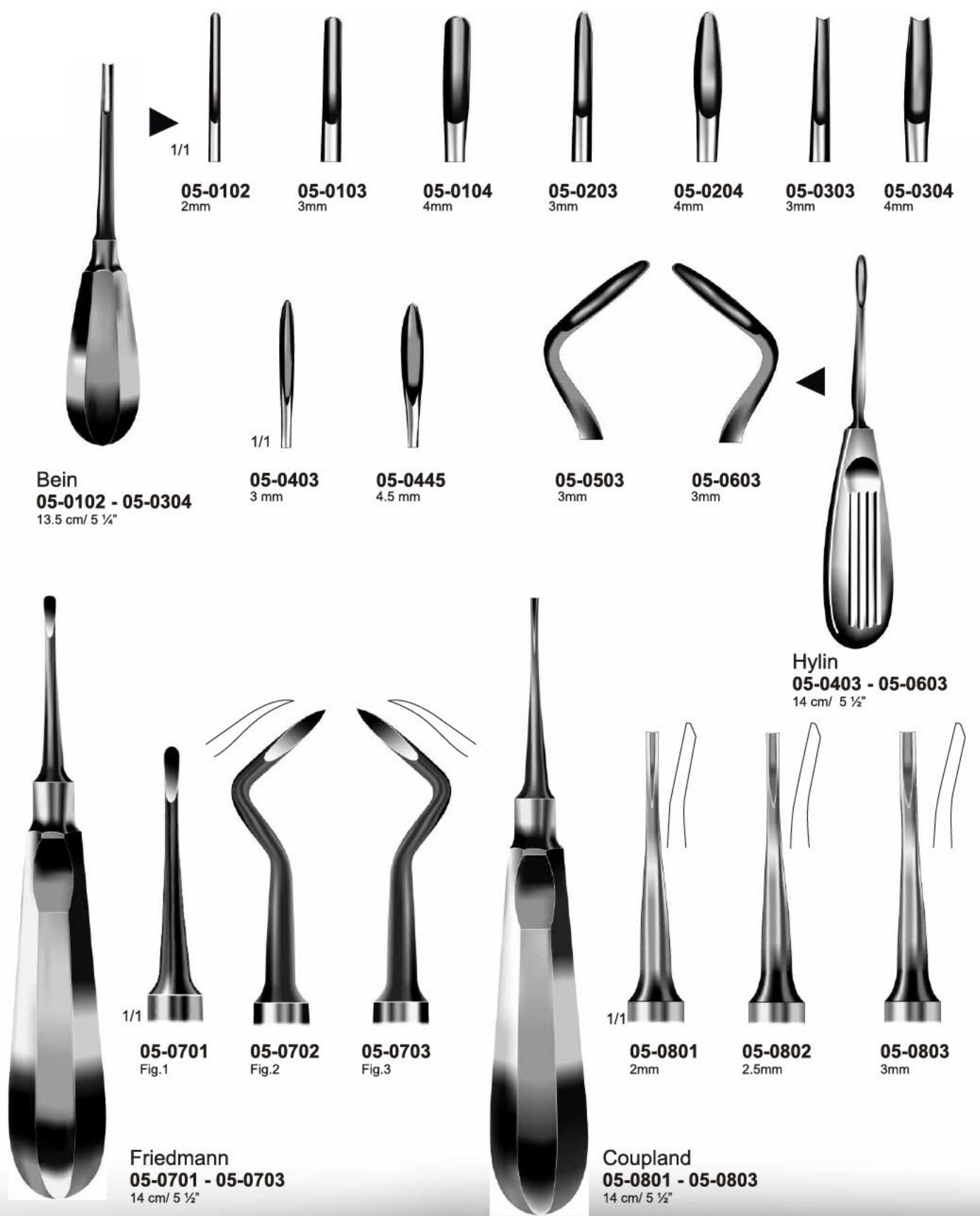

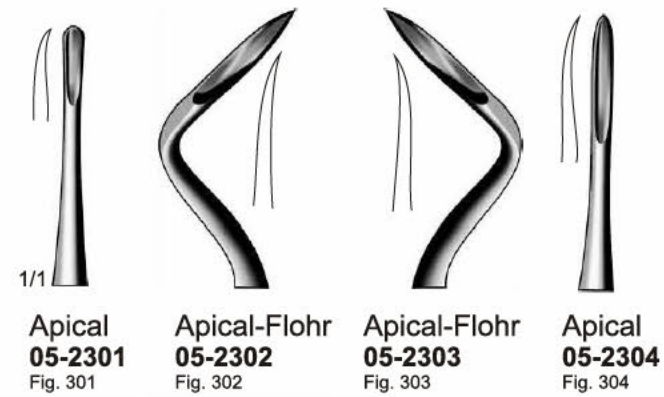
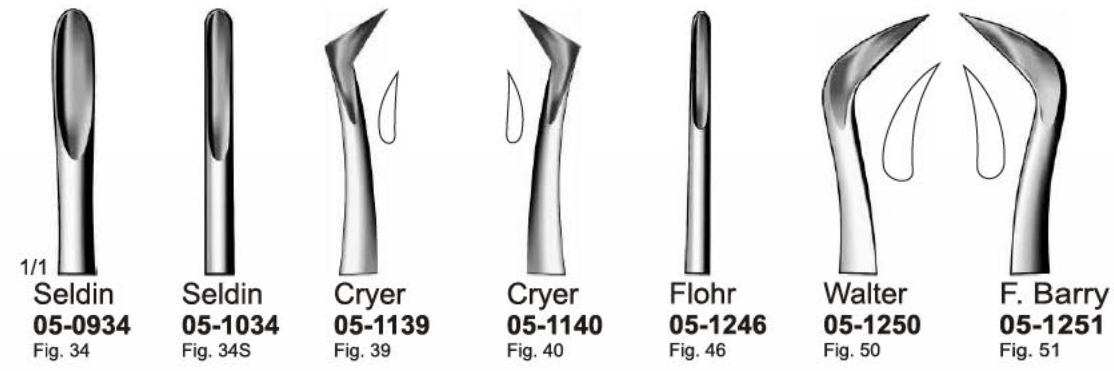

05-0934 - 05-2304
 13.5 cm/ 5 1/2"

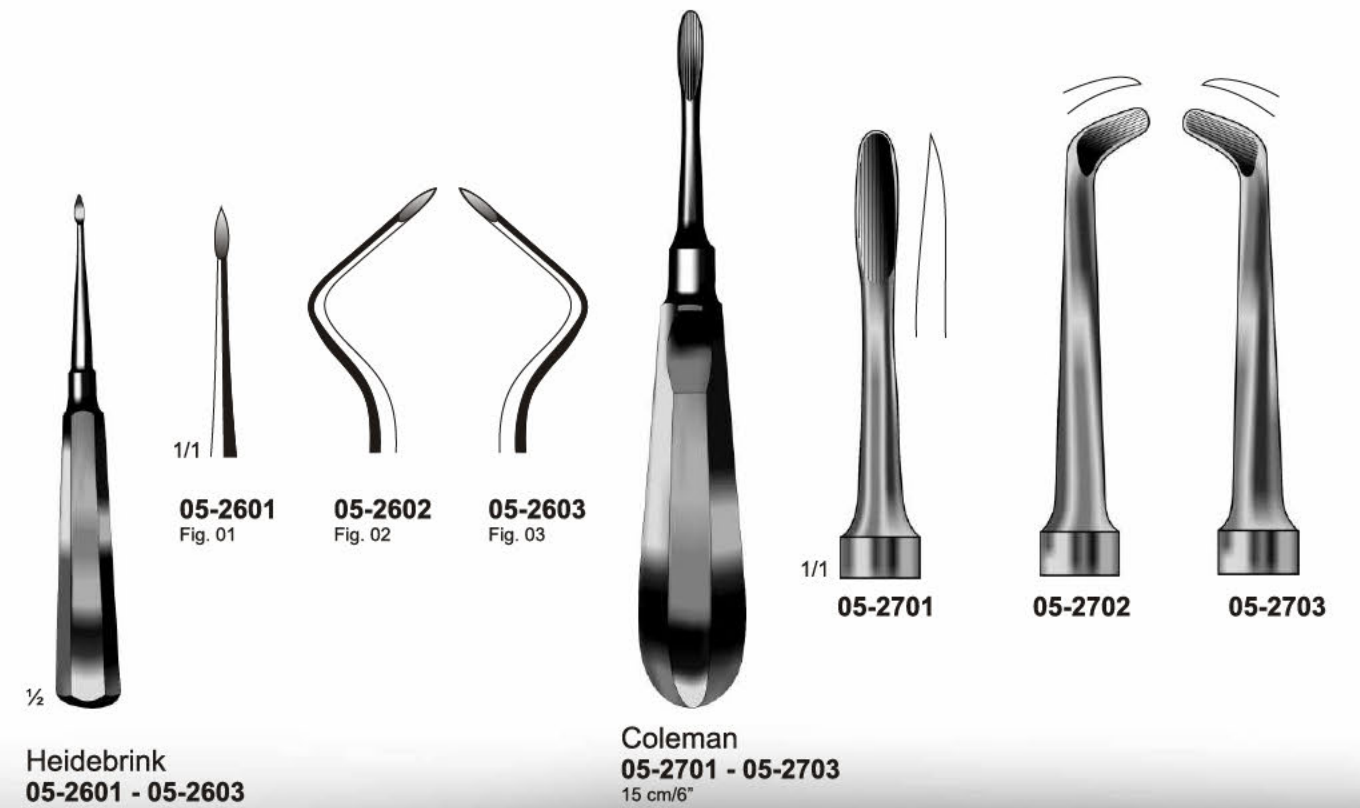
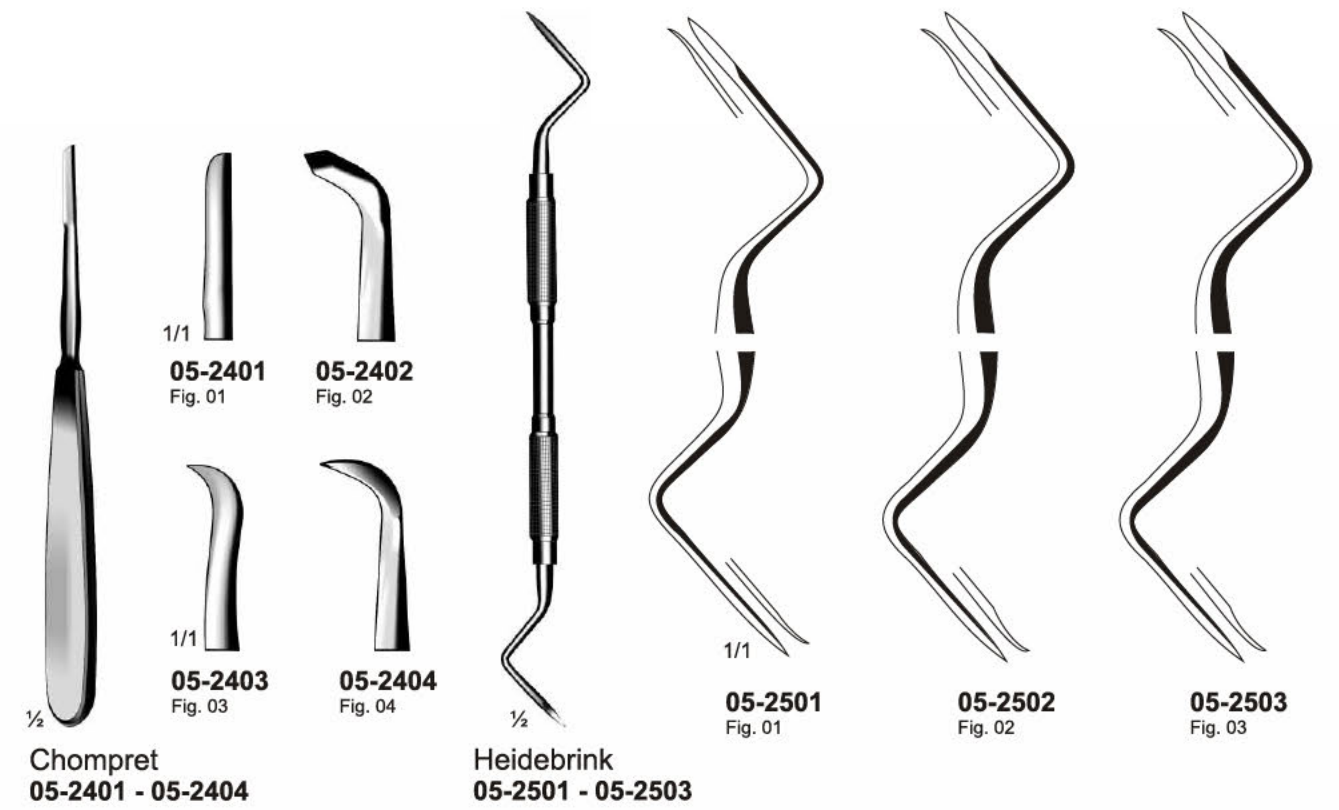

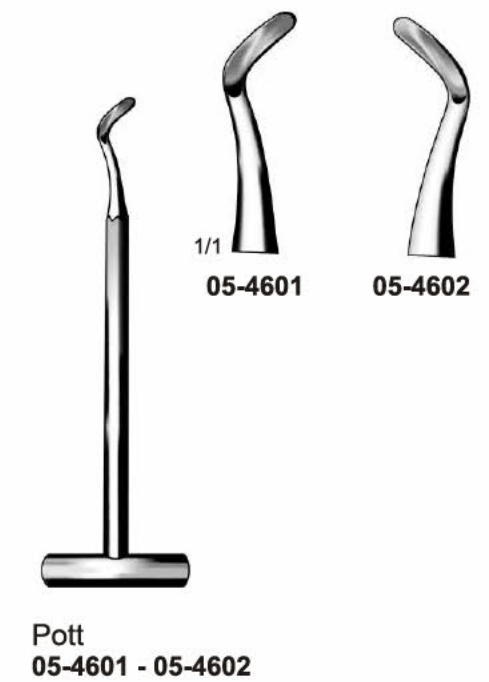
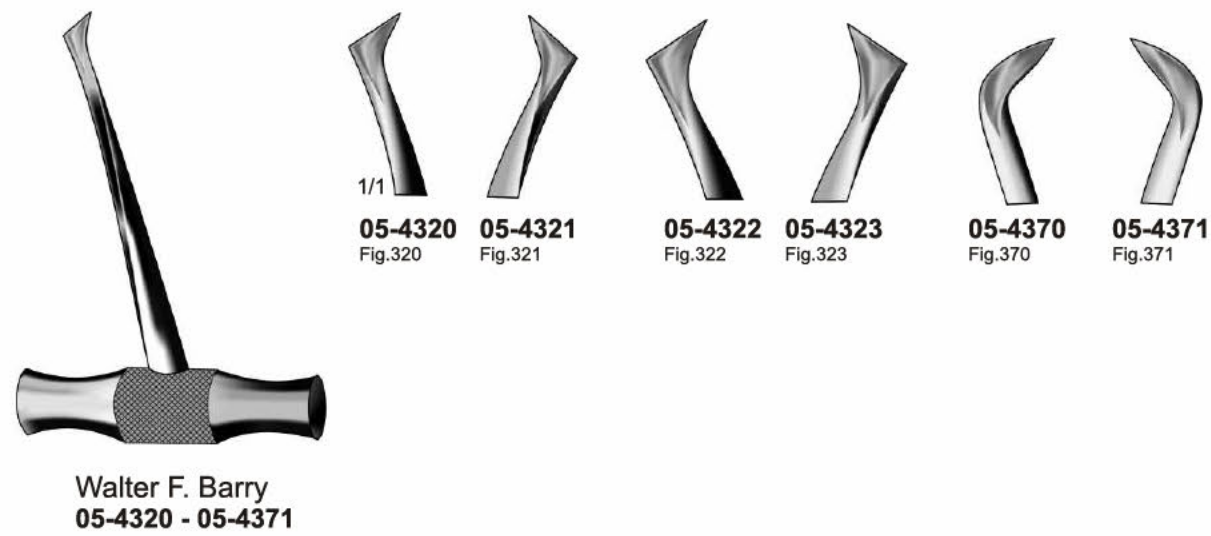
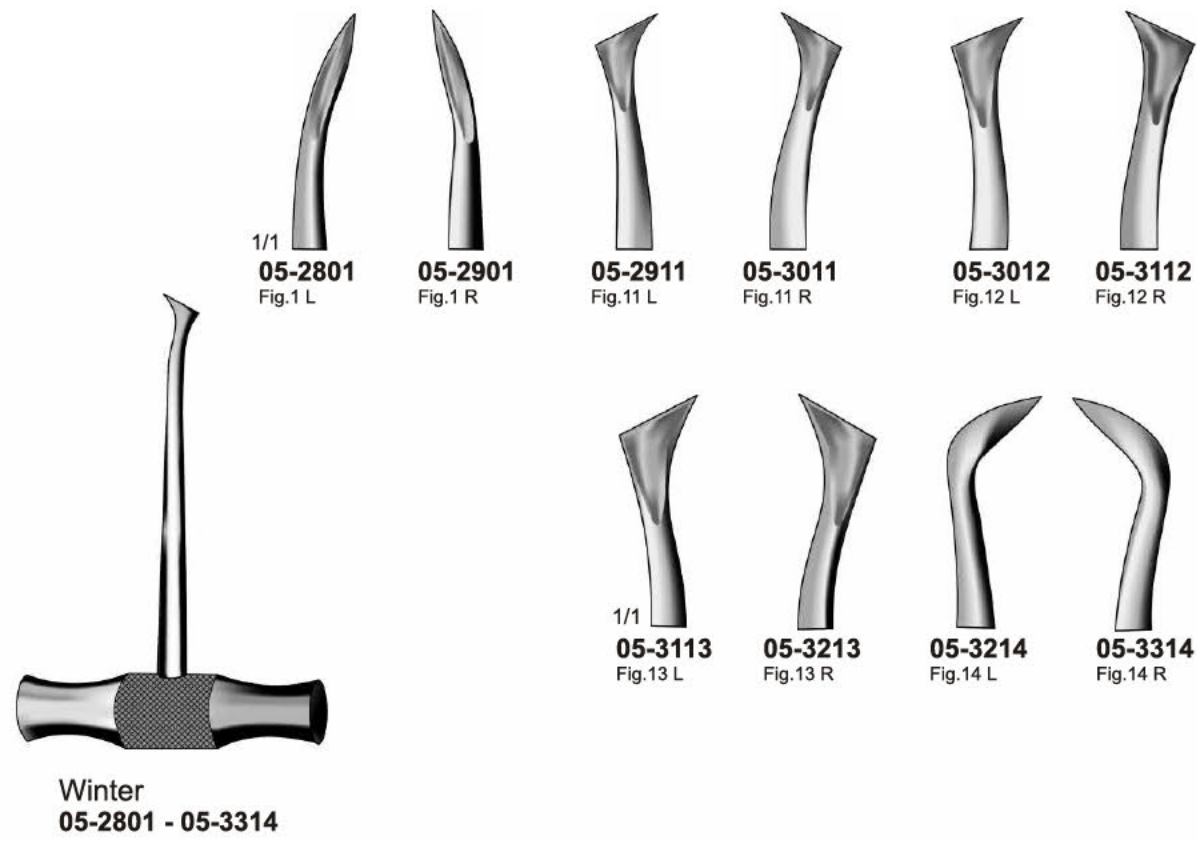

Root Elevators
 Wurzelheber
 Elevadores para raíces
 Élévateurs à racines
 Leve per radici

CH 05

www.surgical-i.com



West
05-4723
 Fig. 2/3

West
05-4756
 Fig. 5/6

Warwick-James
05-4801
 16 cm/ 6 1/4"

Warwick-James
05-4802
 16 cm/ 6 1/4"

Warwick-James
05-4803
 16 cm/ 6 1/4"

Walter F. Barry
05-4904 - 05-4906