



Professional solutions for dental surgeons

[www.surgical-i.com](http://www.surgical-i.com)

**Surgical-i**

Precision | Performance | Innovation

Dental Instruments  
Dental-Instrumente  
Instrumentos Odontológicos  
Instruments Dentaire  
Strumentali Dentali

**4th Edition**



## Professional solutions for dental surgeons

A craftsman is known by his tools. Today's dental surgeons are master craftsmen in their field and require precision instruments of the highest quality to perform the delicate procedures that bring **smiles** to thousands of faces around the world.



Our Dental Instruments are developed to unique specifications with added features that are matched to the needs of market sectors in over 52 countries. Over 12,000 instruments, each of the finest quality, cover the entire range of general and specialized dental surgery.

With the knowledge born of 32 years of experience in the field, we are in a position to provide customized solutions, offer advice and guide you in instrument planning. We are happy to answer any query and as an innovative and reliable partner, help you solve any individual problem.

This 'Product Catalogue' provides you with technical data and information on how to order from our wide range of instruments that include Extracting Forceps, Root Elevators, Scalars, Curettes, Explorers, Excavators, Pliers, Tweezers, Impression Trays, Plastic Filling instruments and other general surgery instruments.

Please feel free to ask for any other information, other product catalogues, or any dental product not featured in this catalogue. Product information updates are available on our website [www.surgical-i.com](http://www.surgical-i.com)

# Care for Dental Instruments

*"The cost of maintenance is lesser than the cost of new instruments."*

## **The Quality, To Begin With**

Every Surgical-i instrument passes through a system of strict quality control after each manufacturing step, guaranteeing the highest quality only. The quality control is both the inherent one and the one complying with international standards.

## **The Steel, To Be Sure**

We procure our own special steel with a higher percentage of carbon and chromium. Instruments fabricated out of this steel guarantee a longer life and durable functionality, ensuring satisfaction to users.

## **Experienced Craftsmen, To Create Master Pieces**

All instruments are crafted by hand. Be it forging, machining, grinding and sharpening, all these processes are performed by our trained and experienced craftsmen. During manufacturing, every single instrument passes through numerous steps and every step is followed by an inspection process. We do understand what depends on the high quality of our instruments and to this end we allocate our best resources.

## **Intended And Specified Use, The Long Life**

Always use the instrument for the function it has been designed for. Dental instruments are ultra fine precision instruments. A misuse can result in severe damage to the working points. Increase the life of instrument by its proper and correct use only. A pair of scissors is meant for cutting soft tissues only. It should not be used to lift bones or for exploring and scrapping purpose.

## **Disinfection, Cleaning And Sterilization**

Always clean the instruments before sterilization. If the instruments are sterilized without cleaning, the stains on them can be burnt into the instruments leaving permanent marks. This is because of very high temperature during sterilization.

Before cleaning, instruments should be disinfected using a suitable disinfectant preferably the one not containing Phenol.

Manual cleaning should begin soon after the surgeries are over. Do not delay cleaning. Use a soft brush and not a steel wool or drill brush to clean the instruments to remove stubborn impurities. Instruments should always be cleaned in a non-corrosive, natural cleaning agent with little foaming. The instruments should then be rinsed in distilled water.

The use of ultrasonic cleaners and thermo-disinfectant is also becoming common. Here again, care must be taken in the selection of cleaning agents, detergents and disinfectants. Please ensure that they do not damage the metal. Always remember these methods can clean but do not sterilize!

## Some Important Care Tips:

- Before sterilization, always inspect your equipment for any dirt remains or any organic or mineral deposits. The extreme heat can cause these deposits to be permanently burnt into the instrument, increasing chances of corrosion.
- Never mix stainless steel with other metals like aluminum, brass or copper. This can cause electrochemical changes and also produce etching or staining.
- Use distilled or demineralized water only.
- Always follow the manufacturer's instructions precisely when it comes to the temperatures and times involved for autoclaving, dry heating or germicidal solvents.
- Dry each instrument separately and completely. In case of remaining moisture, dry using a sterile cloth.
- Always use physiological oil and other suitable lubricants to keep instruments well oiled. This is especially required for instruments comprising many parts like scissors, pliers and gouges. A regular use of oil prevents stiffness and corrosion and results in smooth functioning.
- Hinged instruments like forceps and needle holders should always be opened for cleaning and sterilization.
- Etching or engraving instruments for personal identification can damage the instrument itself and cause damage to other instruments as well. Damage to the polished surface can always lead to corrosion.
- Although stainless steel has outstanding corrosion resistant properties, contact with certain chemicals must be avoided.

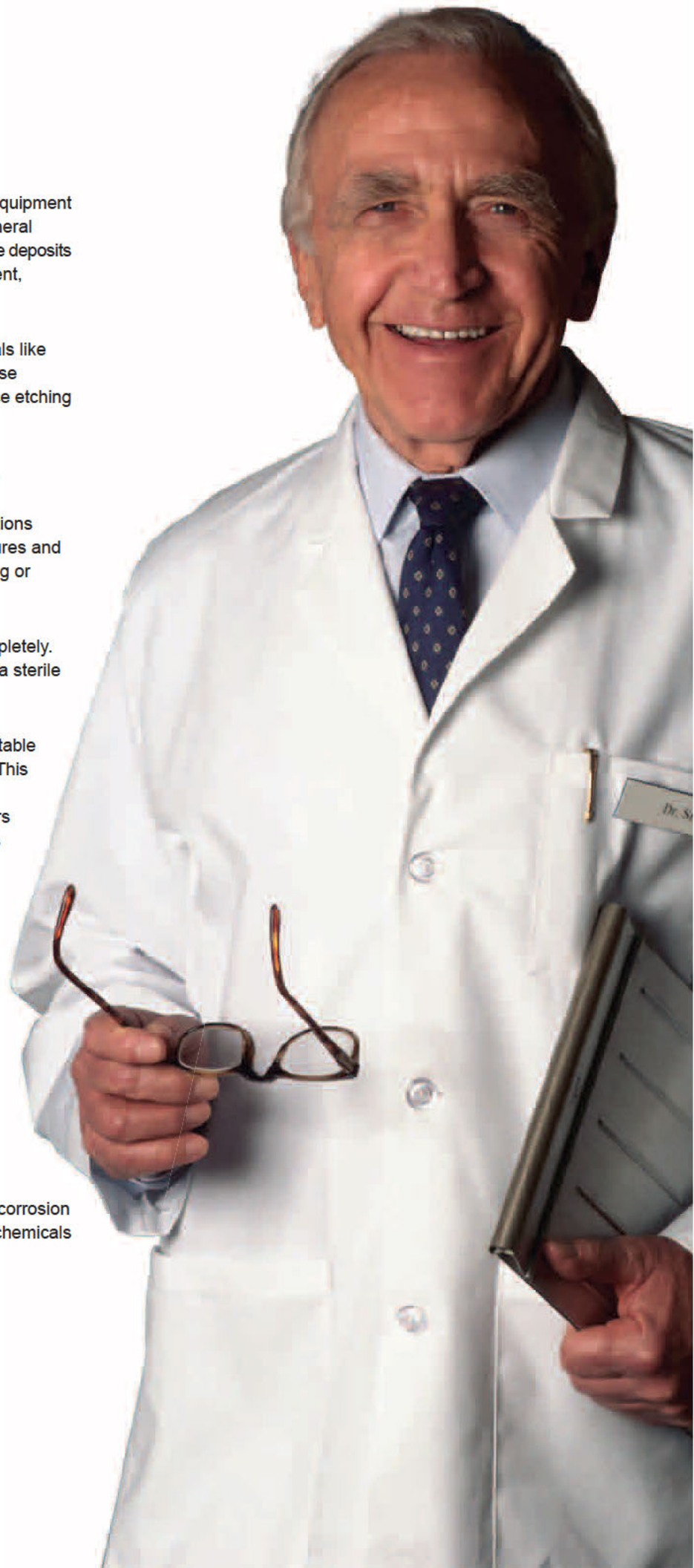

# Table of Contents

<b>Chapter 1</b>	<b>01</b>	<b>Chapter 5</b>	<b>25</b>
<b>Dental Extraction Forceps</b> Zahnzangen Forceps de extracción Daviers Pinze per estrazioni		<b>Root Elevators</b> Wurzelheber Elevadores para raíces Elévateurs à racines Leve per radici	
<b>English Pattern</b> Englische Form Forma inglesa Forme anglaise Forma inglese		<b>Chapter 6</b>	<b>33</b>
<b>Chapter 2</b>	<b>11</b>	<b>Amalgam Instruments</b> Amalgaminstrumente Instrumentos para amalgama Instruments à amalgame Strumenti per amalgma	
<b>Dental Extraction Forceps</b> Zahnzangen Forceps de extracción Daviers Pinze per estrazioni		<b>Chapter 7</b>	<b>45</b>
<b>With Alpha Handle</b> Mit Alfa-Griff Con mango Alfa Manche Alfa		<b>Scalers, Curettes</b> Zahnreiniger, Küretten Limpiadores de sarro, Curetas Instruments à détartrer, Curettes Scaler, Curette	
<b>Chapter 3</b>	<b>12</b>	<b>Chapter 8</b>	<b>49</b>
<b>Dental Extraction Forceps</b> Zahnzangen Forceps de extracción Daviers Pinze per estrazioni		<b>Periodontia Instruments</b> Instrumente Zur paradontologie Instrumentos para periodoncia Instruments pour la parodontologie Strumenti per parodontologia	
<b>For children</b> Kinderzahnzangen Para niños Pour enfants Per bambini		<b>Chapter 9</b>	<b>57</b>
<b>Chapter 4</b>	<b>16</b>	<b>Excavators, Probes &amp; Explorers, Nerve instruments</b> Exkavatoren, Zahnsonden, Nervinstrumente Excavadores, sondas y exploradores Instrumentos para nervios Excavateurs, Sondes, et explorateurs Escavatori, Sonde, Strumenti per nervi	
<b>Dental Extraction Forceps</b> Zahnzangen Forceps de extracción Daviers Pinze per estrazioni		<b>Chapter 10</b>	<b>67</b>
<b>American Pattern</b> Amerikanische form Forma americana Forme américaine Forma americana		<b>Wax and Crown Instruments, Matrix Instruments</b> Wachs-kroneninstrumente, Matrizen-instrumente Instrumentos para cera, coronas, instrumentos para matrices Instruments pour couronnes et matrices Strumenti per cera e per corone	

**Chapter 11** 75**Impression Trays**

Abdrucklöffler  
Portamoldes  
Porte-empreintes  
Porta-impronte

**Chapter 12** 87**Pliers For Orthodontics**

Zangen für Kieferorthopädie  
Pinzas para orthodoncia  
Pinces pour orthodontie  
Pinze per Ortodonzia

**Chapter 13** 97**Knives, Scalpels**

Messer, Skalpelle  
Bisturies  
Bistouris  
Bisturi

**Chapter 14** 99**Scissors**

Scheren  
Tijeras  
Ciseaux  
Forbici

**Chapter 15** 102**Forceps**

Pinzetten  
Pinzas  
Pinces  
Pinzette

**Hemostatic Forceps**

Arterienklemmen  
Pinzas hemostaticas  
Pinces hémostatiques  
Pinze emostatiche

**Chapter 16** 107**Needle holders**

Nadel halter  
Portaagujas  
Porte-aiguilles  
Porta aghi

**Chapter 17** 109**Retractor**

Wundhaken  
Separadores  
Ecarteurs  
Retrattori

**Chapter 18** 112**Bone Cutting Forceps,****Bone Rongeurs**

Hohlemeißelzangen,  
Knochen Splitterzangen  
Pinzas Cortentes para huesos  
Pinces à os coupantes,  
Pinces-gouges  
Scalpellini e pinze alveolotome

**Tongue Depressors, Mouth Gags**

Zungenspatel, Mundsperrer  
Bajalenguas, Abrebocas  
Abaisse-langues, Ouvre-bouches  
Spatola per lingu, a Abribocca

**Bone Chisels, Curettes**

Flachmeißel, Scharfe Löffel  
Cinceles, Cucharillas Cortantes  
Ciseaux-burins, Curettes tranchantes  
Scalpelli, Cucchiaini per osso

**Chapter 19** 119**Sterilization, Asepsis**

Sterilisation, Asepsis  
Esterilización, Asepsia  
Stérilisation, Asepsis  
Sterilizzazione, Asepsi

**Chapter 20** 125**Surgery**

Chirurgia  
Chirguia  
Chirurgie  
Chirurgia

**Chapter 21** 131**Dental instruments sets**

Satz Instrumente  
Sistema de instrumentos  
Ensemble d' instruments  
Insieme degli strumenti





## Professional Innovations

Dental hand instruments are now available in coloured handles and detachable/replaceable tips.

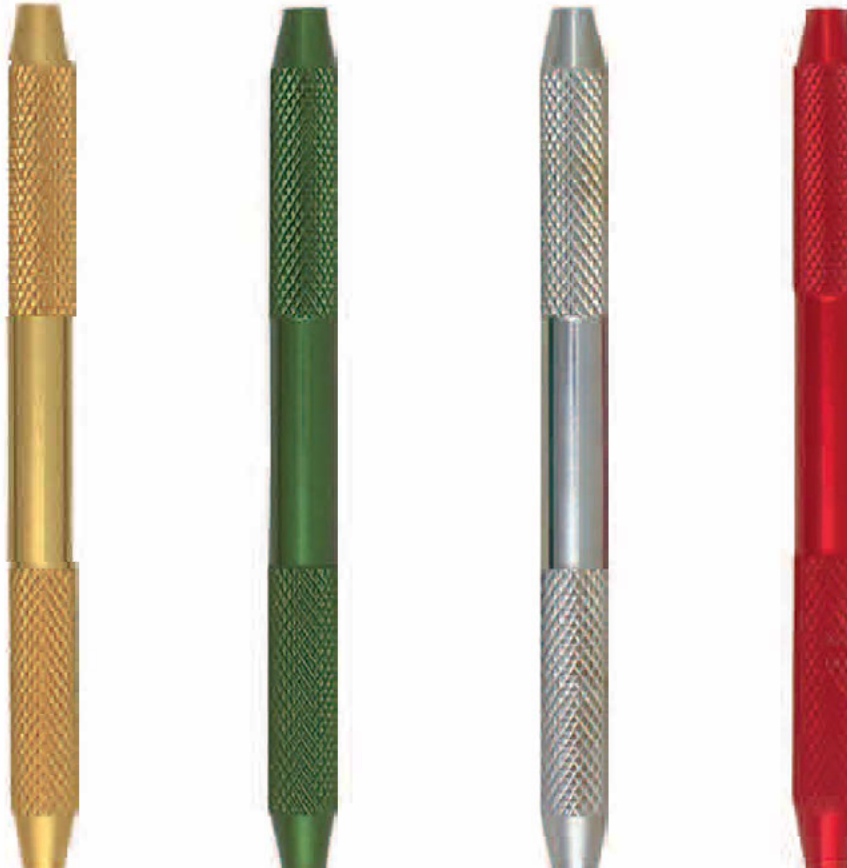

To order any instrument in color handle with detachable tip, please use following colours codes.

X S = Silver  
X R = Red  
X G = Green  
X B = Blue  
X Y = Yellow

*Example*

**06-1006** Hollenback Amalgam instrument in normal stainless steel handle.

**06-1006-XB** same but with detachable tips and blue handle.

*Tips only for all models featured in this catalogue can also be ordered separately.  
Please use the **suffix-TP** with any code number to order tips only.*

*Example*

**06-1006-TP** to order tips only for Hollenback Amalgam instruments.



# Standards & Regulations for Dental Instruments

The quality management system at Surgical-i conforms to International Standard ISO 9001: 2000 and also to other applicable specific standards for medical devices.

The EC Medical Device Directive # 93/42/EEC regulates and harmonizes the conditions for marketing and use of medical products. This directive sets the rules for classification of all medical products according to their risks category. (Annex IX).

All dental surgery instruments are assigned to Low Risk class I category, for which the directive imposes the following obligations for manufacturers.

- The products must comply with essential requirements applicable for their intended application.
- Implementation of conformity assessment and attachment of CE mark.
- Management of the technical documentation (for perusal by the national and international authorities).

Having met all these requirements, all professional instruments bear CE mark.

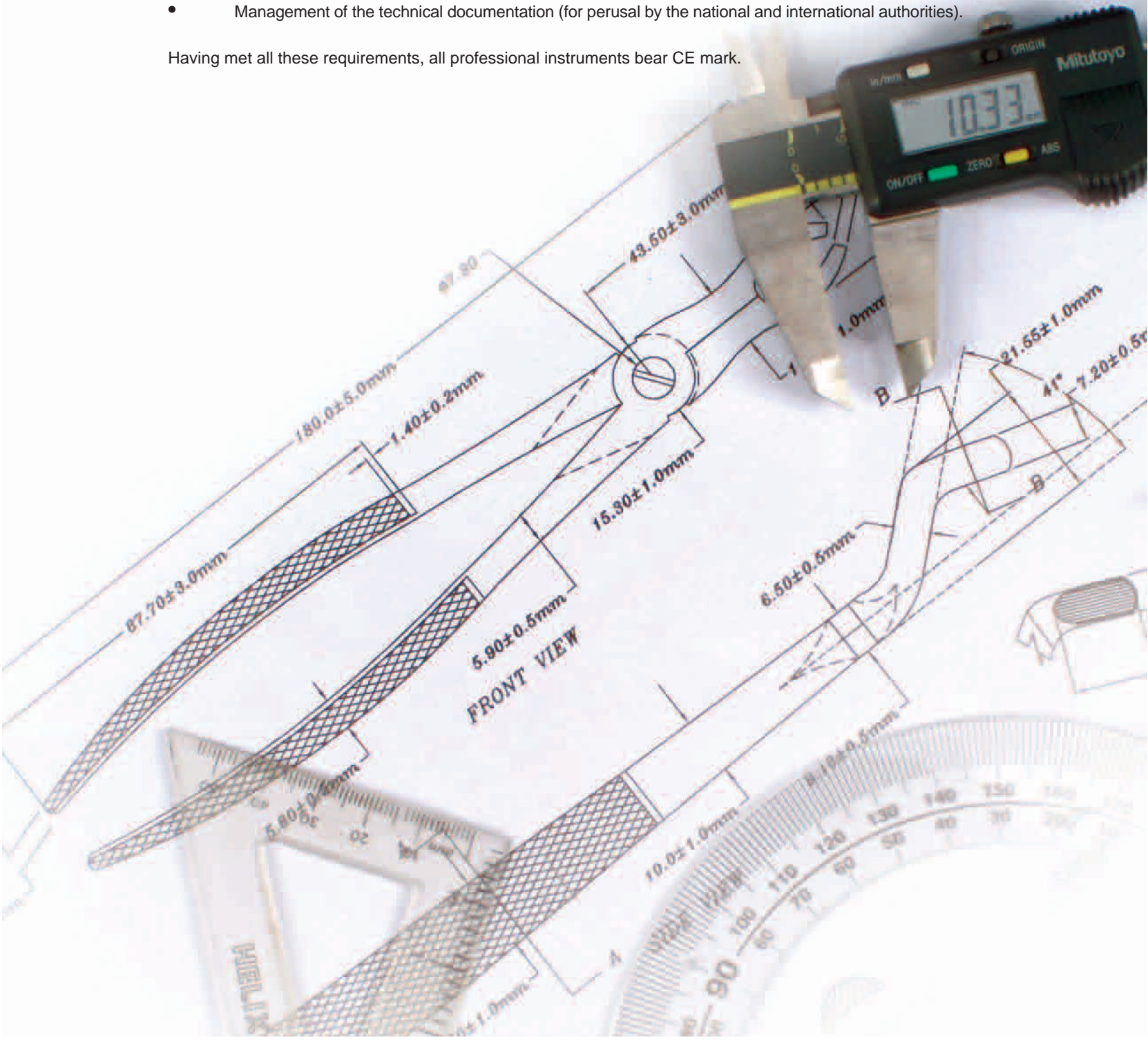

# CH 01-04

**CH 01** English Pattern  
Englische Form  
Forma inglesa  
Forma anglaise  
Forma inglese

**CH 02** With Alpha Handle  
Mit Alfa-Griff  
Con mango Alfa  
Manche Alfa  
Maniglia dell'alfa

**CH 03** For children  
Kinderzahnzangen  
Para niños  
Pour enfants  
Per bambini

**CH 04** American Pattern  
Amerikanische form  
Forma americana  
Forme américaine  
Forma americana

## Dental Extraction Forceps

Forceps de extracción

Zahnzangen

Daviers

Pinze per estrazioni



**Extracting Forceps, English Pattern**  
 Zahnzangen, englische form  
 Forceps de extracción, forma inglesa  
 Daviers, forma anglaise  
 Pinze per estrazioni, forma inglese

www.surgical-i.com

All Extracting Forceps are also available in Non-Slip Grip Jaws. Please see page 11 for ordering details.



- 01 0101 For Upper Centrals And Canines
- 01 0102 For Upper Laterals And Bicusprds
- 01 0103 For Upper Incisors And Canines  
Crowded Internally Or Externally
- 01 0104 For Lower Incisors And Canines
- 01 0107 For Upper Bicuspsids Either Side
- 01 0108 For Lower Bicuspsids Either Side
- 01 0113 For Lower Bicuspsids Either Side

**Extracting Forceps, English Pattern**  
 Zahnzangen, englische form  
 Forceps de extracción, forma inglesa  
 Daviers, forma anglaise  
 Pinze per estrazioni, forma inglese

www.surgical-i.com



- 01-0117 For Right Upper Molars
- 01-0118 For Left Upper Molars
- 01-0218 For Upper Molars, Either Side
- 01-0219 For Upper Wisdoms, Either Side
- 01-0220 For Lower Wisdoms, Either Side
- 01-0221 For Lower Molars, Either Side
- 01-0222 For Lower Molars, Either Side (Hawk's Bill)

**Extracting Forceps, English Pattern**  
 Zahnzangen, englische form  
 Forceps de extracción, forma inglesa  
 Daviers, forma anglaise  
 Pinze per estrazioni, forma inglese

**Extracting Forceps, English Pattern**  
 Zahnzangen, englische form  
 Forceps de extracción, forma inglesa  
 Daviers, forma anglaise  
 Pinze per estrazioni, forma inglese

All Extracting Dental Forceps are also available in Non-Slip Grip Jaws.  
 Please see page 11 for ordering details.



**01-0223**  
Fig. 23



**01-0224**  
Fig. 24



**01-0229**  
Fig. 29

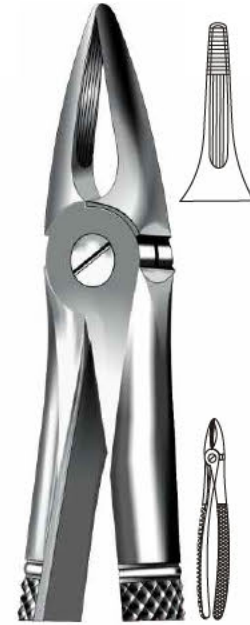

**01-0329**  
Fig. 29 N



**01-0330**  
Fig. 30



**01-0331**  
Fig. 31



**01-0333**  
Fig. 33



**01-0433**  
Fig. 33 A



**01-0533**  
Fig. 33 C



**01-0633**  
Fig. 33 M

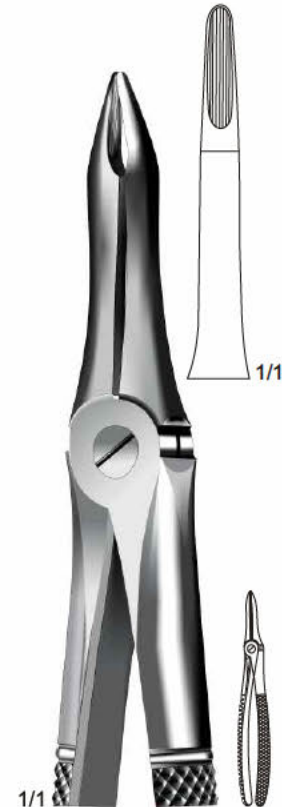

**01-0641**  
Fig. 41



**01-0644**  
Fig. 44



**01-0645**  
Fig. 45

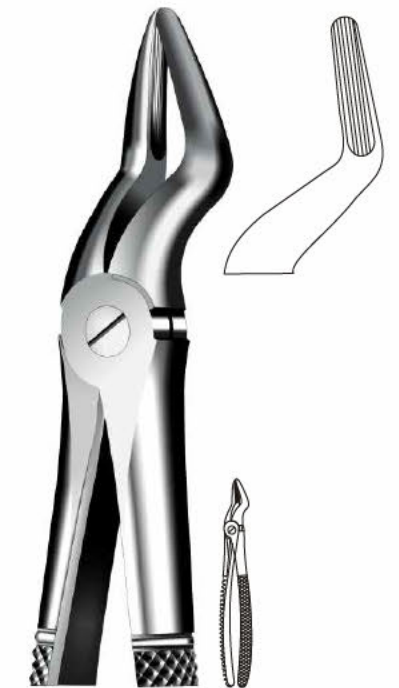

**01-0651**  
Fig. 51

- 01-0233 For Right Lower Molars
- 01-0224 For Left Lower Molars
- 01-0229 For Upper Roots And Incisors, Either Side
- 01-0329 For Roots Of Upper Incisors
- 01-0330 For Lower Roots And Incisors
- 01-0331 For Lower Roots, Either Side
- 01-0333 For Lower Roots, Either Side
- 01-0433 For Lower Roots, Either Side

- 01-0533 For Lower Roots, Either Side, Slender Pattern
- 01-0633 For Lower Roots, Either Side, Slender Pattern
- 01-0641 For Upper Roots, Either Side
- 01-0644 For Upper Roots, Either Side
- 01-0645 For Lower Roots, Either Side
- 01-0651 For Upper Roots

**Extracting Forceps, English Pattern**  
 Zahnzangen, englische form  
 Forceps de extracción, forma inglesa  
 Daviers, forma anglaise  
 Pinze per estrazioni, forma inglese

**Extracting Forceps, English Pattern**  
 Zahnzangen, englische form  
 Forceps de extracción, forma inglesa  
 Daviers, forma anglaise  
 Pinze per estrazioni, forma inglese

All Extracting Dental Forceps are also available in **Non-Slip Grip Jaws**.  
 Please see page 11 for ordering details.

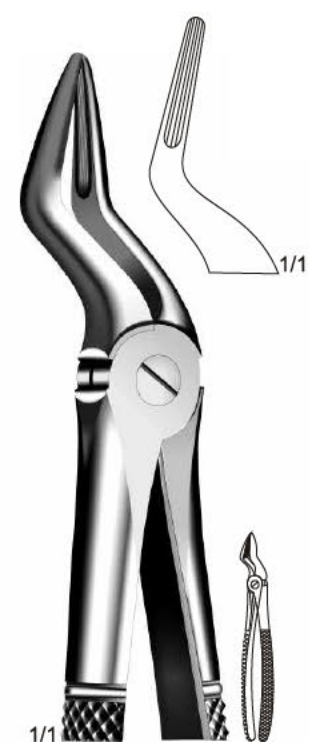

**01-0751**  
Fig. 51 A

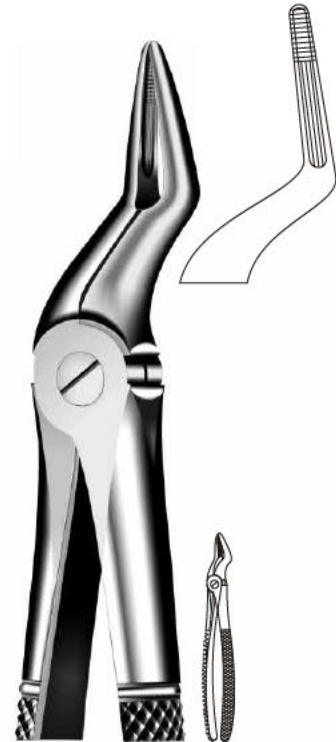

**01-0851**  
Fig. 51 C

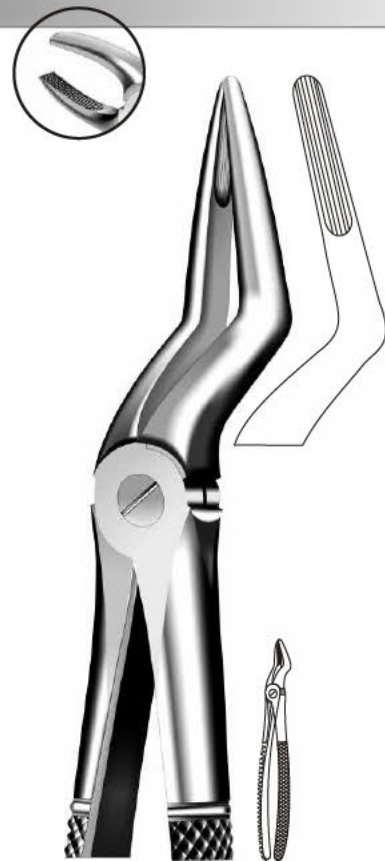

Mod. Pro  
**01-0951**  
Fig. 51 M

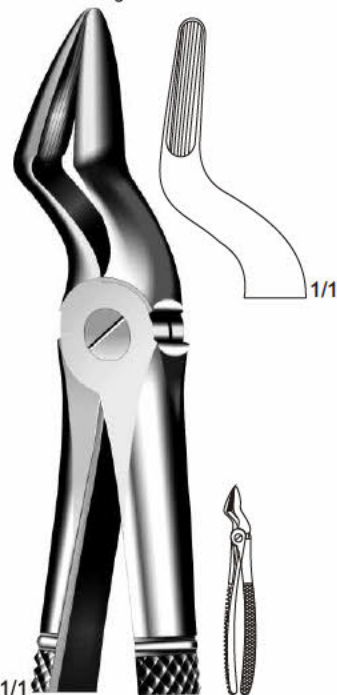

**01-0952**  
Fig. 52

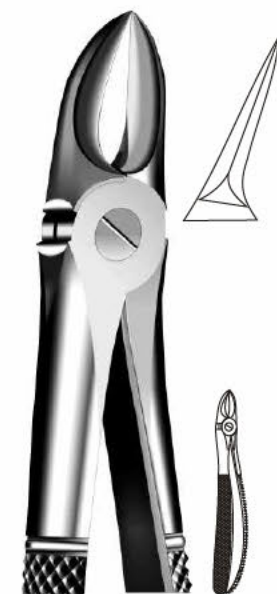

**01-0955**  
Fig. 55

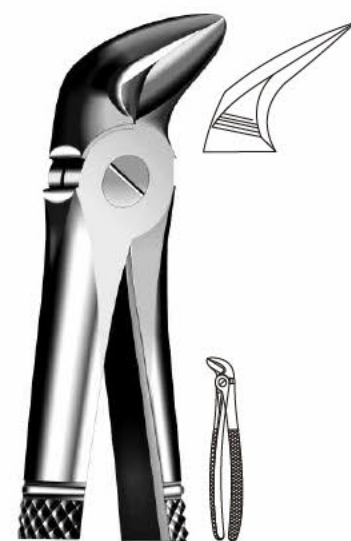

**01-0956**  
Fig. 56

- 01-0751 For Upper Roots, Very Narrow Beak
- 01-0851 For Upper Roots
- 01-0951 For Upper Roots With Very Long Beak For Deep Upper Roots
- 01-0952 For Upper Roots And Canines, With Wider Beak
- 01-0955 For Separating Upper Molar
- 01-0956 For Separating Lower Molar

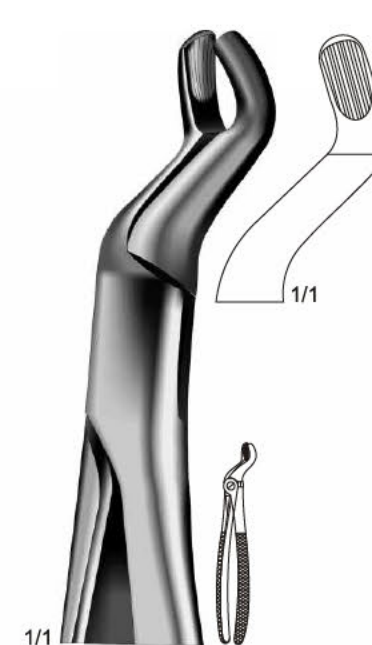

**01-0967**  
Fig. 67



**01-1067**  
Fig. 67 A



**01-1073**  
Fig. 73



**01-1074**  
Fig. 74



**01-1174**  
Fig. 74 M



**01-1274**  
Fig. 74 N



**01-1275**  
Fig. 75

- 01-0967 For Upper Wisdoms, Either Side
- 01-1067 For Upper Wisdoms, Either Side
- 01-1073 For Lower Molars, Either Side (Hawk's Bill)
- 01-1074 For Lower Incisors And Roots
- 01-1174 For Lower Incisors And Roots
- 01-1274 For Lower Incisors And Roots
- 01-1275 For Lower Bicuspid And Canines (either Side)

**Extracting Forceps, English Pattern**  
 Zahnzangen, englische form  
 Forceps de extracción, forma inglesa  
 Daviers, forma anglaise  
 Pinze per estrazioni, forma inglese

CH 01

www.surgical-i.com

All Extracting Dental Forceps are also available in Non-Slip Grip Jaws.  
 Please see page 11 for ordering details.

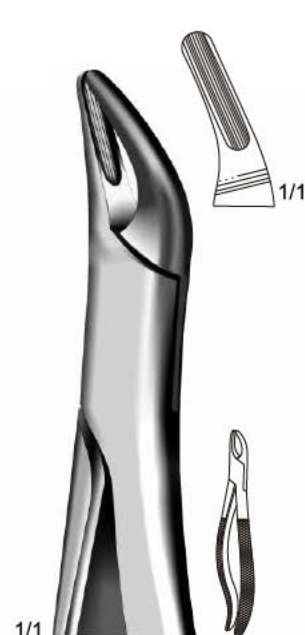

**Lowrence Read**  
**01-1276**  
 Fig. 76



**Lowrence Read**  
**01-1376**  
 Fig. 76 N



**01-1379**  
 Fig. 79

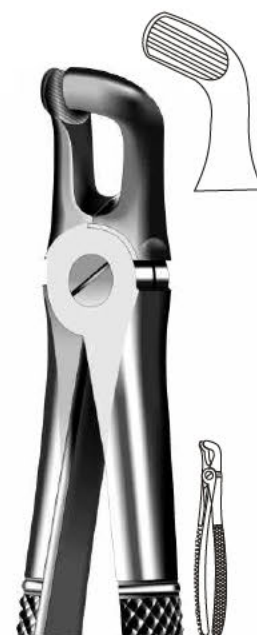

**01-1479**  
 Fig. 79 A

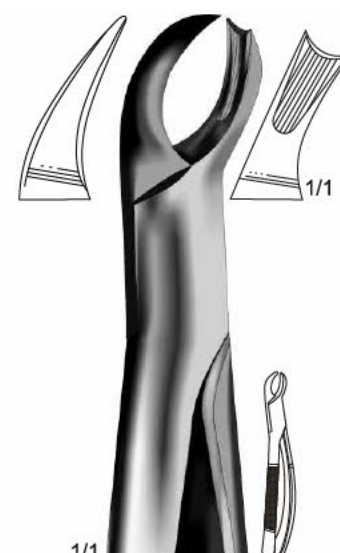

**01-1689**  
 Fig. 89



**01-1690**  
 Fig. 90



**01-1486**  
 Fig. 86 A



**01-1586**  
 Fig. 86 B



**01-1686**  
 Fig. 86 C

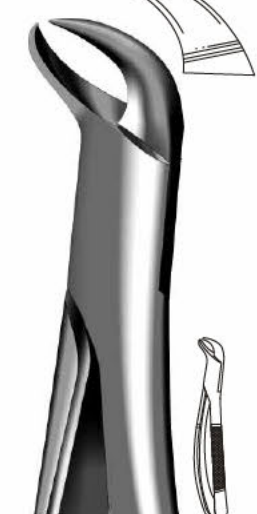

**01-1687**  
 Fig. 87



**01-1694**  
 Fig. 94

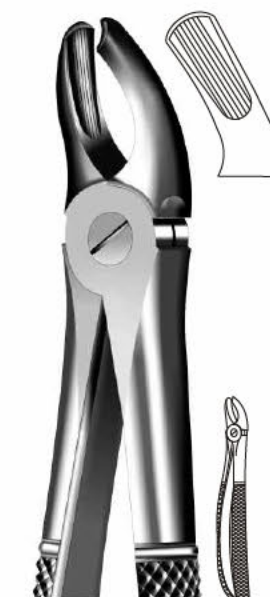

**01-1695**  
 Fig. 95



**01-1699**  
 Fig. 99

- 01-1276 For Upper Roots, Either Side
- 01-1376 For Upper Roots, Either Side (with Narrow Beak)
- 01-1379 For Lower Wisdoms (either Side)
- 01-1479 For Lower Wisdoms (either Side)
- 01-1486 For Lower Molar With Decayed Or Broken Down Crowns, Either Side
- 01-1586 For Lower Molar With Decayed Or Broken Down Crowns, Either Side
- 01-1686 For Lower Molar With Decayed Or Broken Down Crowns, Either Side
- 01-1687 For Lower Molar With Decayed Or Broken Down Crowns, Either Side

**Extracting Forceps, English Pattern**  
 Zahnzangen, englische form  
 Forceps de extracción, forma inglesa  
 Daviers, forma anglaise  
 Pinze per estrazioni, forma inglese

www.surgical-i.com

- 01-1689 For Right Upper Molars
- 01-1690 For Left Upper Molars
- 01-1694 For Right Upper Molars
- 01-1695 For Left Upper Molars
- 01-1699 For Broken Down Lower Molar

**Extracting Forceps, English Pattern**  
 Zahnzangen, englische form  
 Forceps de extracción, forma inglesa  
 Daviers, forma anglaise  
 Pinze per estrazioni, forma inglese

All Extracting Dental Forceps are also available in **Non-Slip Grip Jaws**.  
 Please see page next for ordering details.



1/1  
**Mead**  
**01-1701**  
 Fig. MD 1



**Mead**  
**01-1702**  
 Fig. MD 2

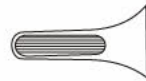

**Mead**  
**01-1703**  
 Fig. MD 3



**Mead**  
**01-1704**  
 Fig. MD 4

01-1701 Universal Forceps For Upper Wisdoms, Bicuspid And Upper Roots  
 01-1702 For Upper Molars  
 01-1703 For Lower Incisors, Bicuspid And Roots  
 01-1704 For Lower Molars

**Extracting Forceps with Alpha handle**  
 Zahnzangen mit Alfa-Griff  
 Fórceps de extracción con mango Alfa  
 Daviers Manche Alfa  
 Pinze per estrazioni, manico Alpha



**Alpha handle**

All preceding extracting forceps in English pattern are also available with **Alfa handle**.

Just replace first two article numbers, "01-" with "02-". Please refer to column "C" below.

Article numbers

A	B	C	A	B	C	A	B	C
Normal handle	Non-Slip Grip	Alfa handle	Normal handle	Non-Slip Grip	Alfa handle	Normal handle	Non-Slip Grip	Alfa handle
01-0101	01-0101 NS	02-0101	01-0333	01-0333 NS	02-0333	01-1376	01-1376 NS	02-1376
01-0102	01-0102 NS	02-0102	01-0433	01-0433 NS	02-0433	01-1379	01-1379 NS	02-1379
01-0104	01-0104 NS	02-0104	01-0533	01-0533 NS	02-0533	01-1479	01-1479 NS	02-1479
01-0107	01-0107 NS	02-0107	01-0633	01-0633 NS	02-0633	01-1486	01-1486 NS	02-1486
01-0108	01-0108 NS	02-0108	01-0641	01-0641 NS	02-0641	01-1586	01-1586 NS	02-1586
01-0113	01-0113 NS	02-0113	01-0644	01-0644 NS	02-0644	01-1686	01-1686 NS	02-1686
01-0117	01-0117 NS	02-0117	01-0645	01-0645 NS	02-0645	01-1687	01-1687 NS	02-1687
01-0118	01-0118 NS	02-0118	01-0651	01-0651 NS	02-0651	01-1689	01-1689 NS	02-1689
01-0218	01-0218 NS	02-0218	01-0751	01-0751 NS	02-0751	01-1690	01-1690 NS	02-1690
01-0219	01-0219 NS	02-0219	01-0851	01-0851 NS	02-0851	01-1694	01-1694 NS	02-1694
01-0220	01-0220 NS	02-0220	01-0951	01-0951 NS	02-0951	01-1695	01-1695 NS	02-1695
01-0221	01-0221 NS	02-0221	01-0952	01-0952 NS	02-0952	01-1699	01-1699 NS	02-1699
01-0222	01-0222 NS	02-0222	01-0955	01-0955 NS	02-0955	01-1701	01-1701 NS	02-1701
01-0223	01-0223 NS	02-0223	01-0956	01-0956 NS	02-0956	01-1702	01-1702 NS	02-1702
01-0224	01-0224 NS	02-0224	01-1074	01-1074 NS	02-1074	01-1703	01-1703 NS	02-1703
01-0229	01-0229 NS	02-0229	01-1174	01-1174 NS	02-1174	01-1704	01-1704 NS	02-1704
01-0329	01-0329 NS	02-0329	01-1274	01-1274 NS	02-1274			
01-0330	01-0330 NS	02-0330	01-1275	01-1275 NS	02-1275			
01-0331	01-0331 NS	02-0331	01-1276	01-1276 NS	02-1276			

**Non-Slip Grip Jaws**



All preceding extracting forceps in English pattern are also available in **Non-Slip Grip Jaws**.

Please add "NS" with existing article numbers. e.g **01-0101NS**. Please refer to column B.

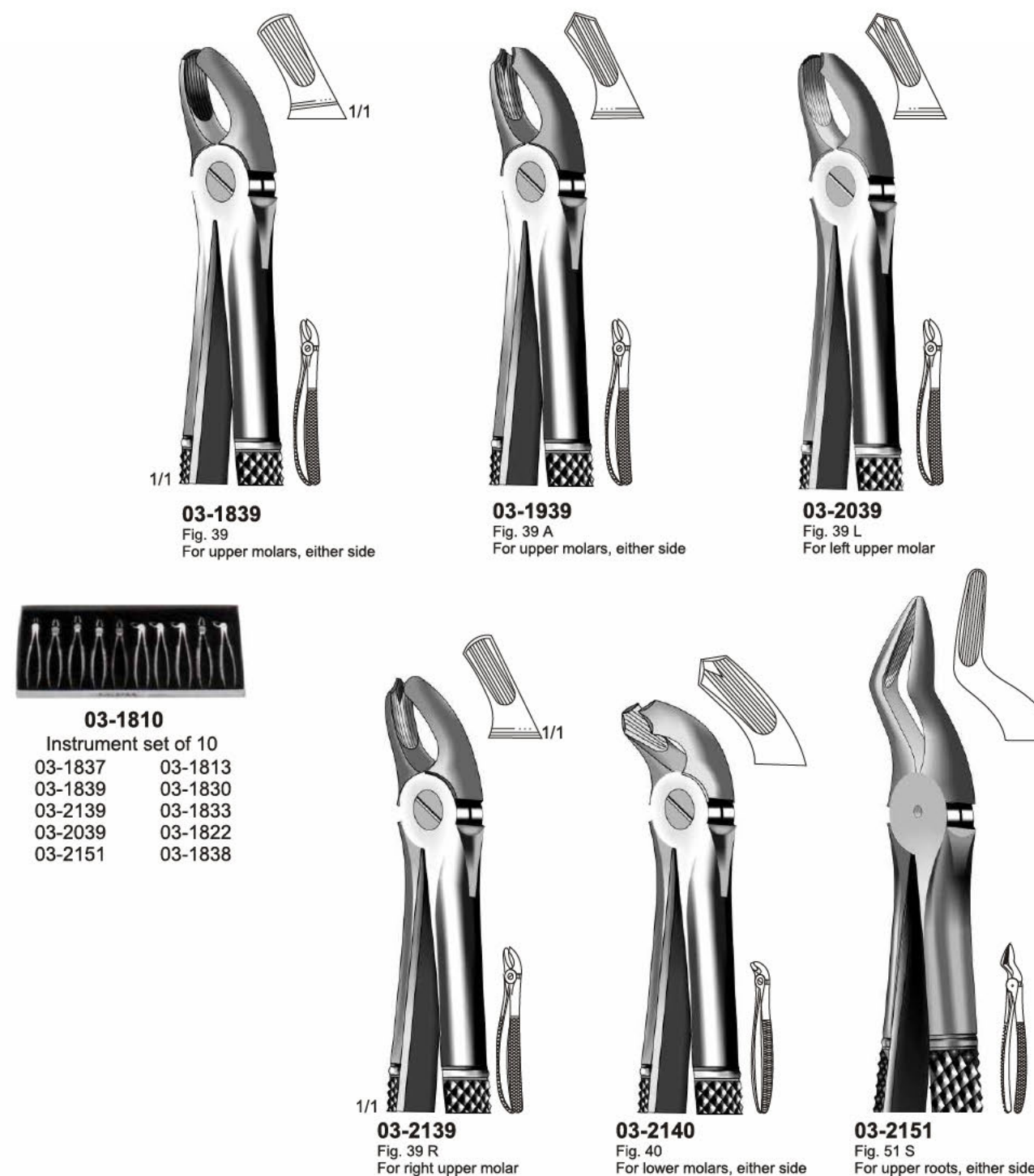



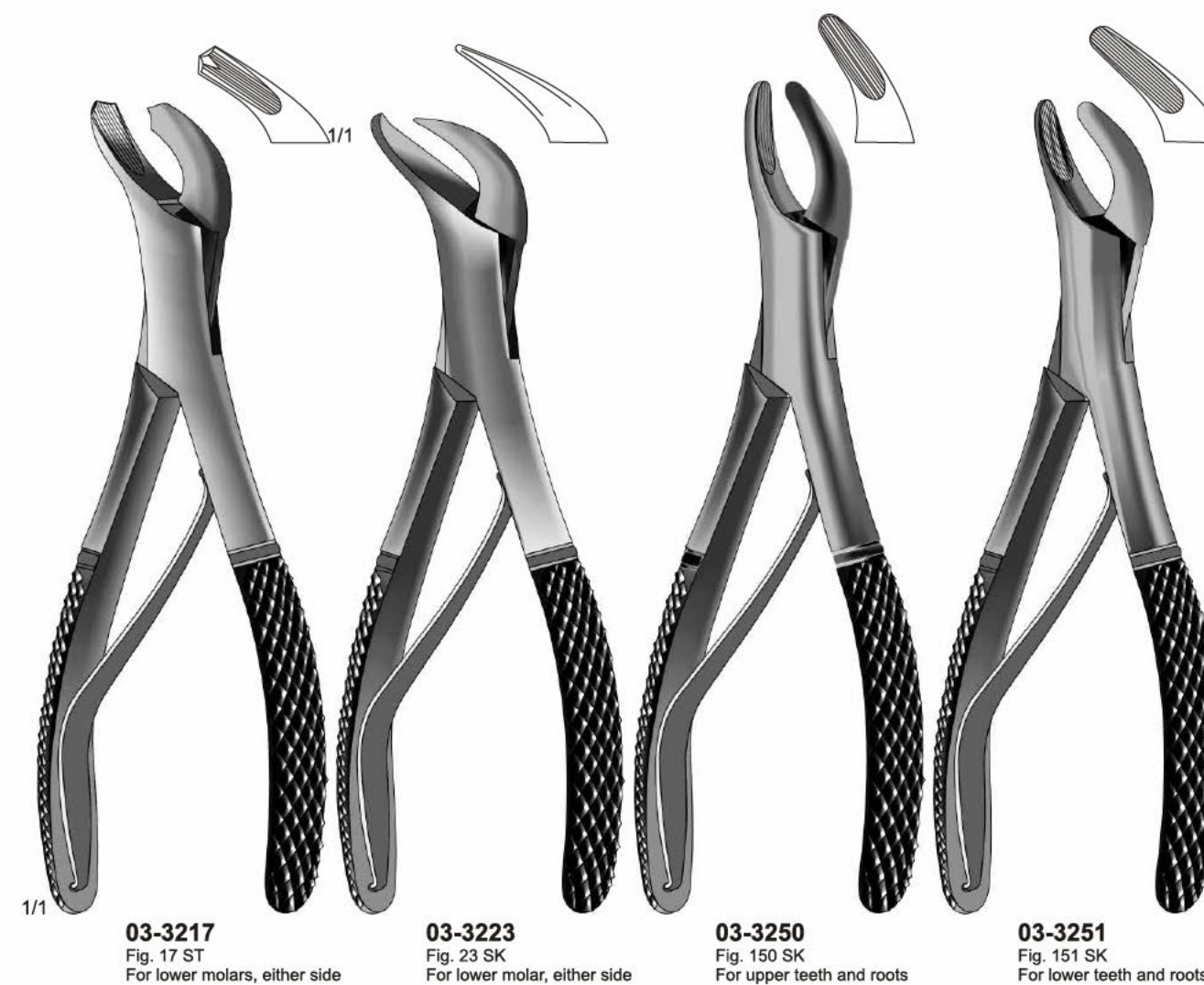
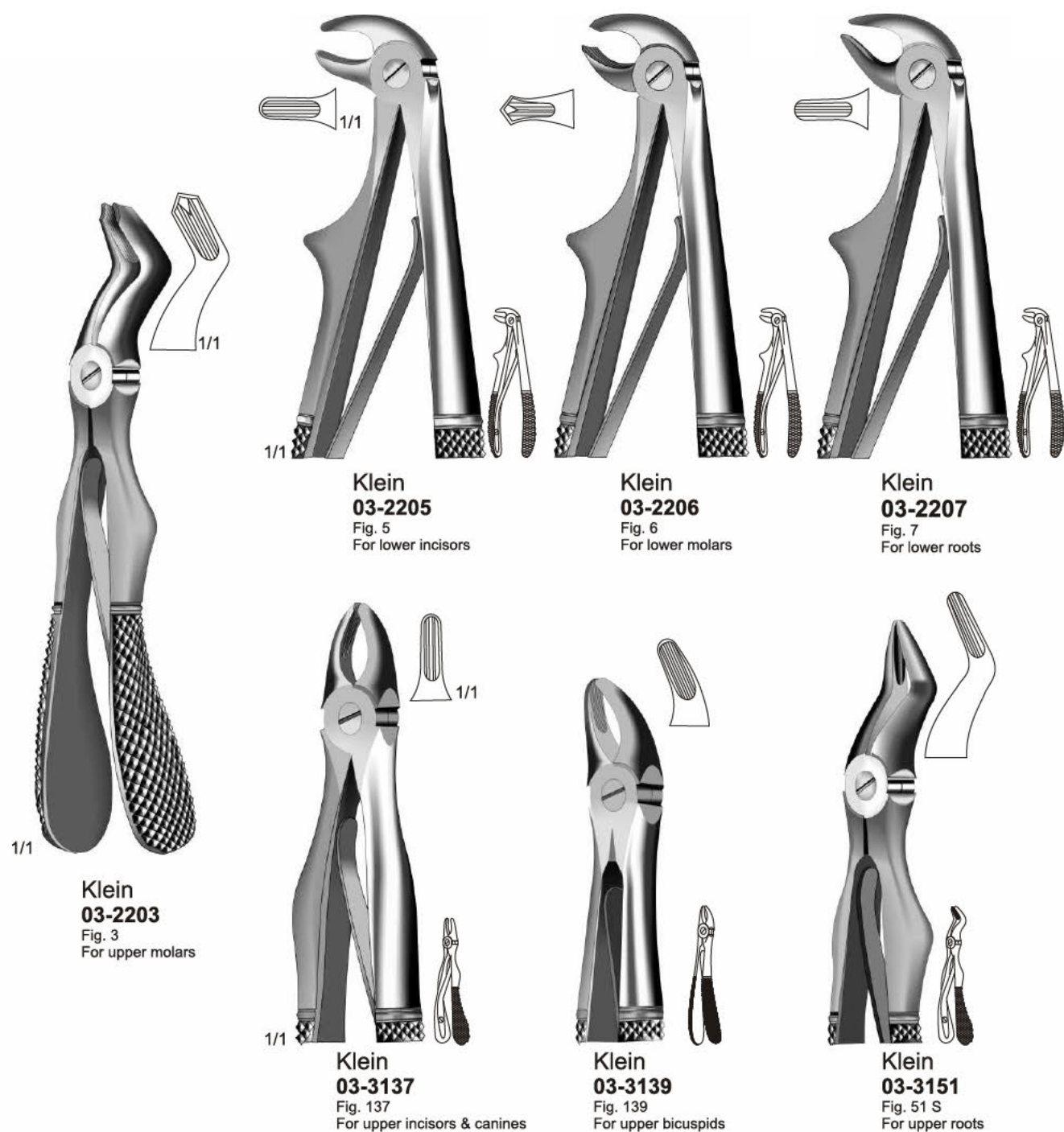

**Extracting Forceps, American Pattern**  
 Zahnzangen amerikanische Form  
 Fórceps de extracción forma americana  
 Daviers, Forme américain  
 Pinze per estrazioni, Forma americana



1/1  
**Standard**  
**04-0101**  
 Fig. 1  
 For upper centrals,  
 laterals and cuspids

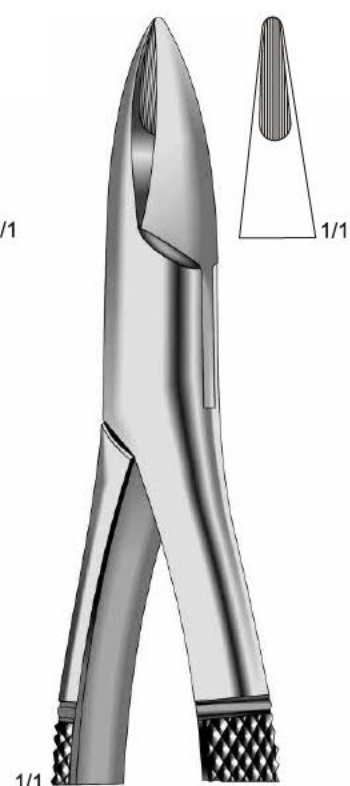

1/1  
**Henahan**  
**04-0201**  
 Fig. 1 A  
 For upper incisors



**Physick**  
**04-0205**  
 Fig. 5  
 For lower third molars  
 either side

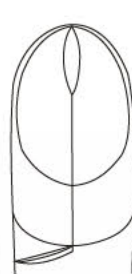

**04-0206**  
 Fig. 6  
 Splitting or separating  
 forceps

**Extracting Forceps, American Pattern**  
 Zahnzangen amerikanische Form  
 Fórceps de extracción forma americana  
 Daviers, Forme américain  
 Pinze per estrazioni, Forma americana

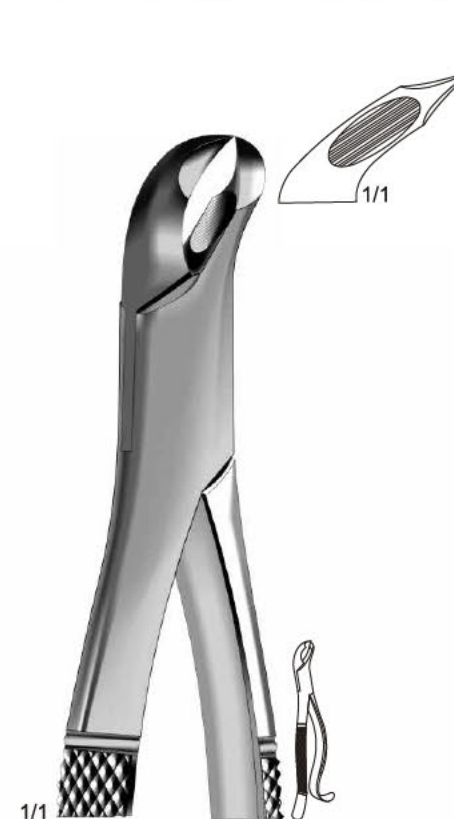

**Woodward**  
**04-0203**  
 Fig. 3 FH  
 For lower molars

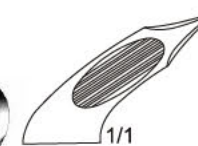

**04-0310 - 04-0410**  
 Fig. 10 H / Fig. 10 S  
 For upper molars, either side



**04-0310**  
 Fig. 10 H



**04-0410**  
 Fig. 10 S



**Harris**  
**04-0415**  
 Fig. 15



**04-0416**  
 Fig. 16  
 For lower molars

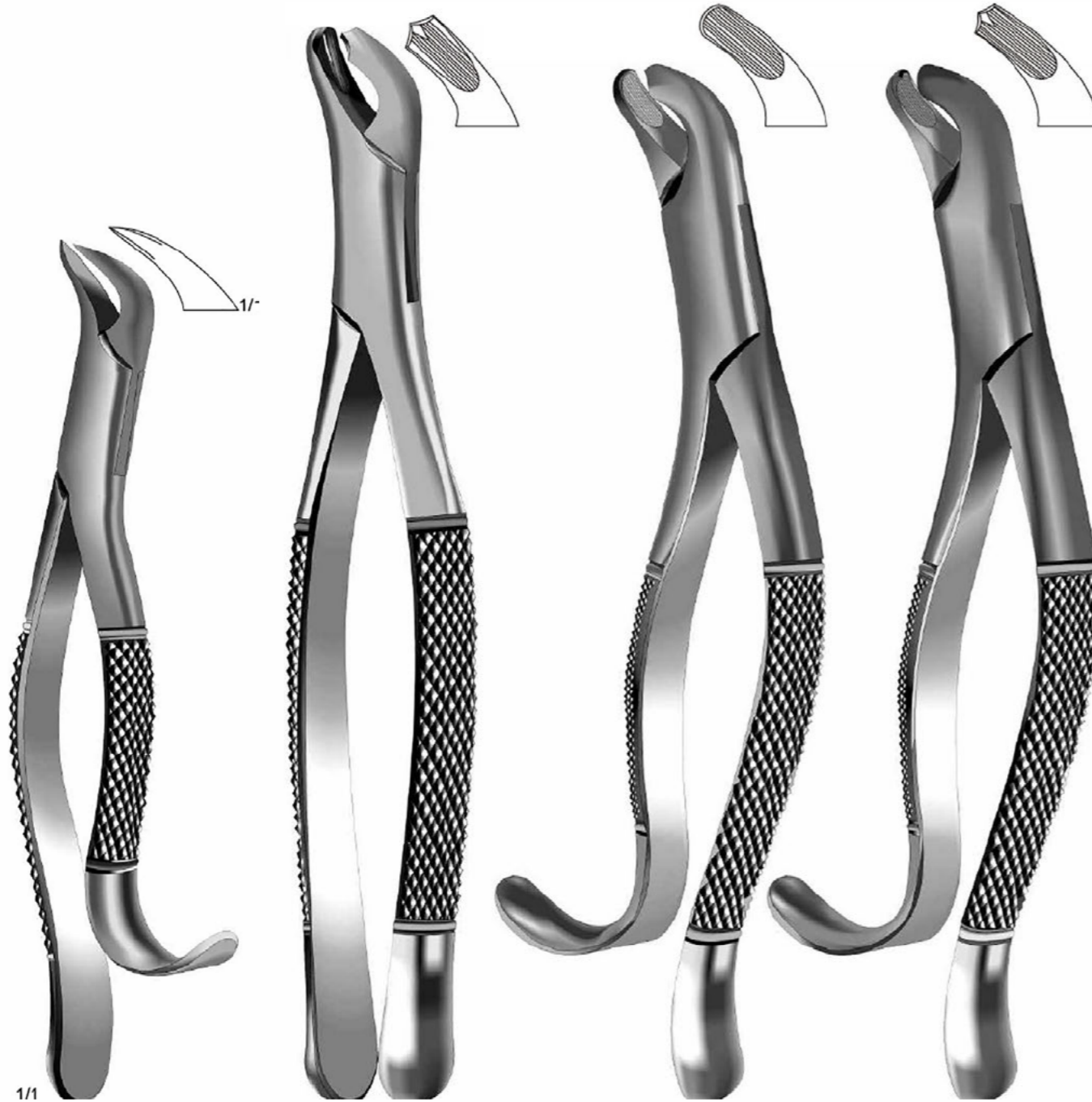

**04-0516**  
Fig. 16 S

**04-0517**  
Fig. 17

**Harris  
04-0618**  
Fig. 18 L

**Harris  
04-0718**  
Fig. 18 R

04-0516 For Lower Molars, Either Side, For Children  
 04-0517 For Lower Molars, Either Side  
 04-0618 For Upper Molars, Left Side  
 04-0718 For Upper Molars, Right Side

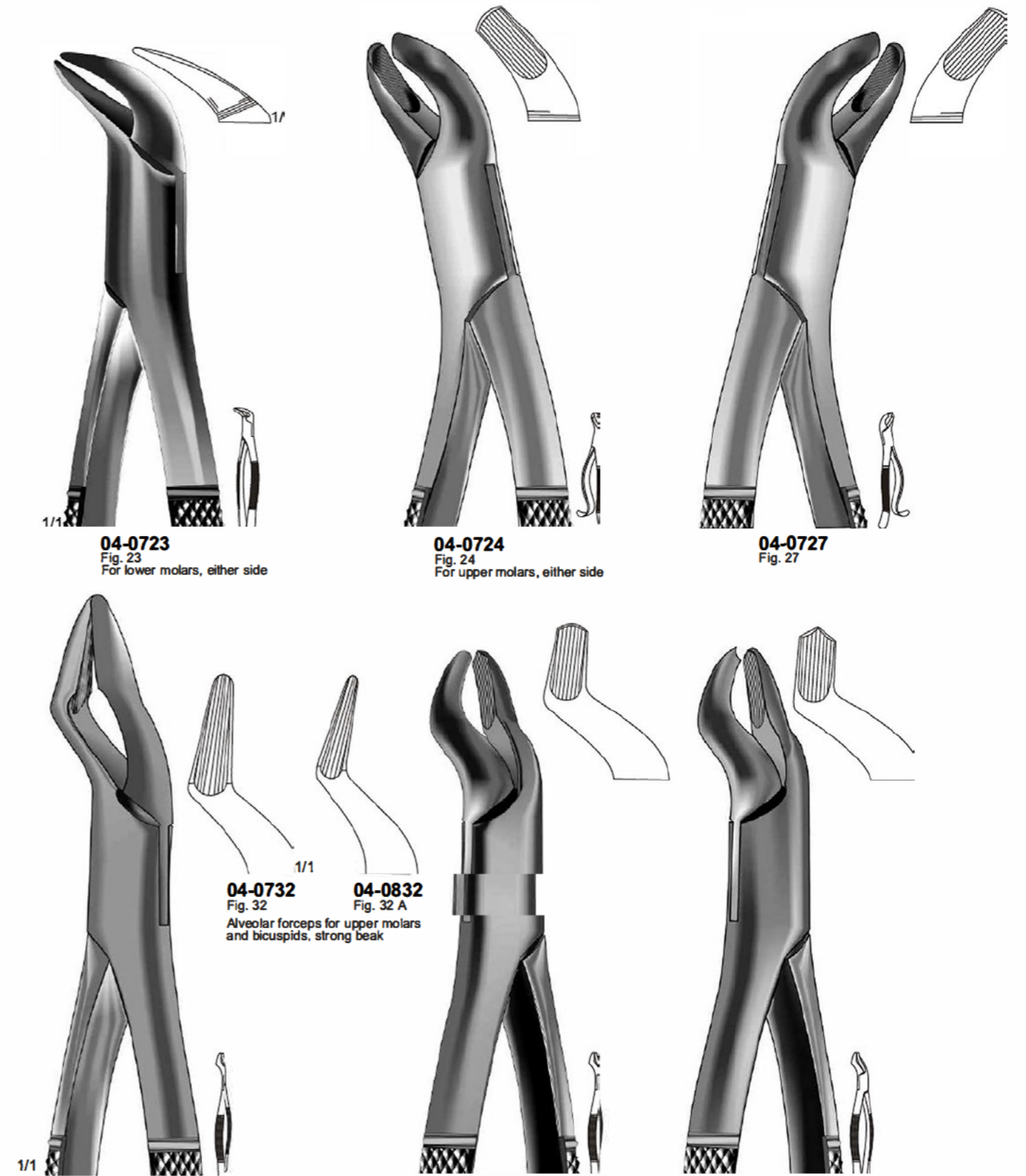

**04-0723**  
Fig. 23  
For lower molars, either side

**04-0724**  
Fig. 24  
For upper molars, either side

**04-0727**  
Fig. 27

**04-0732**  
Fig. 32  
Alveolar forceps for upper molars  
and bicusps, strong beak

**04-0832**  
Fig. 32 A

**Parmly  
04-0732 - 04-0832**

**04-0853**  
Fig. 53 L  
For upper  
molars left side

**04-0953**  
Fig. 53 R  
For upper  
molars right side

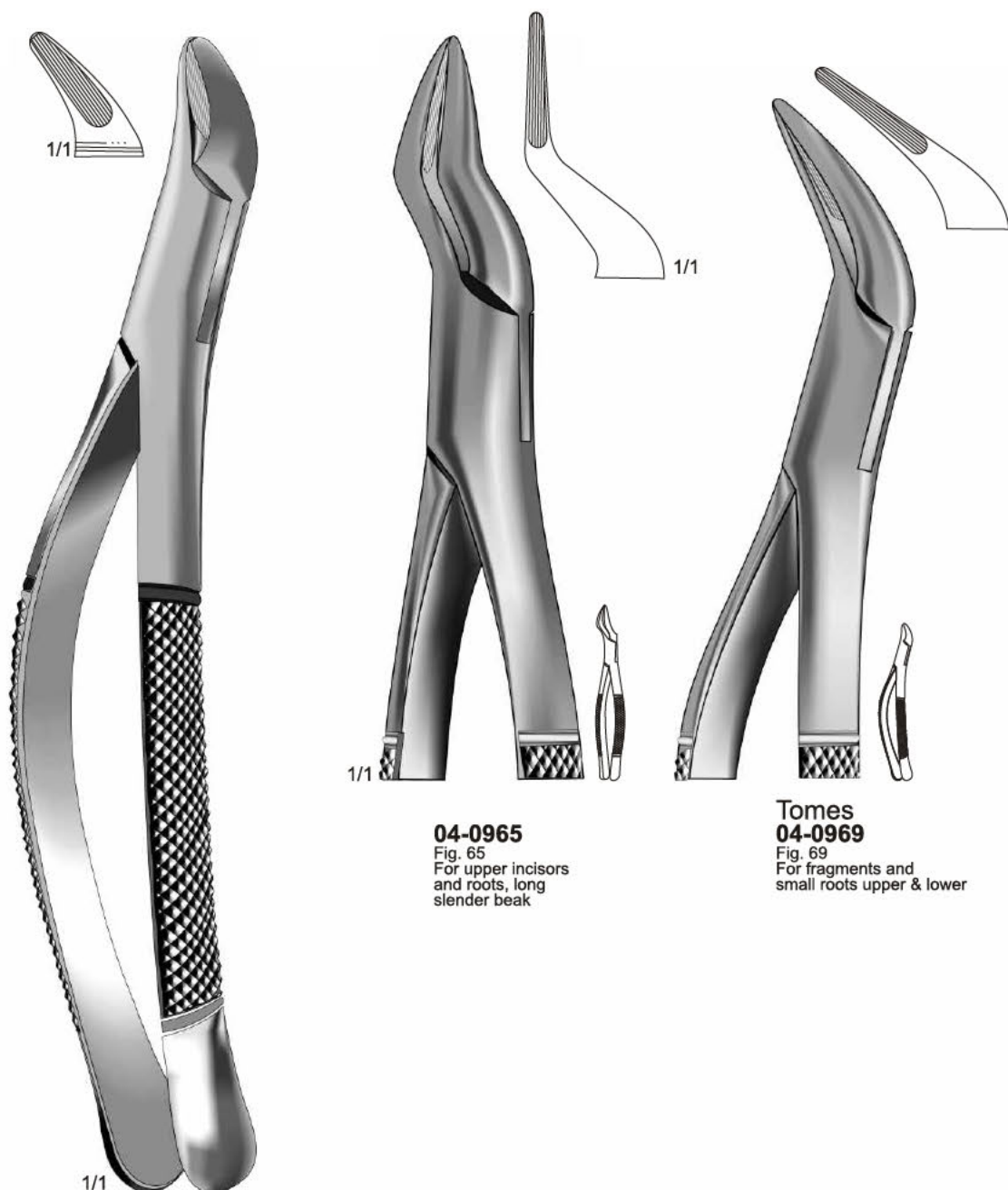

**04-0962**  
 Fig. 62  
 Universal forceps for upper  
 teeth & roots, also for children

**04-0965**  
 Fig. 65  
 For upper incisors  
 and roots, long  
 slender beak

**Tomes**  
**04-0969**  
 Fig. 69  
 For fragments and  
 small roots upper & lower

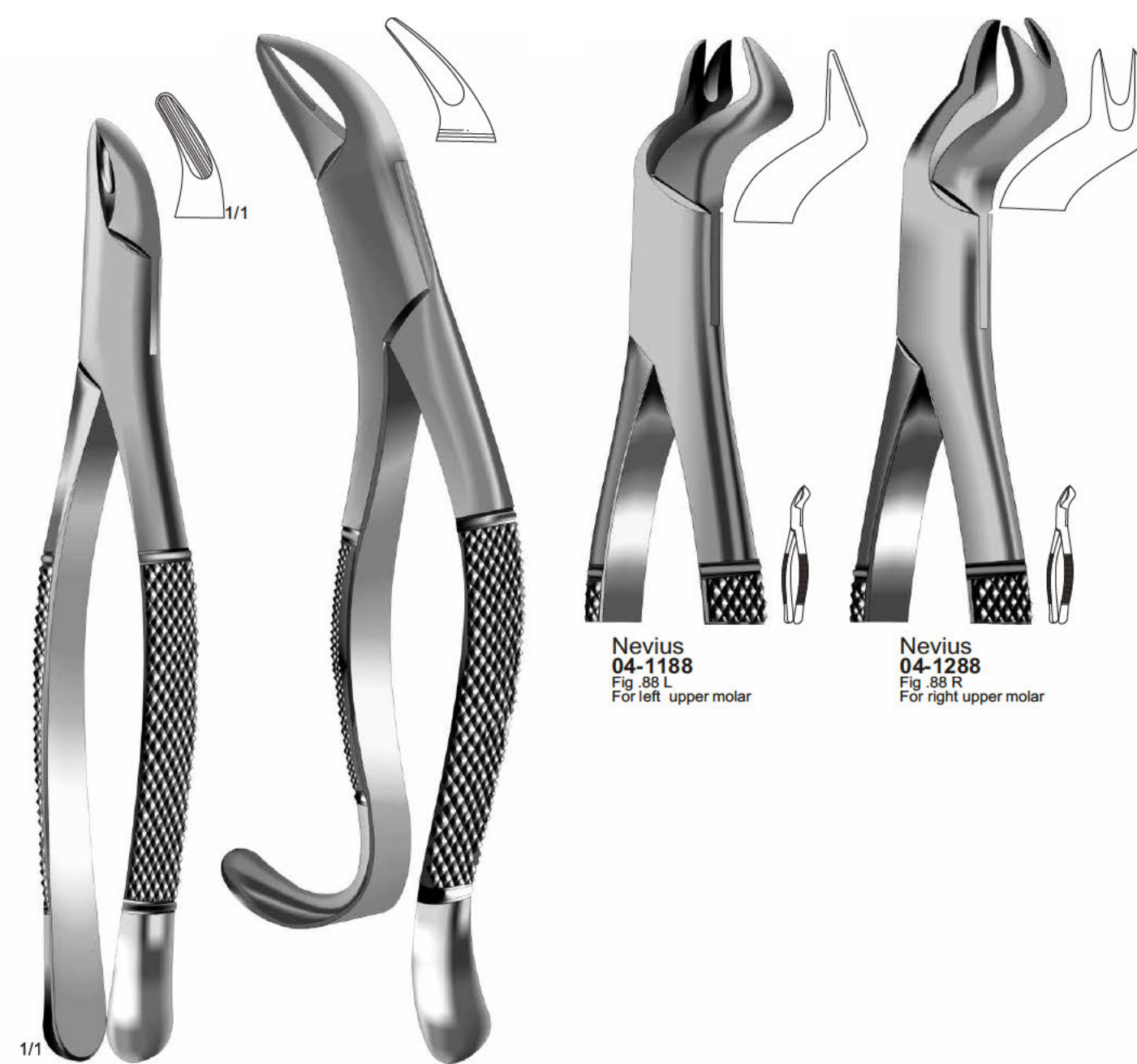

**Hull**  
**04-1101**  
 Fig. 101  
 Universal forceps for  
 bicuspid and milk teeth

**04-1103**  
 Fig. 103  
 For lower bicuspid  
 incisors, roots, either side

**Nevius**  
**04-1188**  
 Fig. 88 L  
 For left upper molar

**Nevius**  
**04-1288**  
 Fig. 88 R  
 For right upper molar

**Extracting Forceps, American Pattern**  
 Zahnzangen amerikanische Form  
 Fórceps de extracción forma americana  
 Daviers, Forme américain  
 Pinze per estrazioni, Forma americana



**Kells**  
**04-1299**  
 Fig. 99 A  
 For upper bicuspid,  
 cuspid and incisors



**Kells**  
**04-1399**  
 Fig. 99 C  
 For upper bicuspid,  
 cuspid and incisors



**Nevius**  
**04-2110**  
 Fig. 110  
 For upper cuspid and bicuspid



**Nevius**  
**04-3110**  
 Fig. 110  
 For upper cuspid and bicuspid

**Extracting Forceps, American Pattern**  
 Zahnzangen amerikanische Form  
 Fórceps de extracción forma americana  
 Daviers, Forme américain  
 Pinze per estrazioni, Forma americana



**Cryer**  
**04-4150**  
 Fig. 150



**Cryer**  
**04-5150**  
 Fig. 150 A



**Cryer**  
**04-6150**  
 Fig. 150 S



**Cryer**  
**04-6151**  
 Fig. 151



**Cryer**  
**04-7151**  
 Fig. 151 A



**Cryer**  
**04-8151**  
 Fig. 151 S

04-4150 For Upper Bicuspid, Incisors And Roots  
 04-5150 For Upper Bicuspid, Incisors And Roots (but Modified)  
 04-6150 For Upper Bicuspid, Incisors And Roots  
 04-6151 For Lower Bicuspid, Incisors And Roots  
 04-7151 For Lower Bicuspid, Incisors And Roots  
 04-8151 For Lower Bicuspid, Incisors And Roots

Extracting Forceps, American Pattern  
 Zahnzangen amerikanische Form  
 Fórceps de extracción forma americana  
 Daviers, Forme américain  
 Pinze per estrazioni, Forma americana

CH 04

www.surgical-i.com

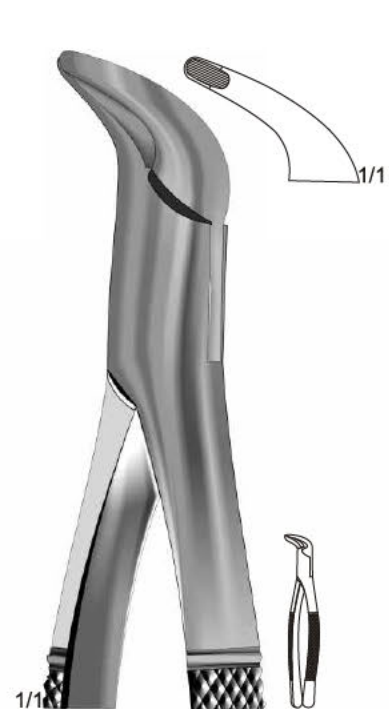

04-8203  
Fig. 203

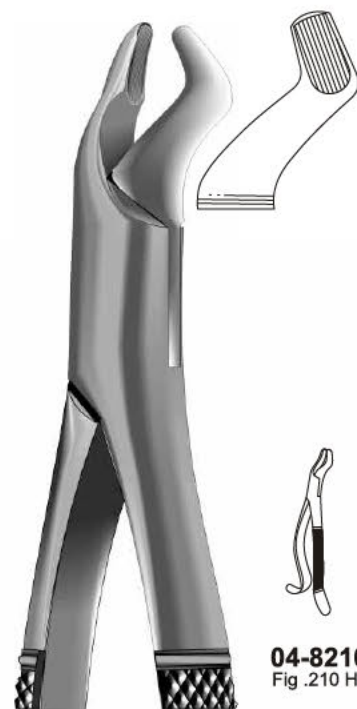

04-8210 - 04-9210



04-8210  
Fig. 210 H



04-9210  
Fig. 210 S



04-9217  
Fig. 217

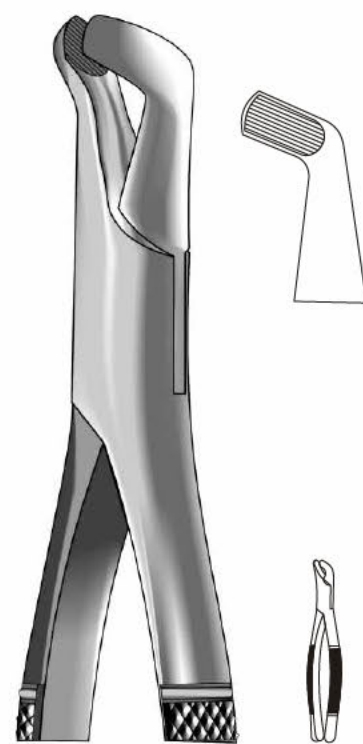

04-9222  
Fig. 222

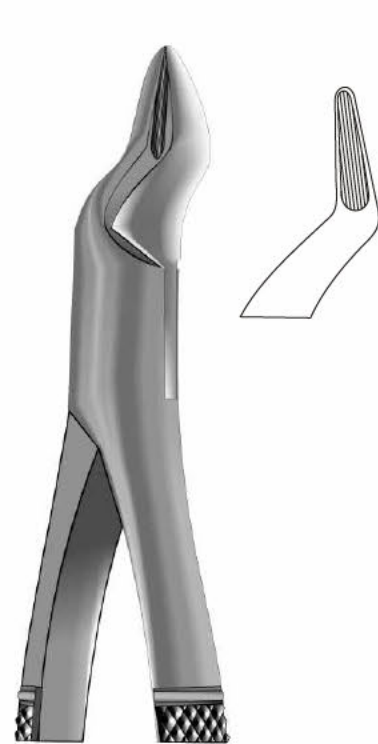

04-9286  
Fig. 286

- 04 8203 For lower bicuspid, incisors and roots, either side
- 04 8210 For upper wisdoms, either side
- 04 9210 For upper wisdoms, either side
- 04 9217 For lower molars, either side
- 04 9222 For lower wisdoms, either side
- 04 9286 For upper roots, bicuspid and incisors, either side

# CH 05

Root Elevators  
 Wurzelheber  
 Elevadores para raíces  
 Élévateurs à racines  
 Leve per radici





### Choice of Handles for Root Elevators.

If you wish to order a different type (A, B, C, D, E, F and G) of handle for a particular product, please mention **that** type with the code number of that product.

**Example : 05-0701E**

If you wish to order a particular type (A, B, C, D, E, F and G) of handle with all instruments, please mention **that** type in your purchase order.

**Example : Please use handle C for all Scalers.**



A

B



C

D

E

F

G

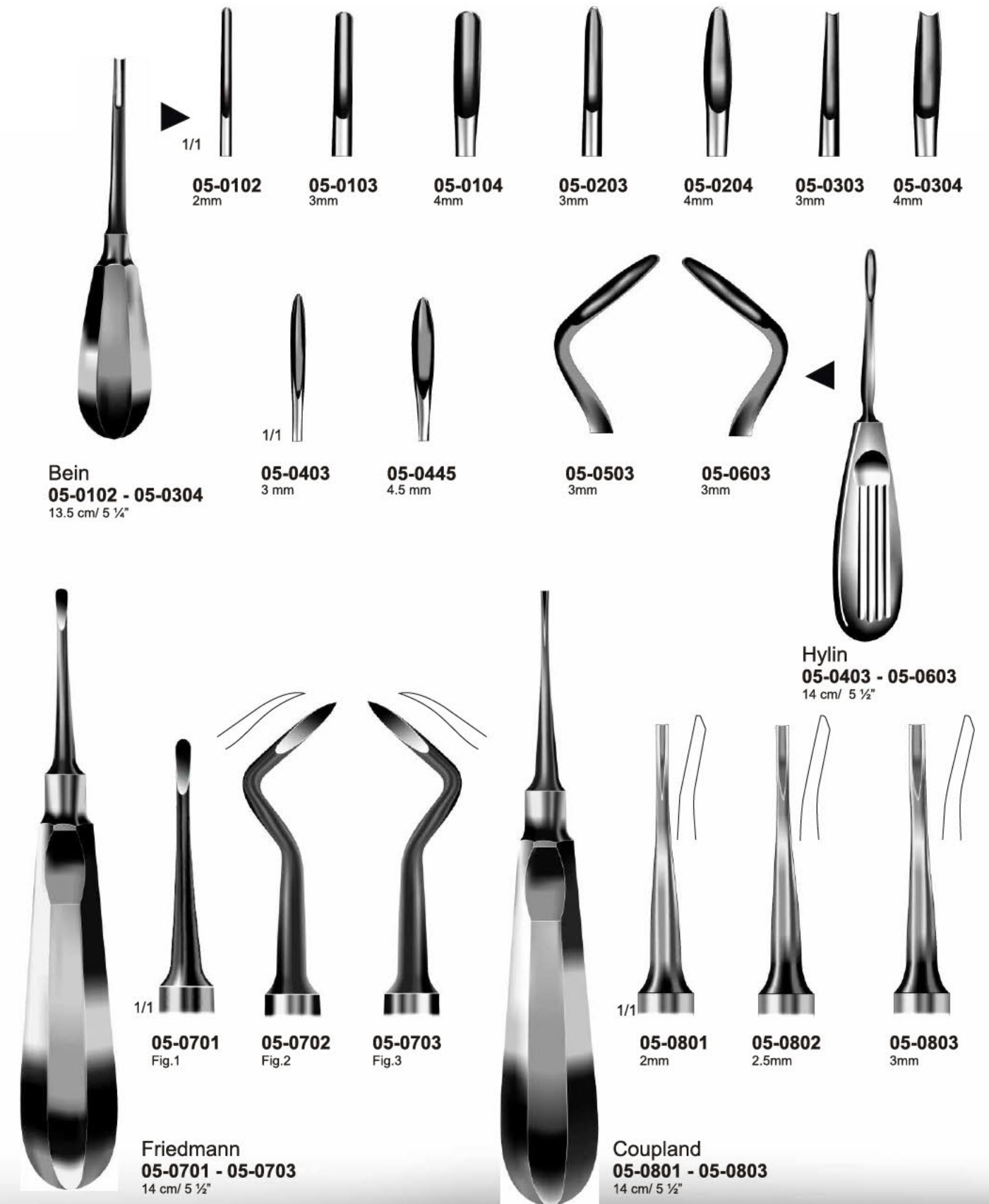

Bein  
05-0102 - 05-0304  
13.5 cm/ 5 1/4"

05-0403  
3 mm

05-0445  
4.5 mm

05-0503  
3mm

05-0603  
3mm

Hylin  
05-0403 - 05-0603  
14 cm/ 5 1/2"

05-0701  
Fig.1

05-0702  
Fig.2

05-0703  
Fig.3

Friedmann  
05-0701 - 05-0703  
14 cm/ 5 1/2"

05-0801  
2mm

05-0802  
2.5mm

05-0803  
3mm

Coupland  
05-0801 - 05-0803  
14 cm/ 5 1/2"

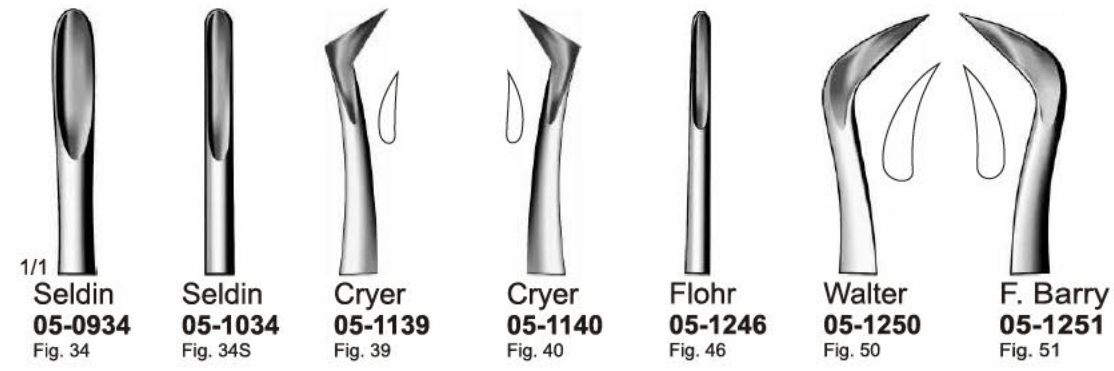

**05-0934 - 05-2304**  
 13.5 cm/ 5 1/2"

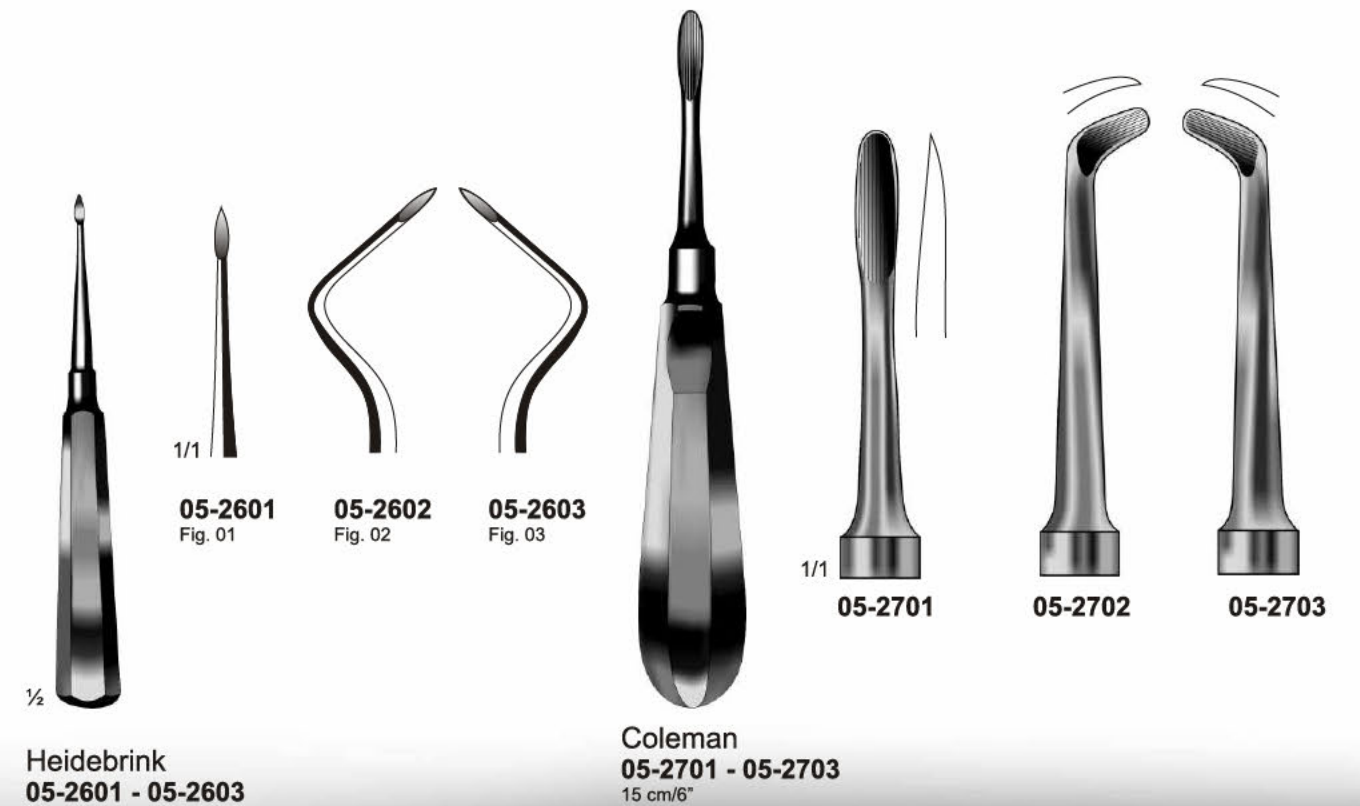
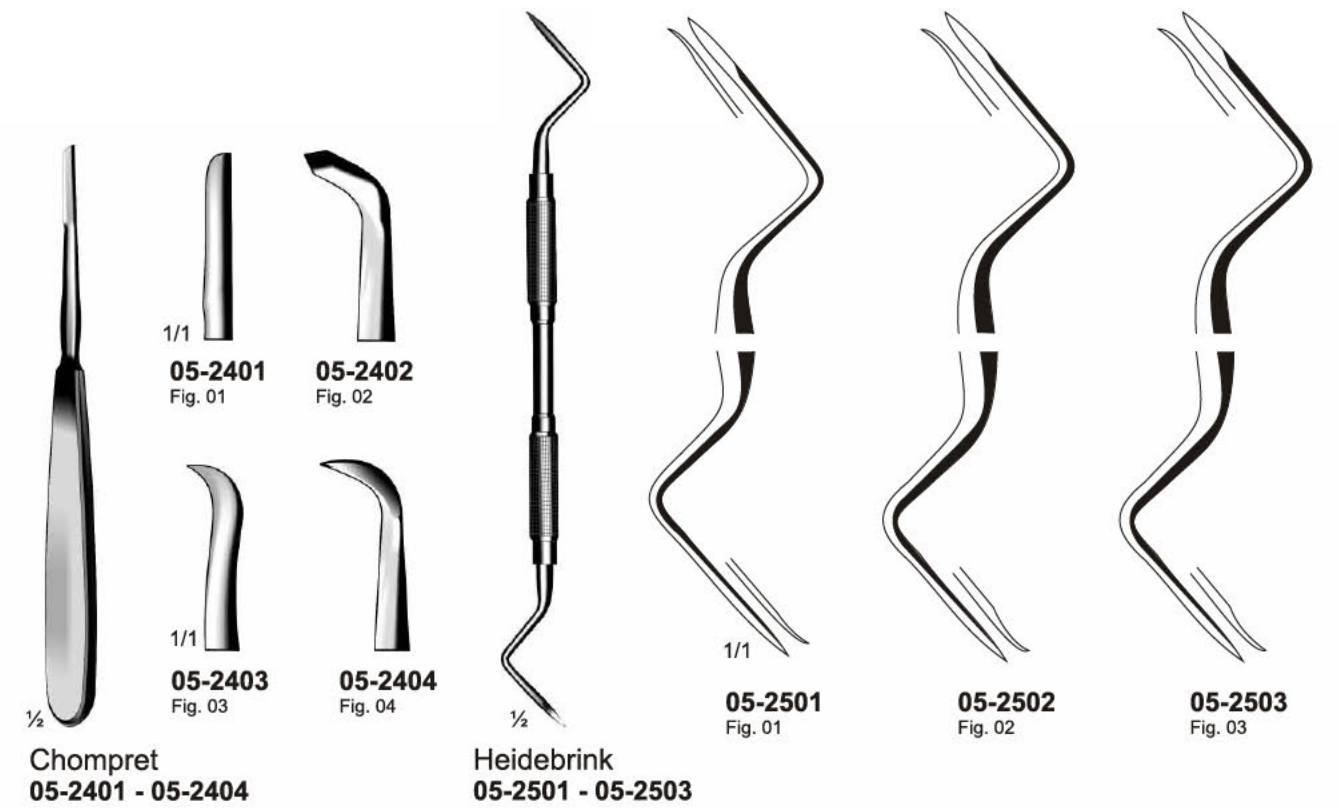



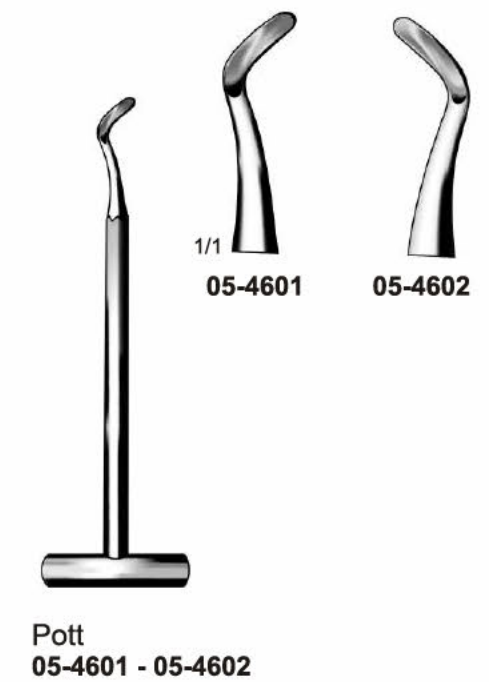
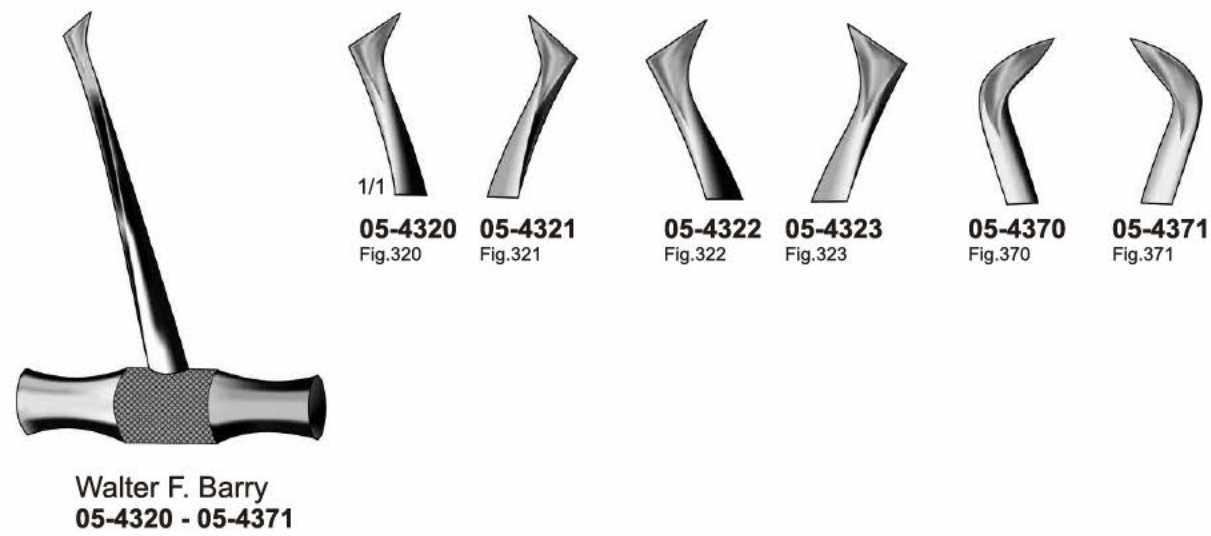
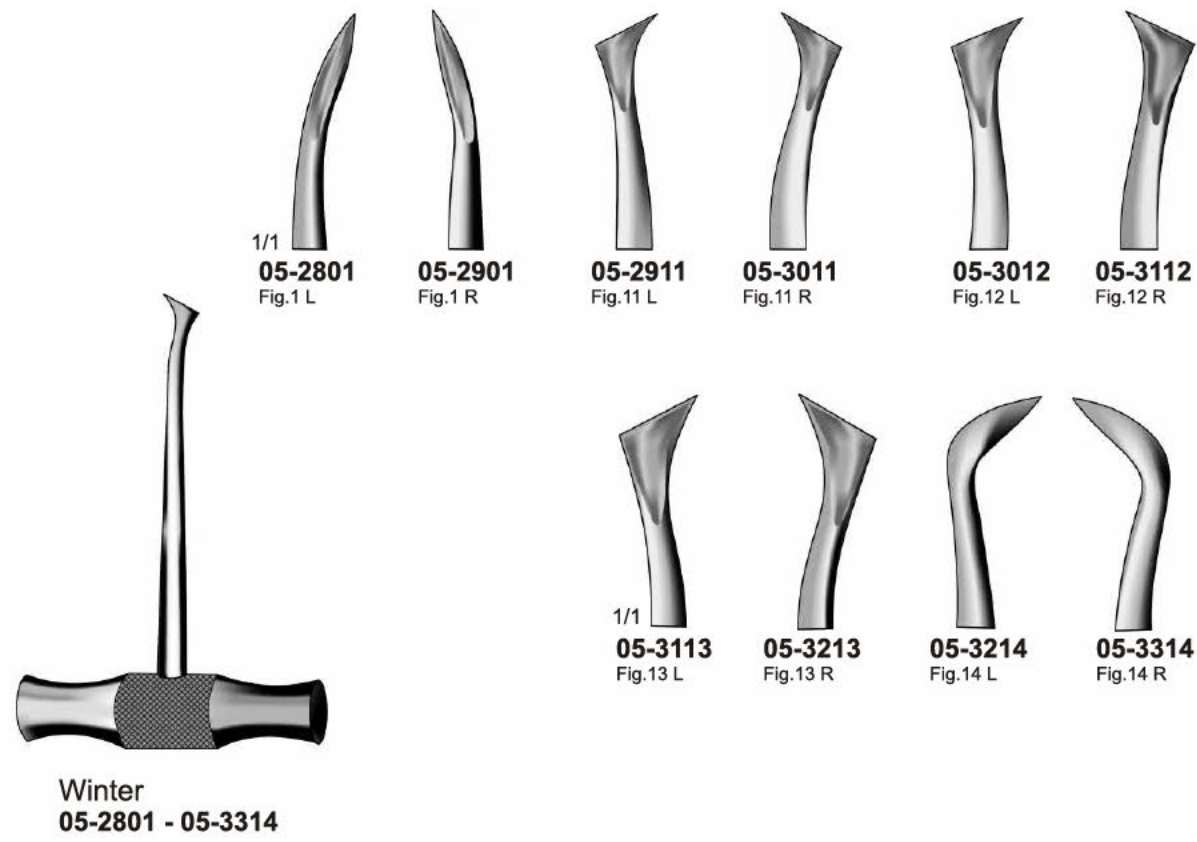

Root Elevators  
 Wurzelheber  
 Elevadores para raíces  
 Elévateurs à racines  
 Leve per radici

CH 05

www.surgical-i.com



West 05-4723 Fig 2/3  
 West 05-4756 Fig. 5/6  
 Warwick-James 05-4801 16 cm/ 6 1/4"  
 Warwick-James 05-4802 16 cm/ 6 1/4"  
 Warwick-James 05-4803 16 cm/ 6 1/4"  
 Walter F. Barry 05-4904 - 05-4906

# CH 06

Amalgam Instruments  
 Amalgaminstrumente  
 Instrumentos para amalgama  
 Instruments à amalgame  
 Strumenti per amalgma





**Choice of Handles for Scalers, Amalgam Instruments, Filling Instruments, Curettes, Probes, Knives, Explorers and Excavators**

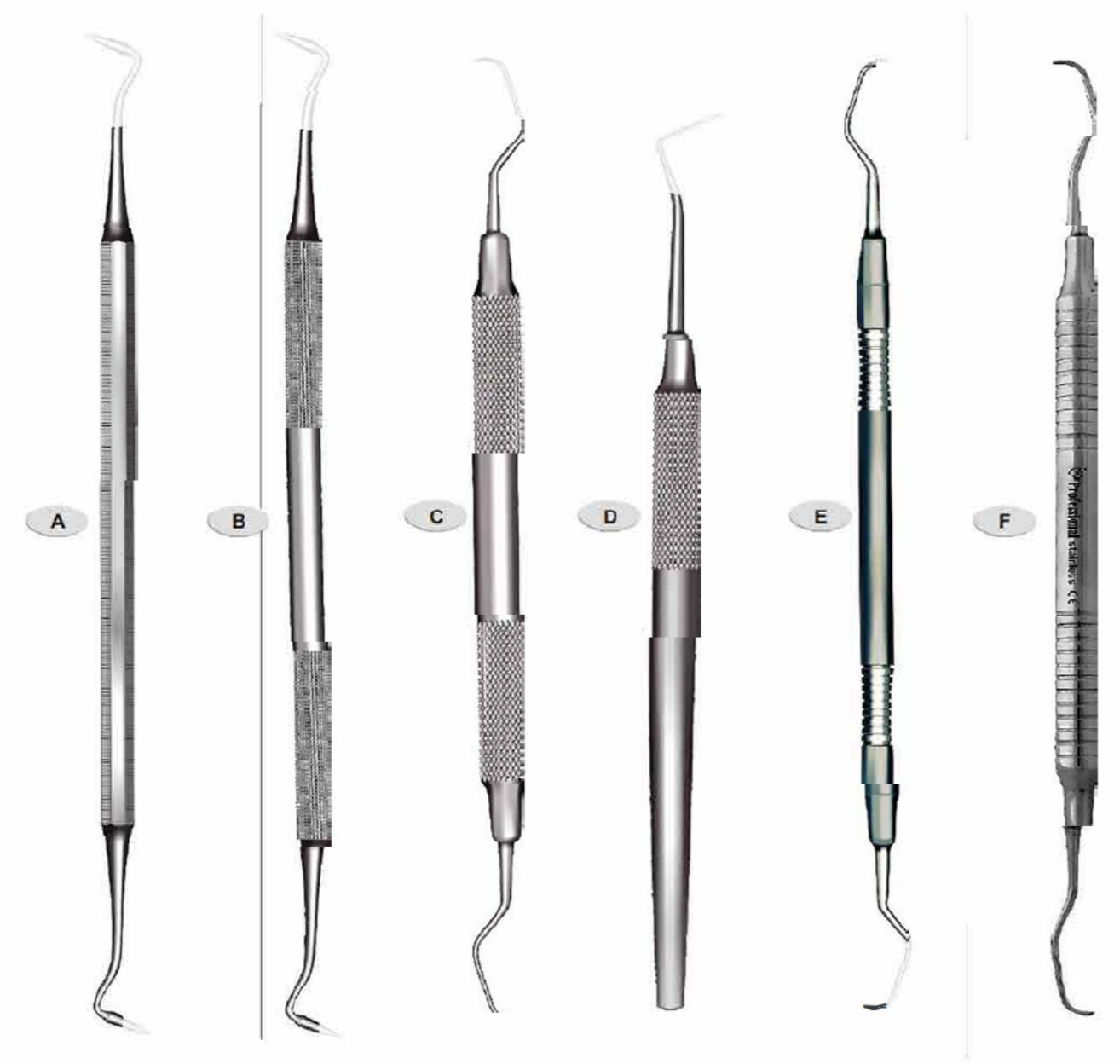

If you wish to order a different type (A, B, C, D, E and F) of handle for a particular products, please mention that type with the code number of that product.

**Example : 06-1001C**

If you wish to order a particular type (A, B, C, D, E and F) of handle with all instruments, please mention that type in your purchase order.

**Example : Please use handle C for all Scalers.**

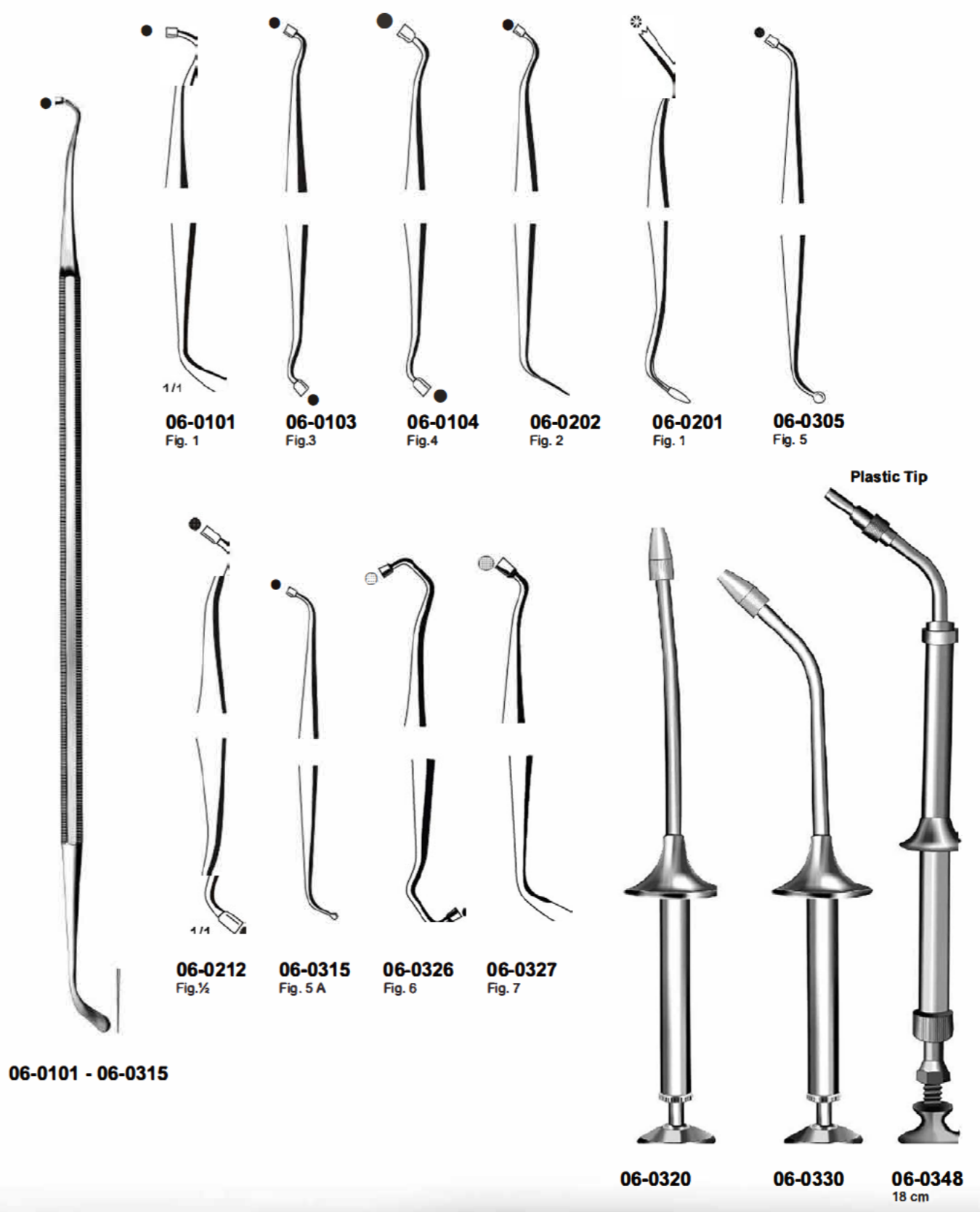



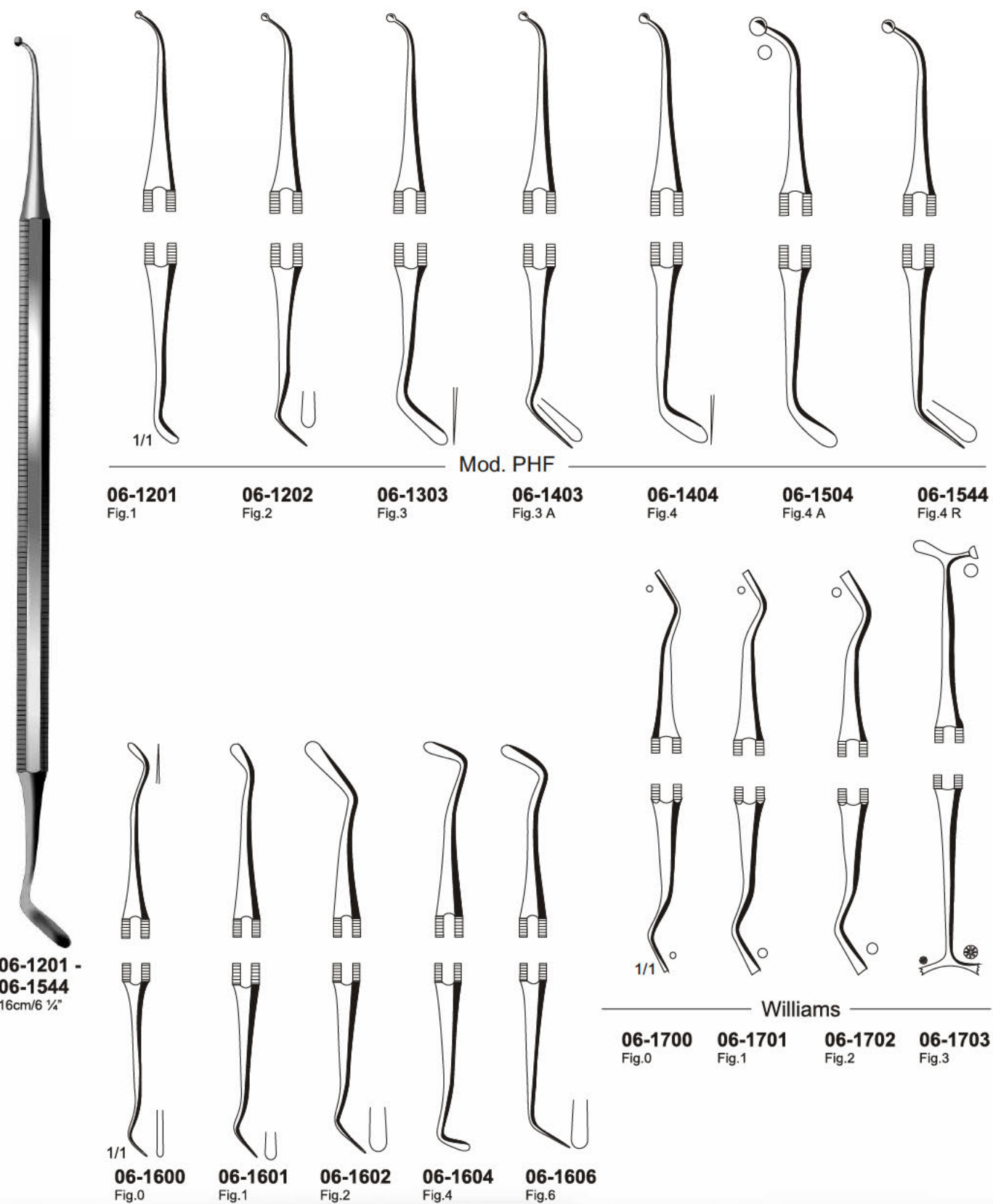

Please see page 34 for different handle styles.

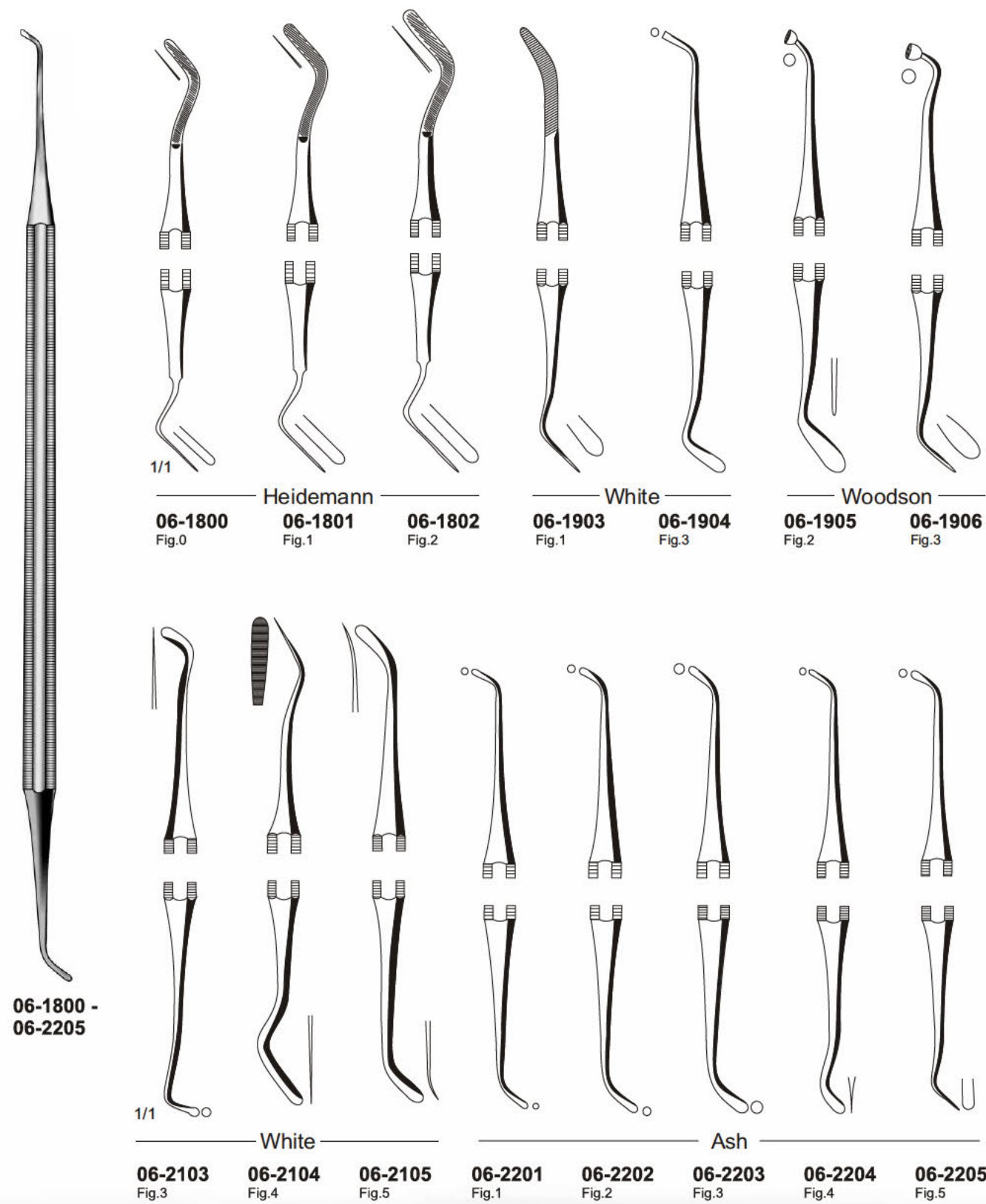

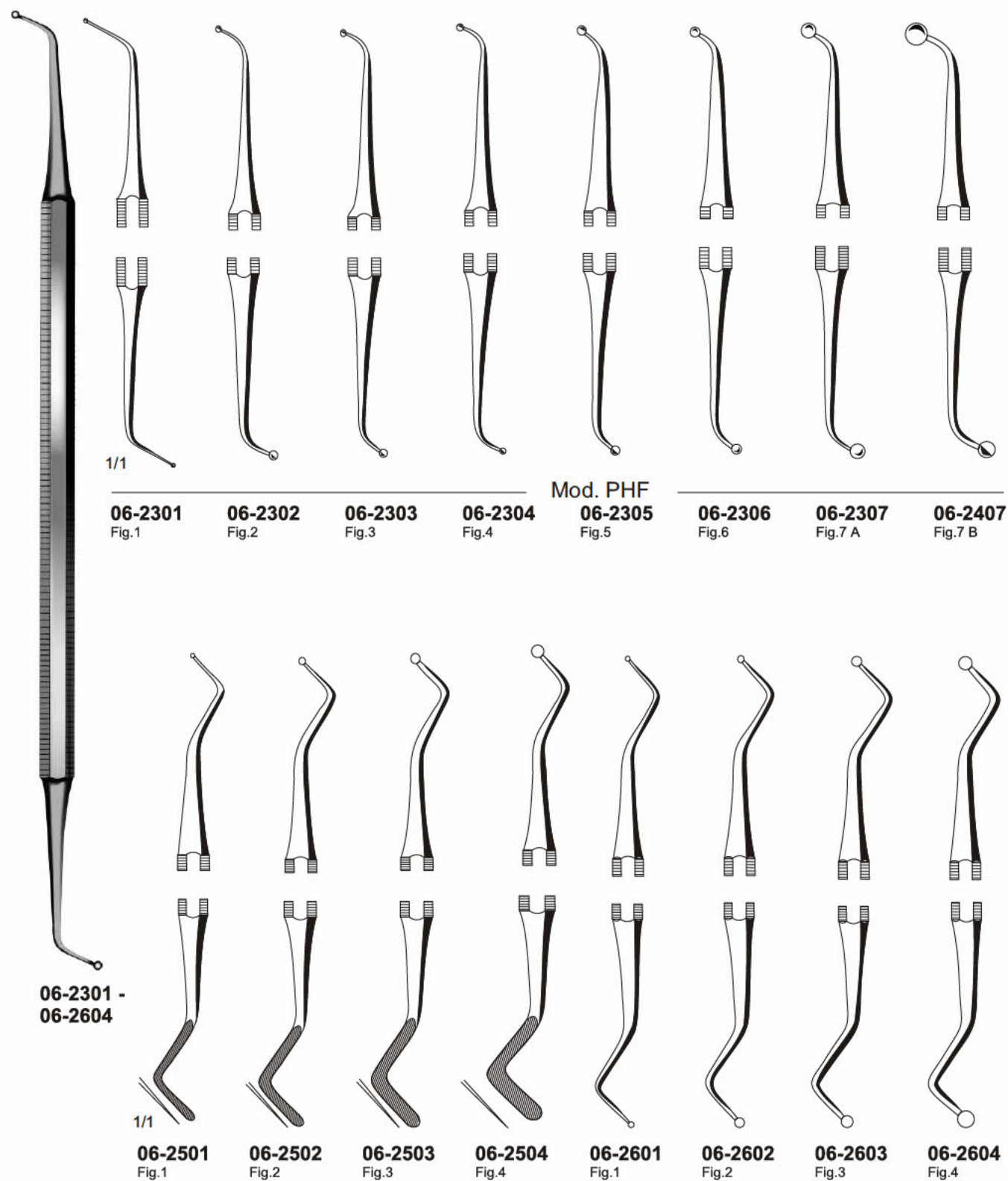

Please see page 34 for different handle styles.

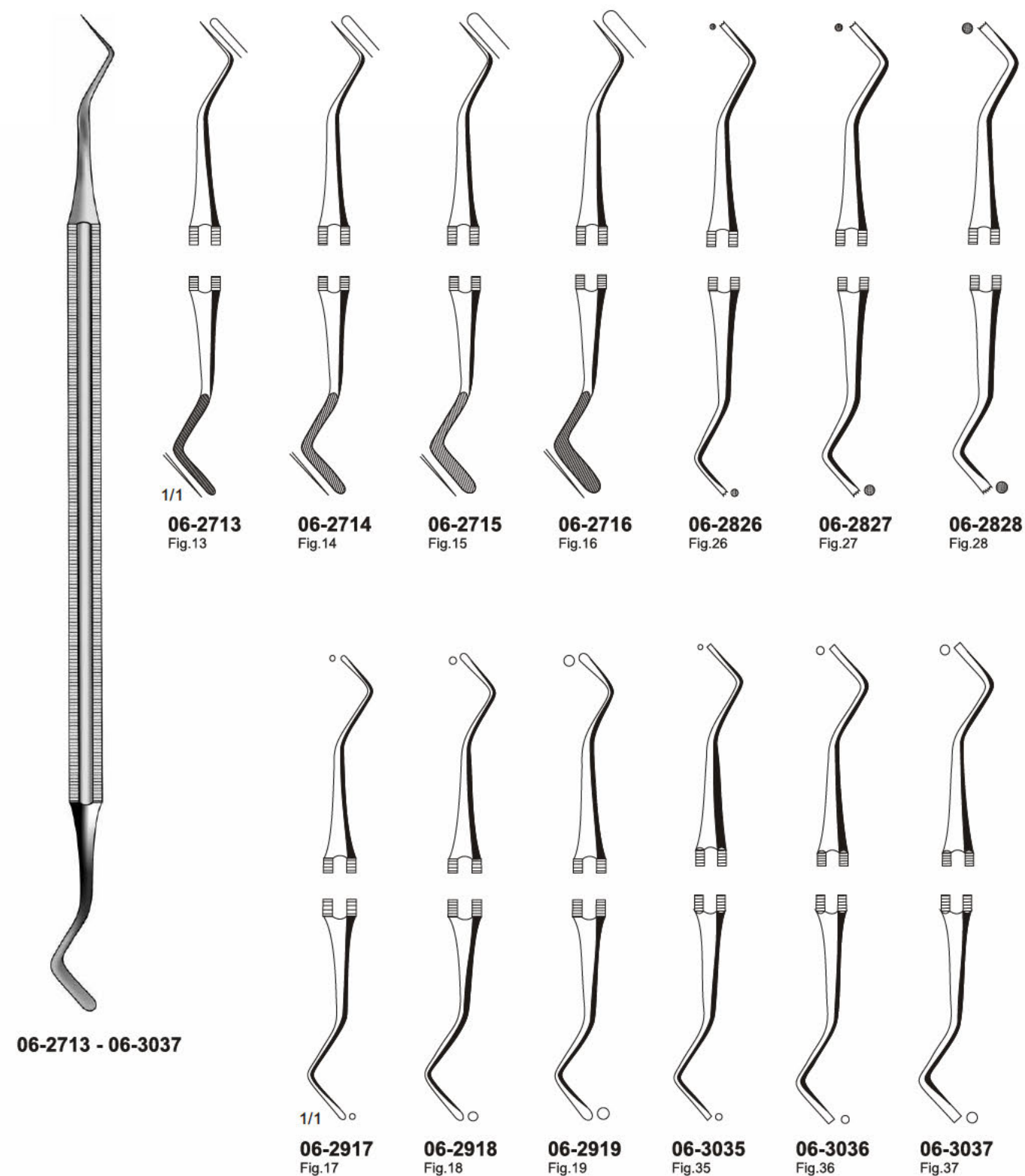

**Burnishers**  
 Polierinstrumente  
 Bruñidores  
 Brunissoirs et Couteaux à amalgame  
 Strumenti per finitura

CH 06

www.surgical-i.com

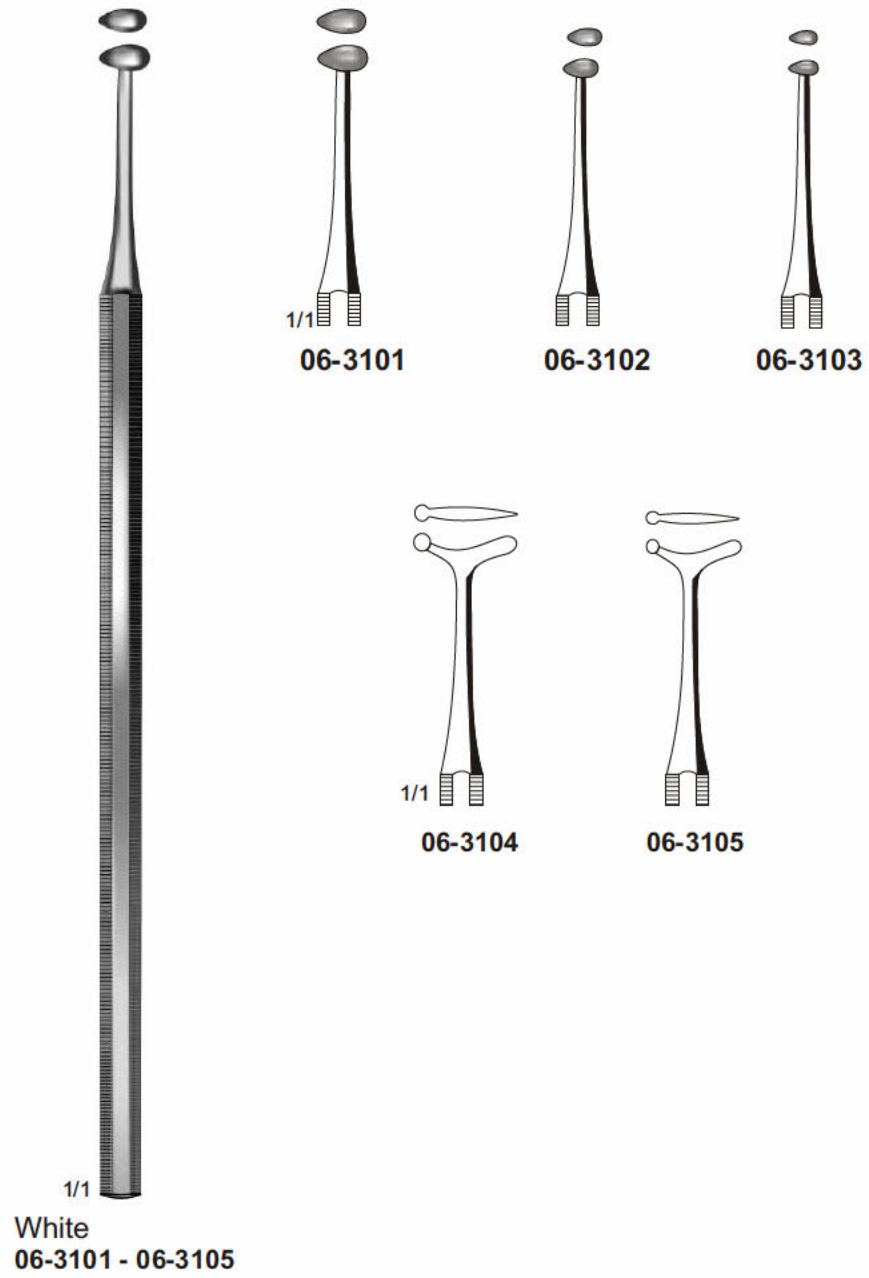

**Cement Spatulas**  
 Zementspatel  
 Espatulas para cemento  
 Spatules à ciment  
 Spatole per cemento

www.surgical-i.com

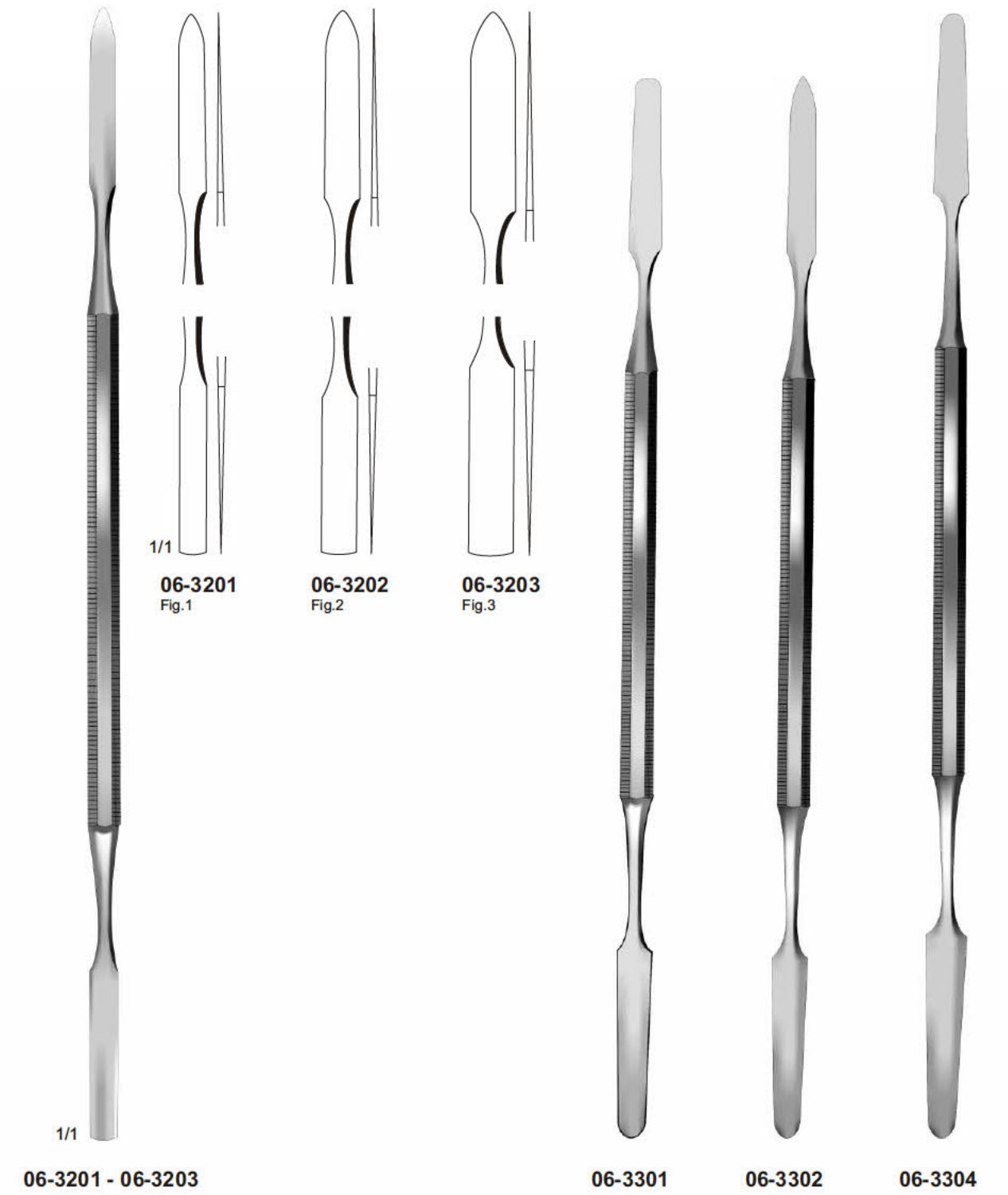

**Cement Spatulas**  
Zementspatel  
Espatulas para cemento  
Spatules à ciment  
Spatole per cemento

CH 06

[www.surgical-i.com](http://www.surgical-i.com)







Please see page 34 for different handle styles.

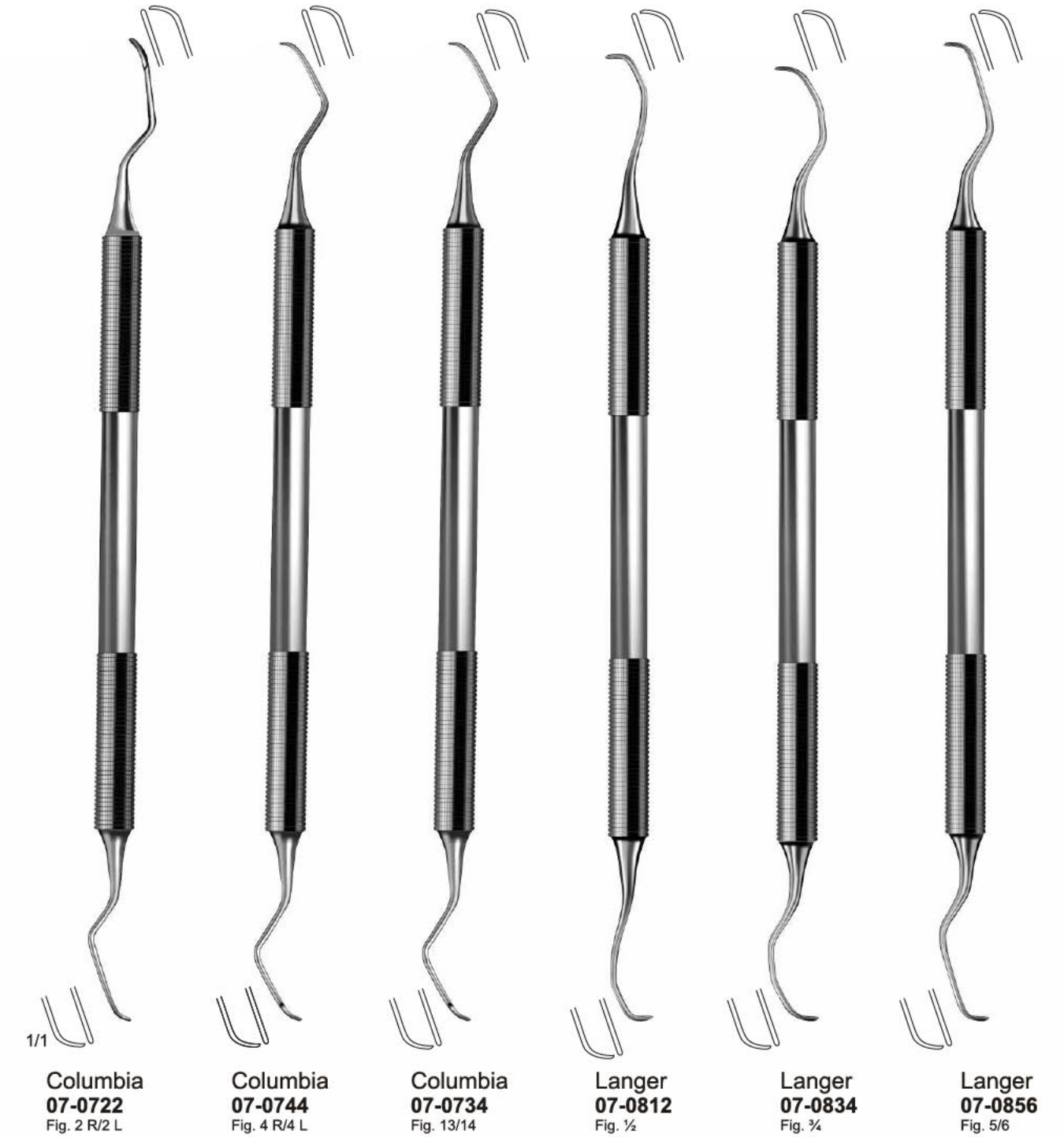

# CH 08

**Periodontia Instruments**  
**Instrumente Zur paradontologie**  
**Instrumentos para periodoncia**  
**Instruments pour la parodontologie**  
**Strumenti per parodontologia**



**Younger-Good**  
**07-0978**  
 Fig. 7/8



**Bates**  
**07-1334**  
 Fig. 135/145



**Barnhart**  
**07-1012**  
 Fig. 1/2



**Rule**  
**07-1434**  
 Fig. 3/4



**Barnhart**  
**07-1056**  
 Fig. 5/6



**07-1441**  
 Fig. 411/412



**Indiana University (Anterior)**  
**07-1134**  
 Fig. 13/14+

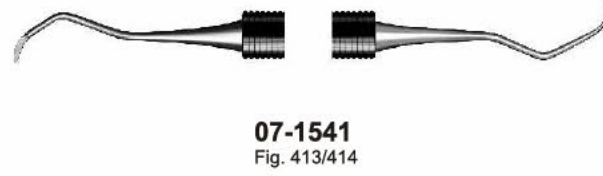

**07-1541**  
 Fig. 413/414



**Indiana University (Posterior)**  
**07-1178**  
 Fig. 17/18+



**Mallery**  
**07-1612**  
 Fig. 1/2



**Bunting**  
**07-1212**  
 Fig. 1/2+



**Goldman**  
**07-1632**  
 Fig. 31/32



**Bunting**  
**07-1256**  
 Fig. 5/6

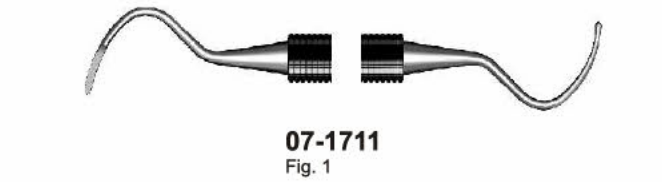

**07-1711**  
 Fig. 1



**Anterior**  
**07-1812**  
 Fig. 1/2

Please see page 34 for different handle styles.



Periodontia Probes

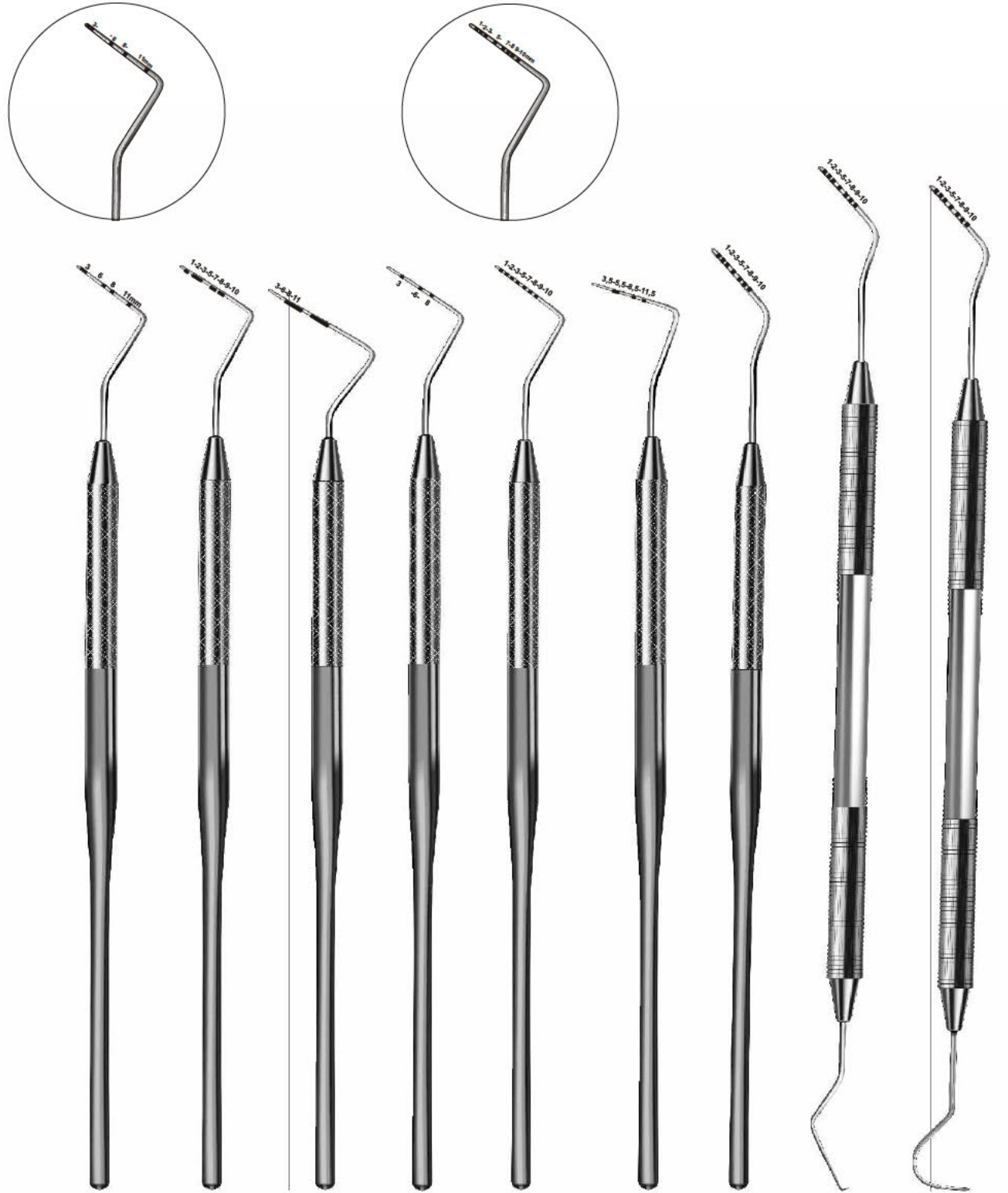

08-0100 Fig. 8  
 08-0101 Fig. W  
 08-0108 Fig. 11  
 08-0110 Fig. 0  
 08-0111 Fig. 10  
 08-0112 Fig. WHO  
 08-0201  
 08-0301  
 08-0302

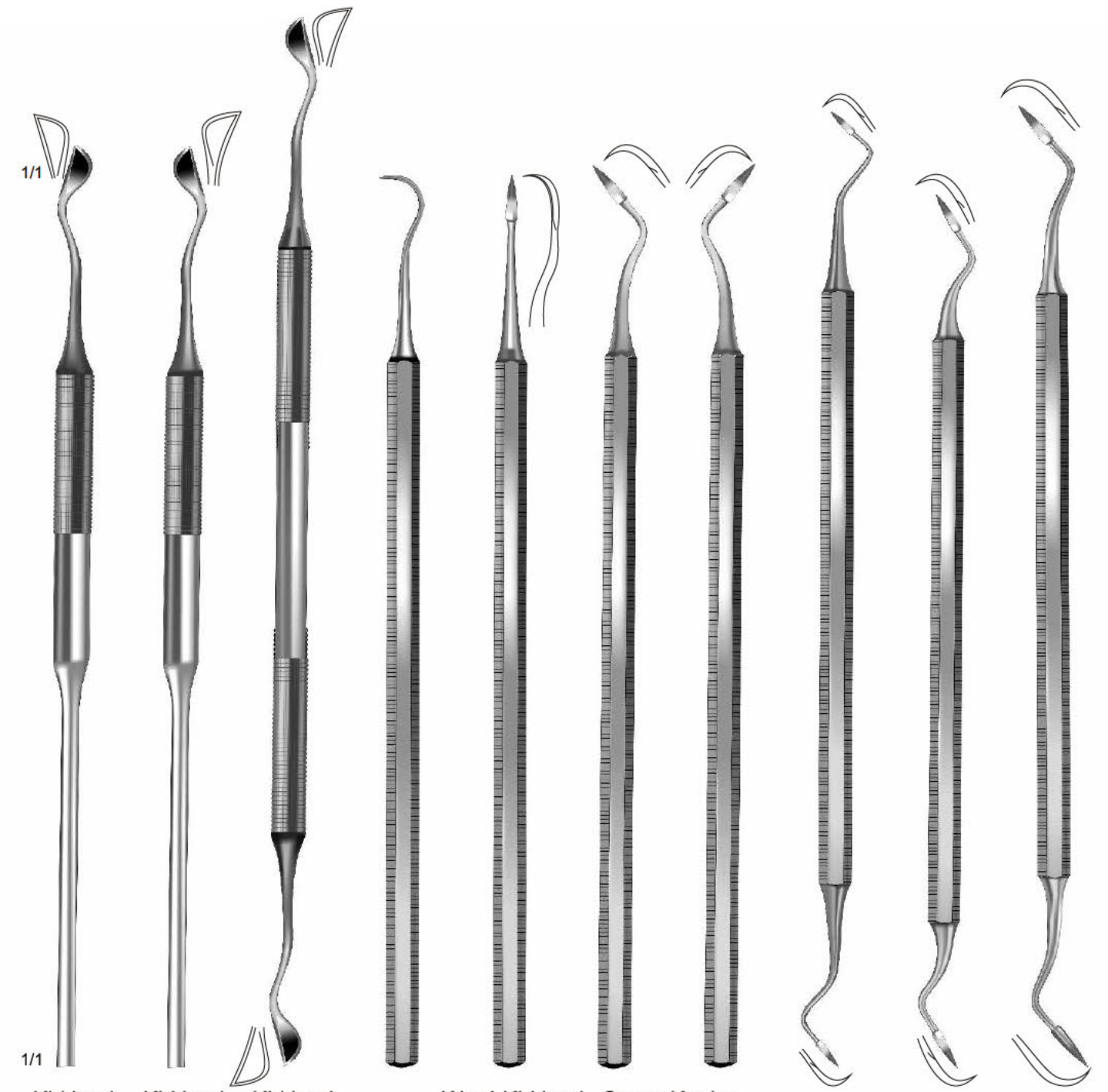

1/1  
 1/1  
 Kirkland 08-0415  
 Kirkland 08-0416  
 Kirkland 08-0501  
 Ward-Kirkland Fig. ST 15  
 08-0604  
 08-0701  
 Crane-Kaplan 08-0802 08-0803  
 08-0901 Fig. ST2/3  
 08-0902 Fig. SCI 2/3  
 08-0903 Fig. SCK 6

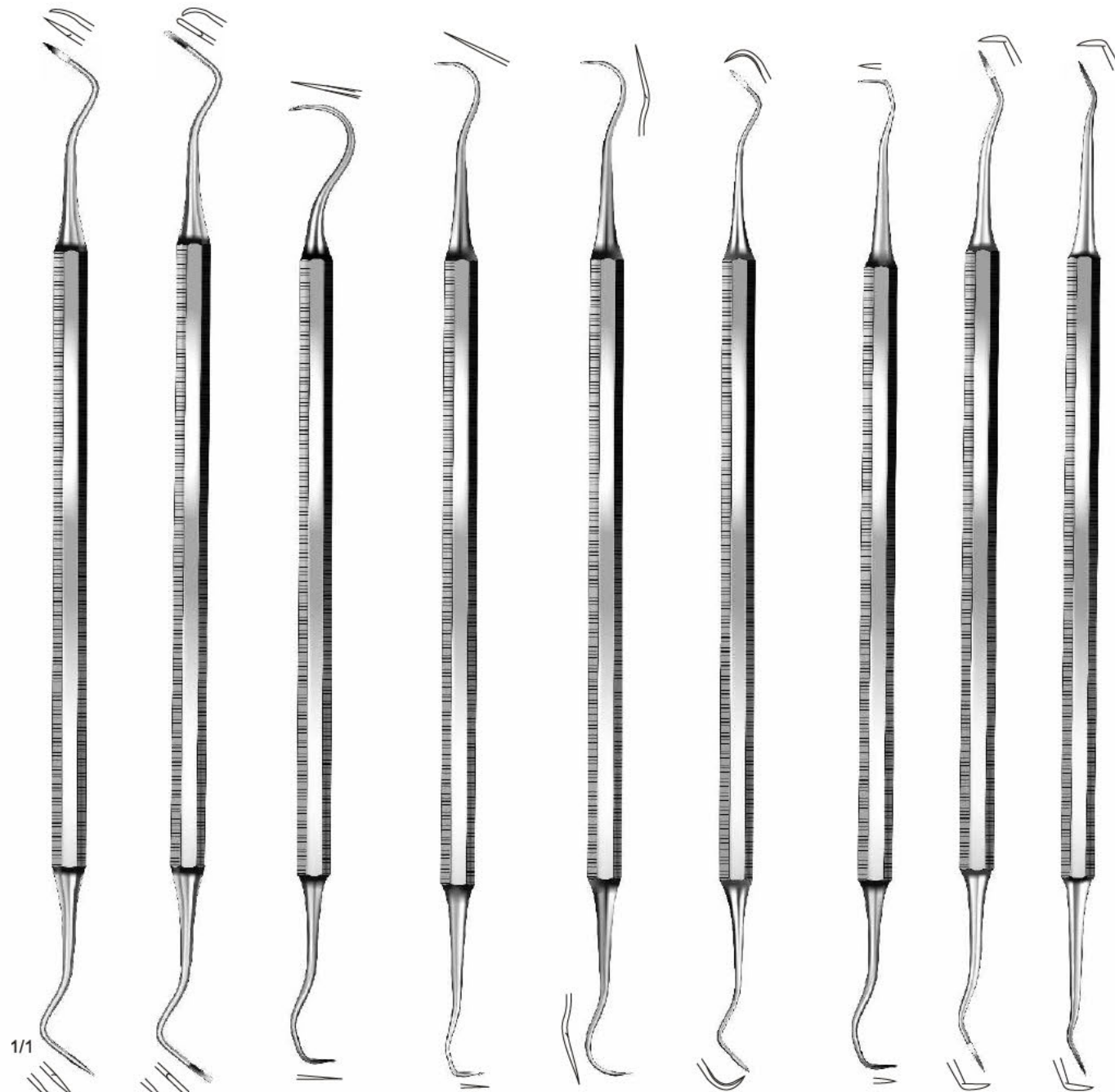

1/1  
 McCall 08-1034 Fig. 13 S/14 S  
 McCall 08-1134 Fig. 13/14  
 Towner-Jaquette 08-1230 Fig. 15/30  
 08-1233 Fig. 5/33  
 Hygenist 08-1267 Fig. 6/7  
 08-1304 Fig. 204 S  
 08-1401 Fig. 30/33  
 Jaquette 08-1402 Fig. 31/32  
 08-1403 Fig. 34/35

Please see page 34 for different handle styles.



08-1507 08-1508 Goldman-Fox 08-1509 08-1510 08-1511 08-1521 Nabers 08-1600 Cross 08-1601 Prichard 08-1700

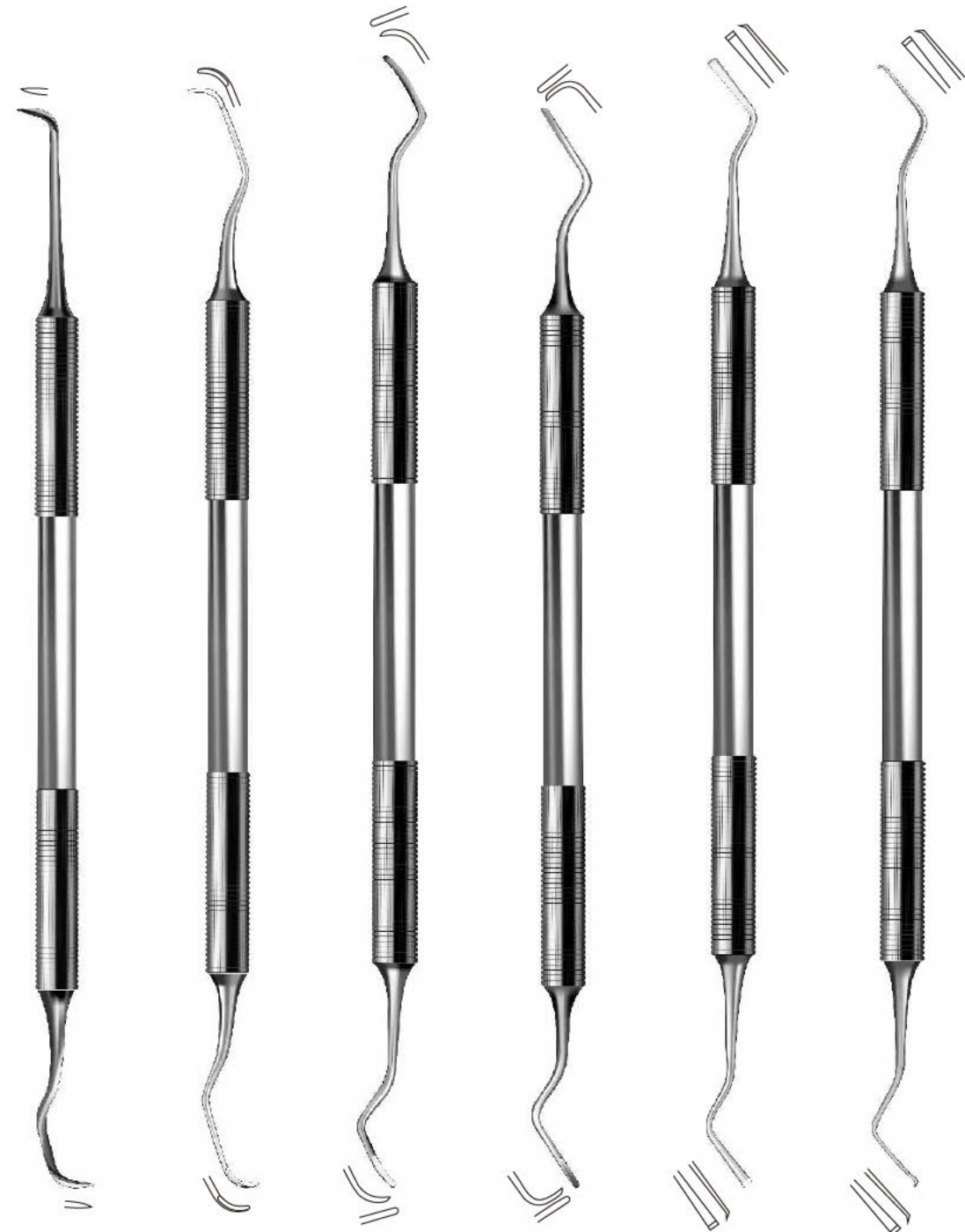

Goldman Fox  
**08-2101** 16cm/ 6 1/4"  
**08-2102** 16cm/ 6 1/4"  
**08-2103** 16cm/ 6 1/4"  
**08-2104** 16cm/ 6 1/4"  
**08-2105** 16cm/ 6 1/4"  
**08-2106** 16cm/ 6 1/4"

Please see page 34 for different handle styles.



Ochsenbein **08-2201** Fig. 1  
 Ochsenbein **08-2202** Fig. 2  
 Ochsenbein **08-2303** Fig. 3  
 Ochsenbein **08-2304** Fig. 4  
 Fedi **08-2501** Fig. 1  
 Fedi **08-2502** Fig. 2  
 Fedi **08-2503** Fig. 3

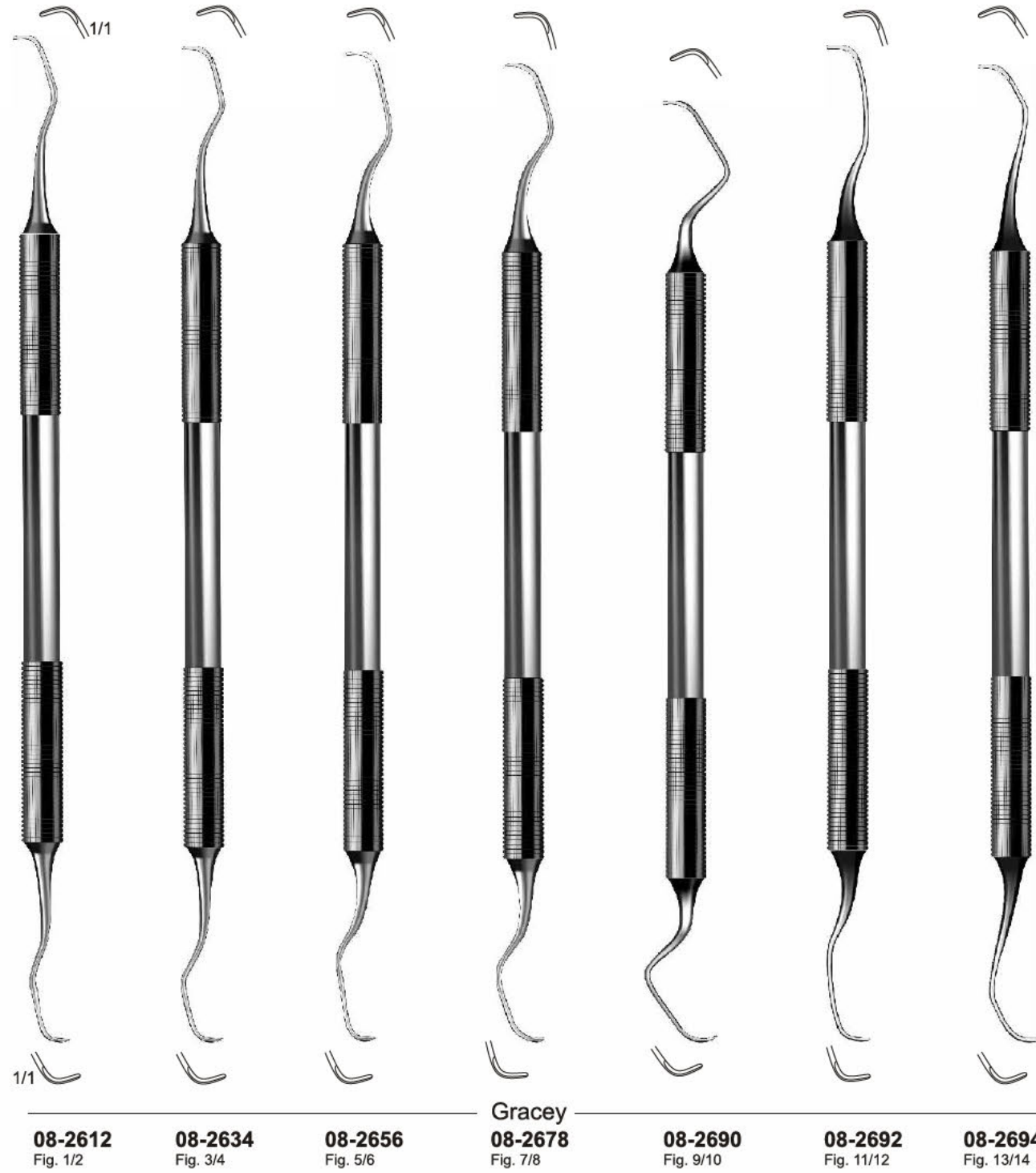

# CH 09

**Excavators, Probes & Explorers, Nerve instruments**  
 Exkavatoren, Zahnsonden,  
 Nervinstrumente  
 Excavadores, sondas y  
 exploradores, Instrumentos  
 para nervios  
 Excavateurs, Sondes, et  
 exploreurs  
 Escavatori, Sonde, Strumenti  
 per nervi



Please see page 34 for different handle styles.



Please see page 34 for different handle styles.

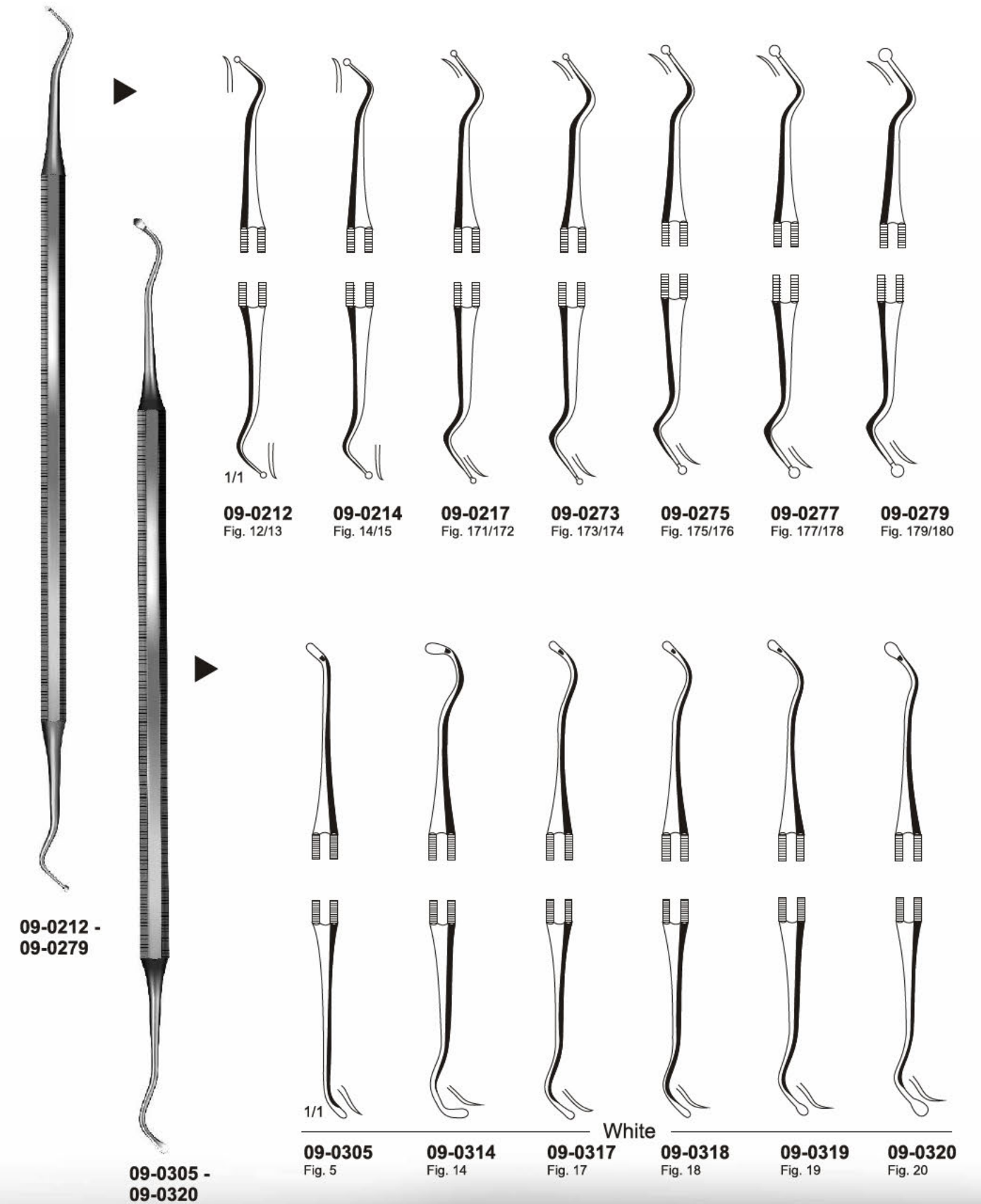

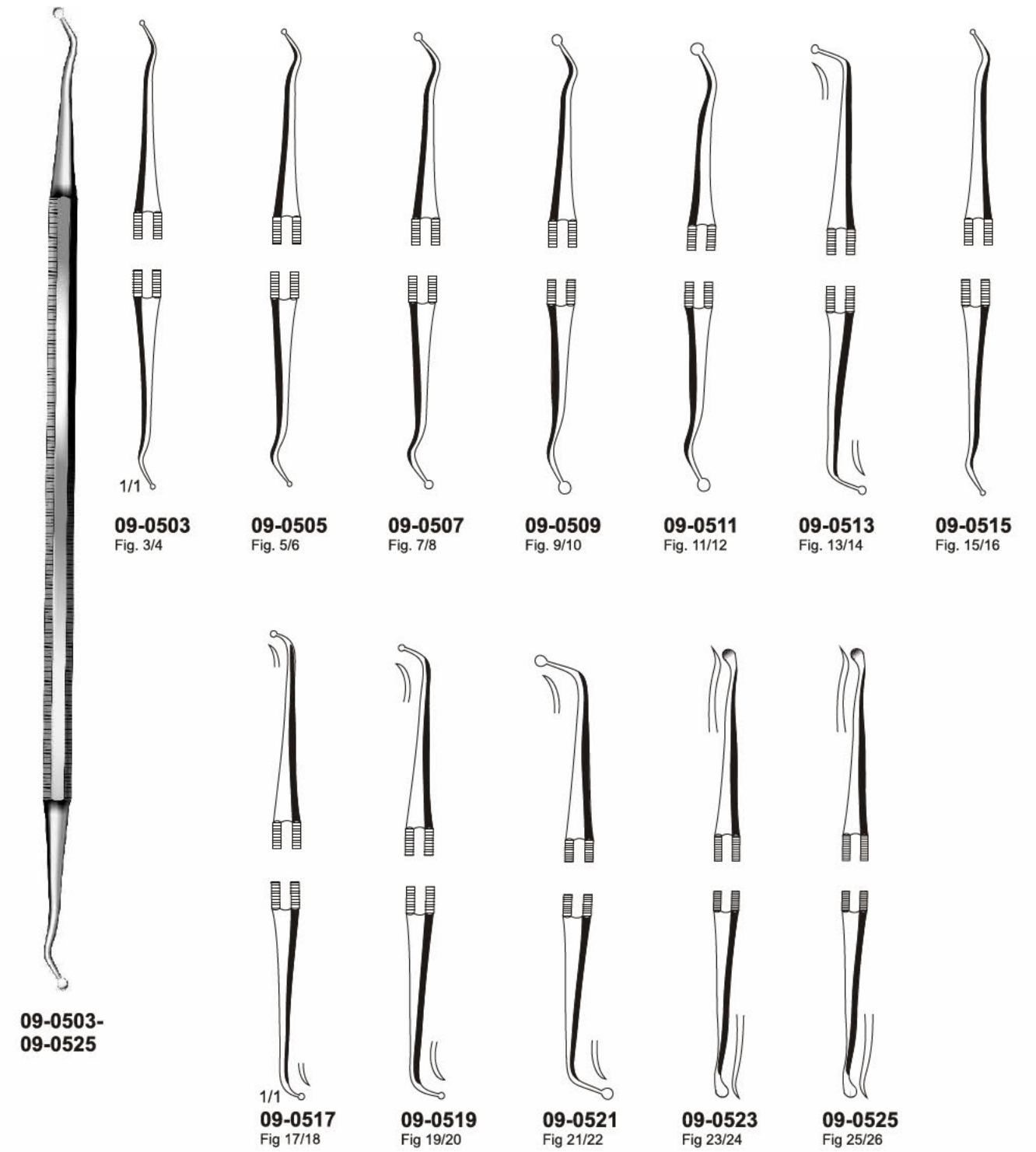
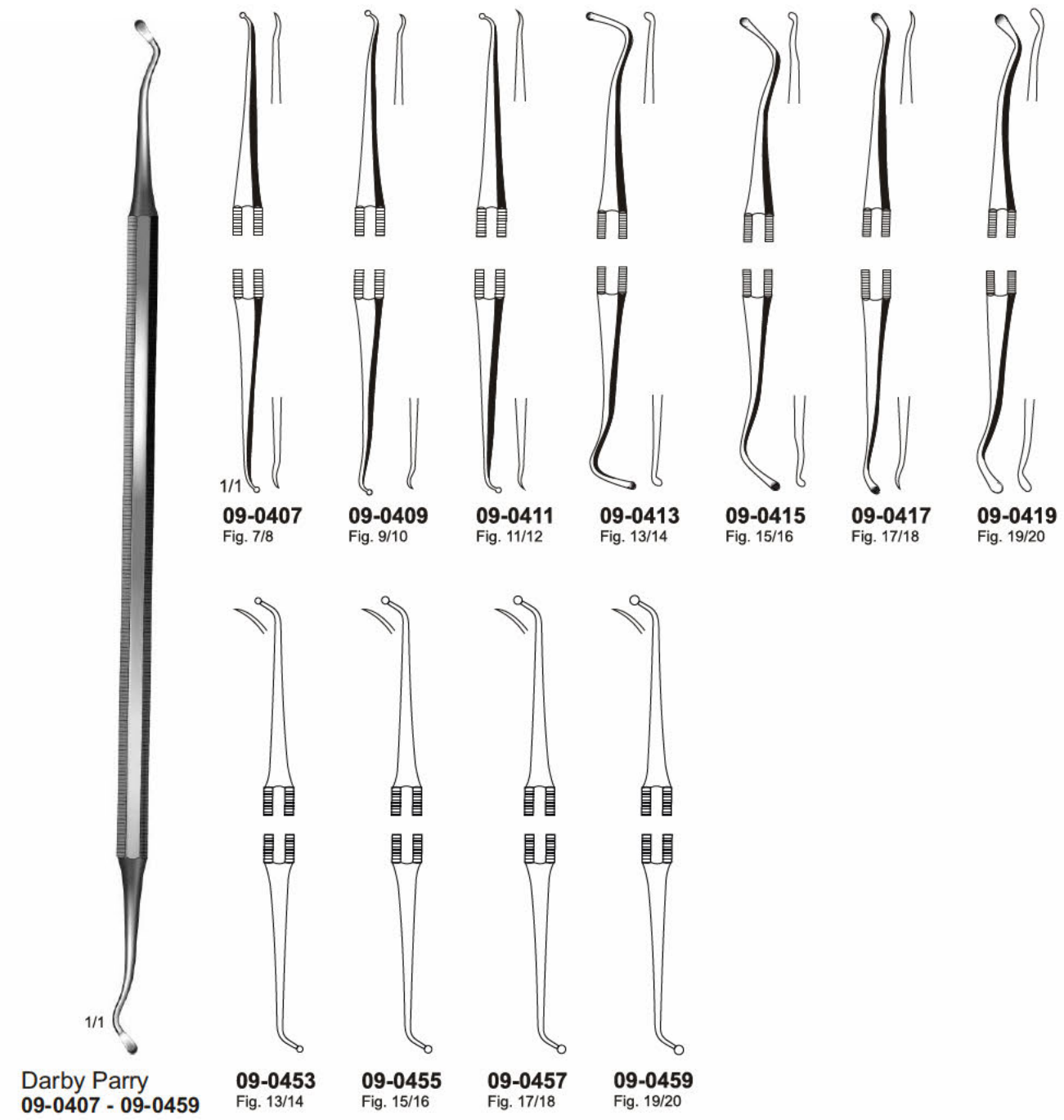



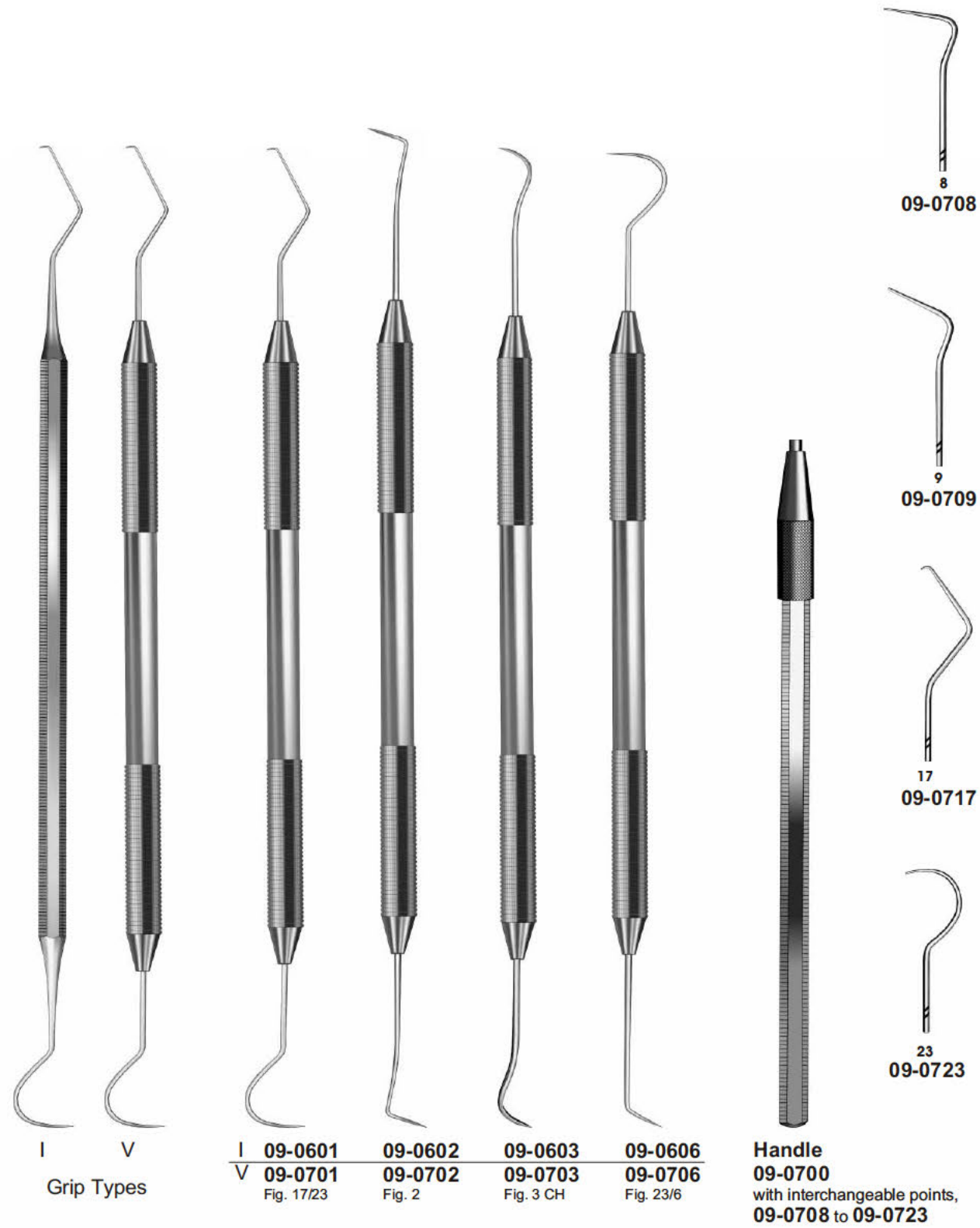

Please see page 34 for different handle styles.

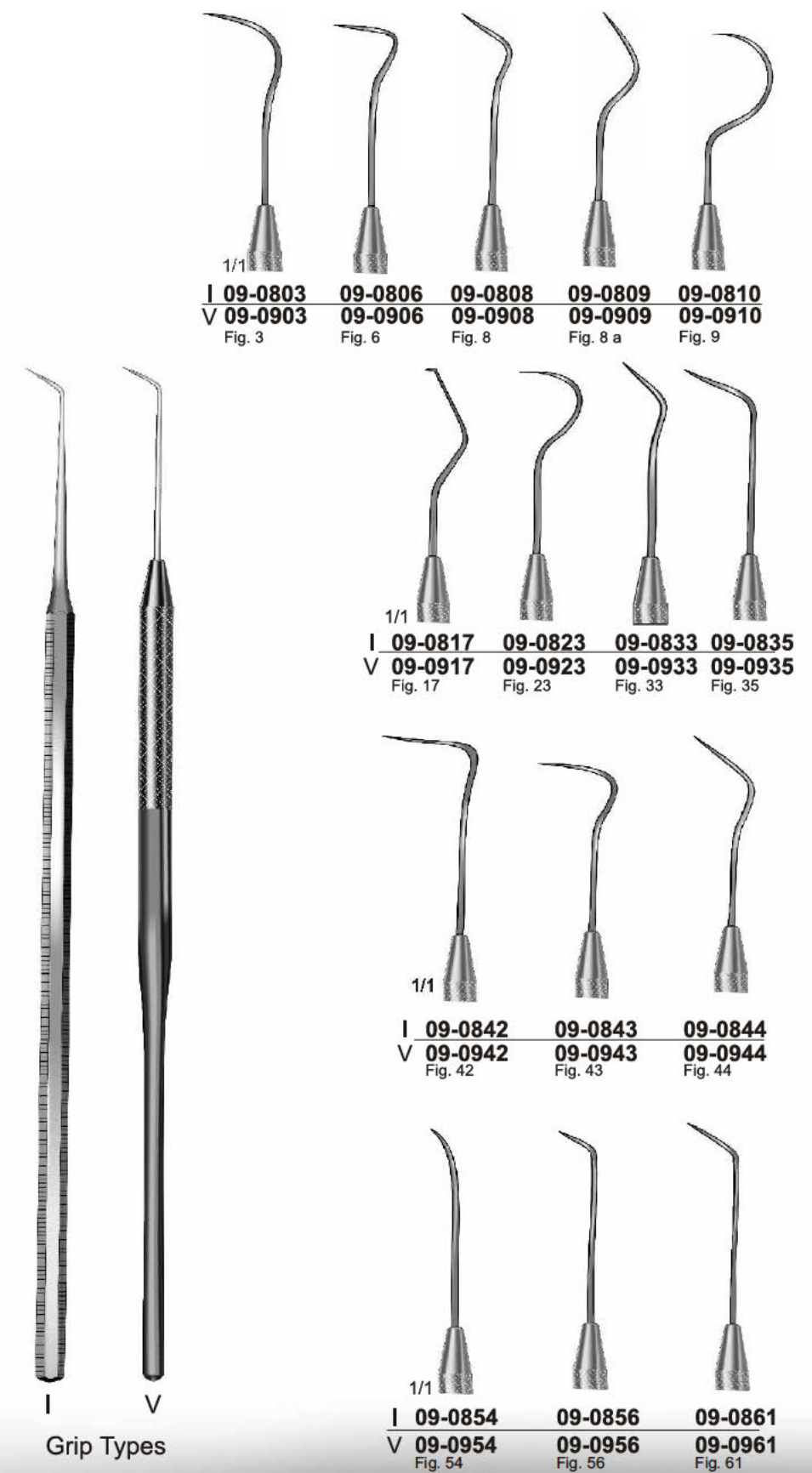

**Nerve-canal and root-canal condensers**  
 Nervkanal-und wurzelkanal-stopfer  
 Tapón para el canal del nervio y el canal de la raíz  
 Obturateur de canal nerveux et de canal radiculaire  
 Condensatori per nervi e canali radicolari

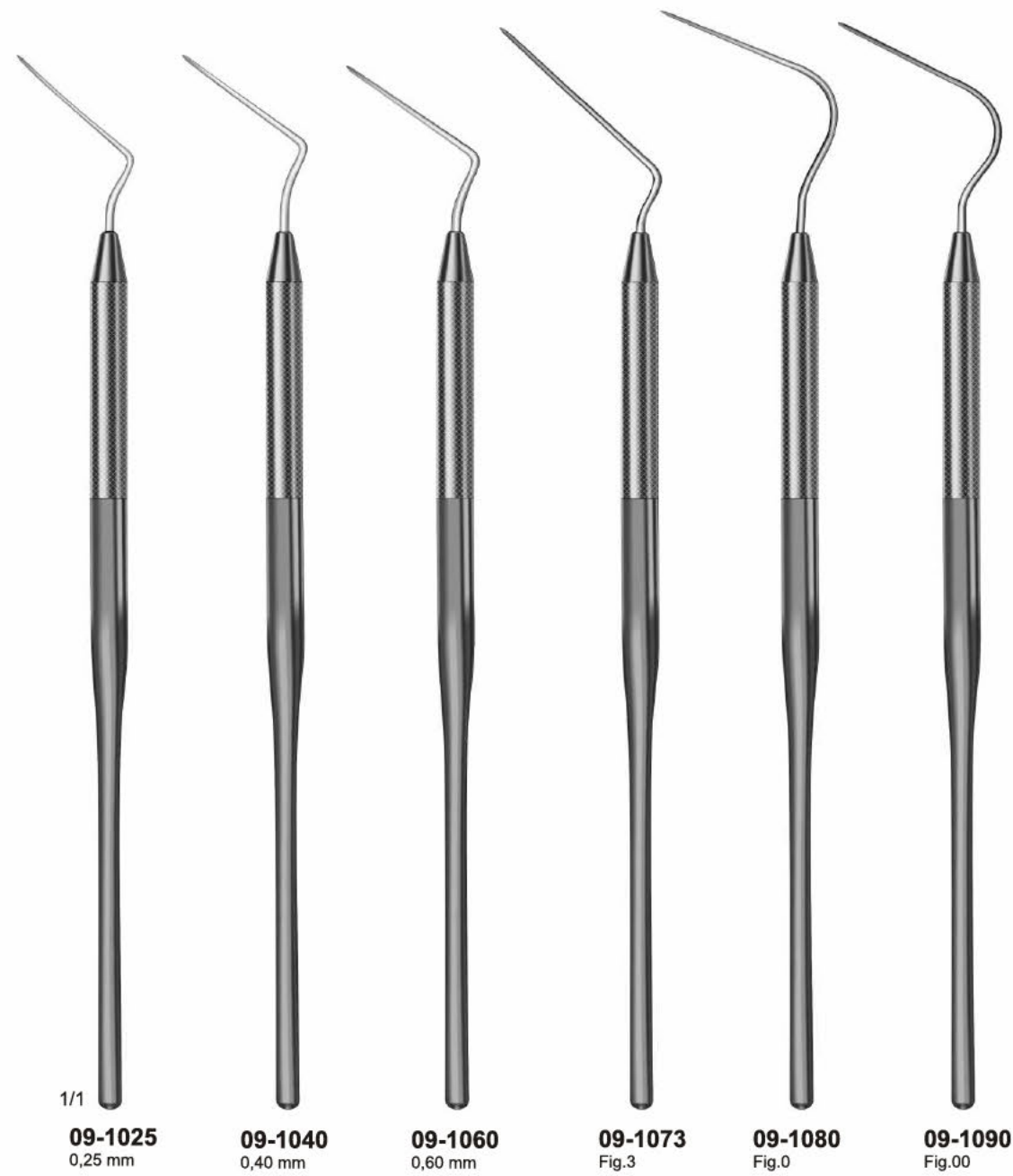

**Nerve-canal and root-canal condensers**  
 Nervkanal-und wurzelkanal-stopfer  
 Tapón para el canal del nervio y el canal de la raíz  
 Obturateur de canal nerveux et de canal radiculaire  
 Condensatori per nervi e canali radicolari

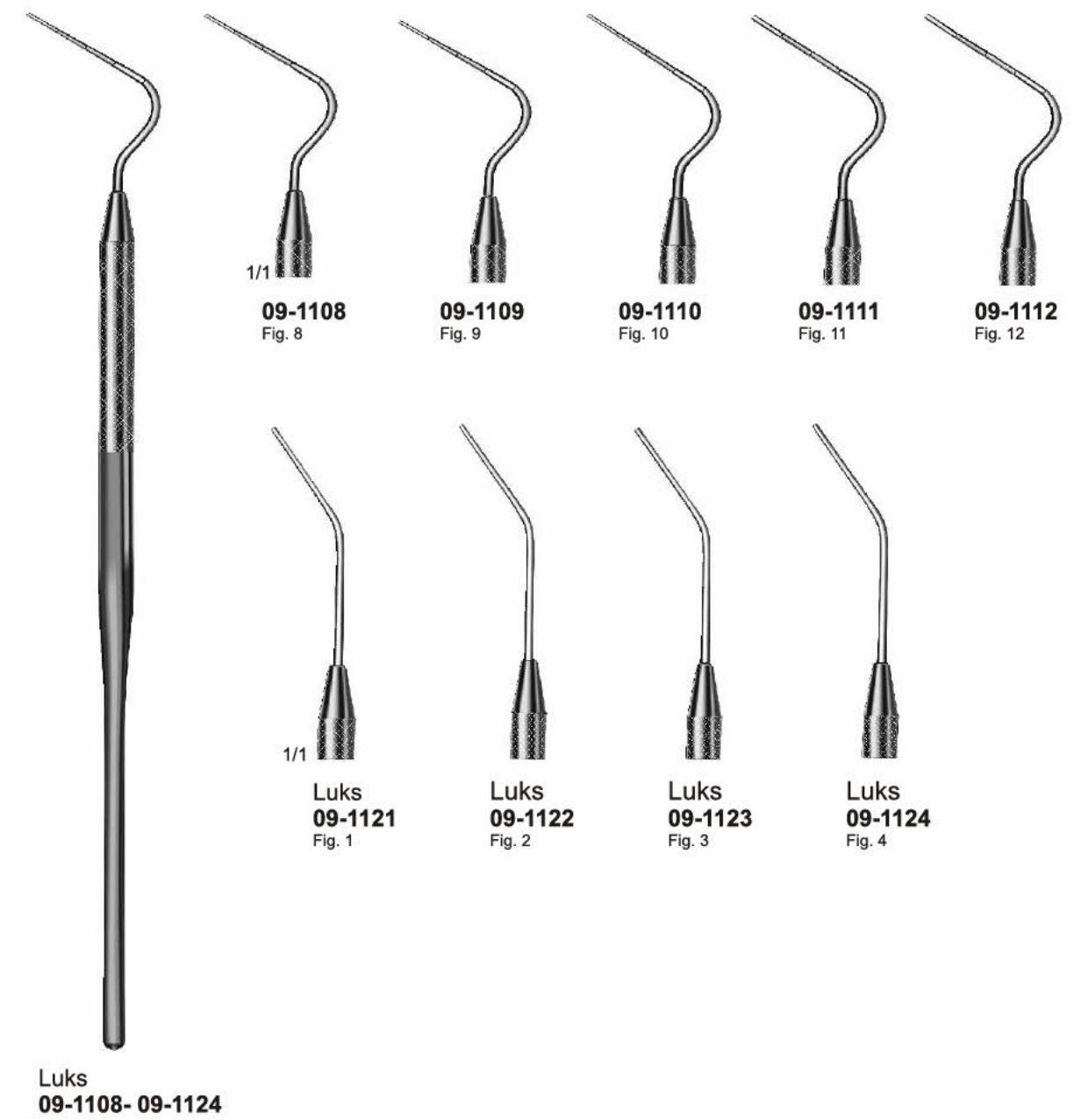

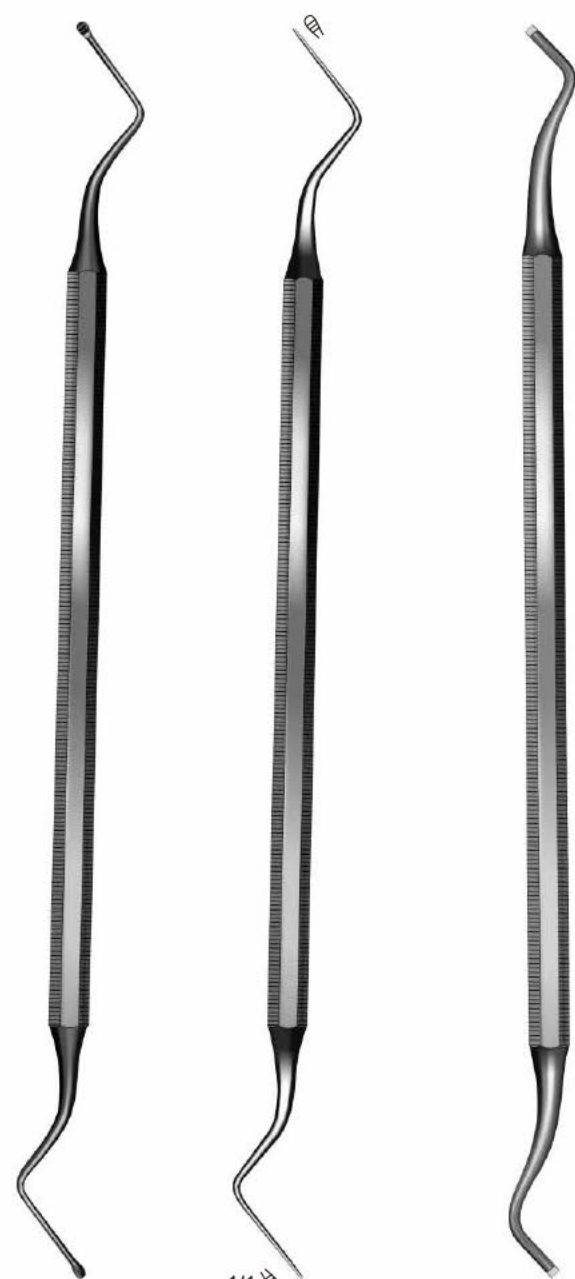

Hirschfeld  
 09-1237  
 Fig. 3/7

1/1  
 Hirschfeld  
 09-1211  
 Fig. 5/11

Black  
 09-1351 - 09-1379

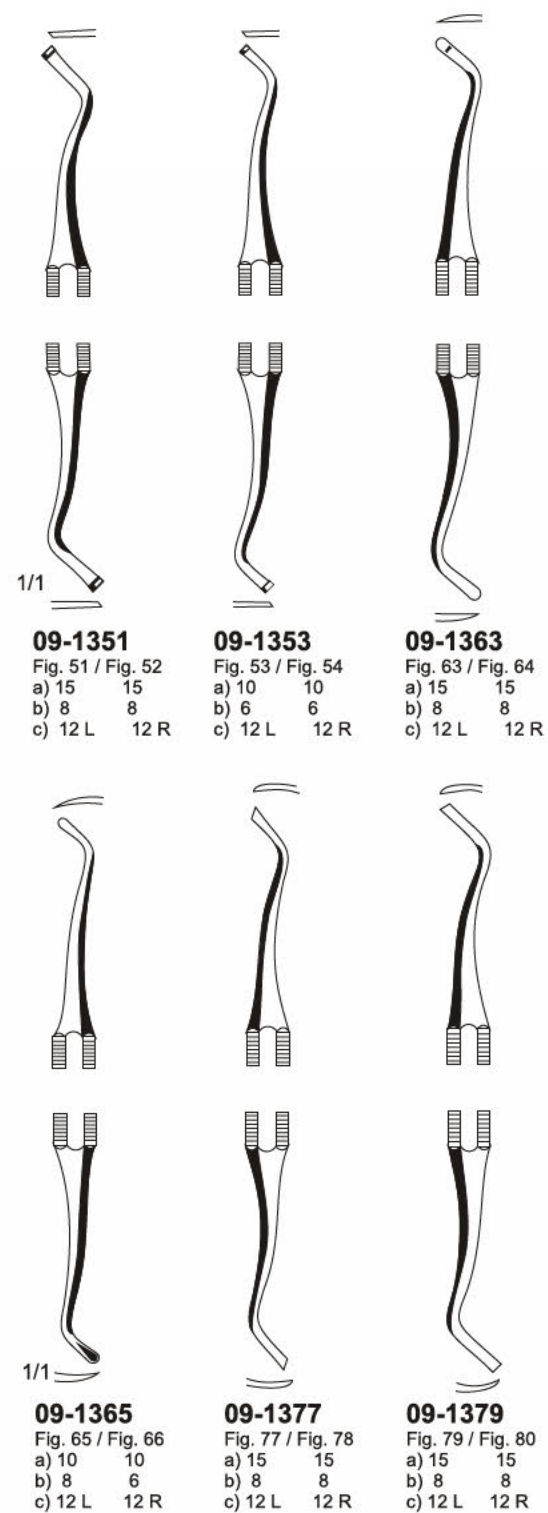

09-1351  
 Fig. 51 / Fig. 52  
 a) 15 15  
 b) 8 8  
 c) 12 L 12 R

09-1353  
 Fig. 53 / Fig. 54  
 a) 10 10  
 b) 6 6  
 c) 12 L 12 R

09-1363  
 Fig. 63 / Fig. 64  
 a) 15 15  
 b) 8 8  
 c) 12 L 12 R

09-1365  
 Fig. 65 / Fig. 66  
 a) 10 10  
 b) 8 6  
 c) 12 L 12 R

09-1377  
 Fig. 77 / Fig. 78  
 a) 15 15  
 b) 8 8  
 c) 12 L 12 R

09-1379  
 Fig. 79 / Fig. 80  
 a) 15 15  
 b) 8 8  
 c) 12 L 12 R

a) Width of blade in 1/10 mm  
 b) Length of blade from the centre of angle in mm  
 c) Angle of blade to its handle in centigrade

# CH 10

Wax and Crown Instruments,  
 Matrix Instruments  
 Wachs- kroneninstrumente,  
 Matrizen-instrumente  
 Instrumentos para cera, coronas,  
 instrumentos para matrices  
 Instruments pour couronnes  
 et matrices  
 Strumenti per cera e per corone,  
 Strumenti per matrici



Wax, Porcelain and Modelling Carvers  
 Wachs-porzellan und modellierinstrumente  
 Talladores y espátulas para cera, porcelana y para modelar  
 Instruments à cire et à modeler  
 Strumenti per cera e modellazione

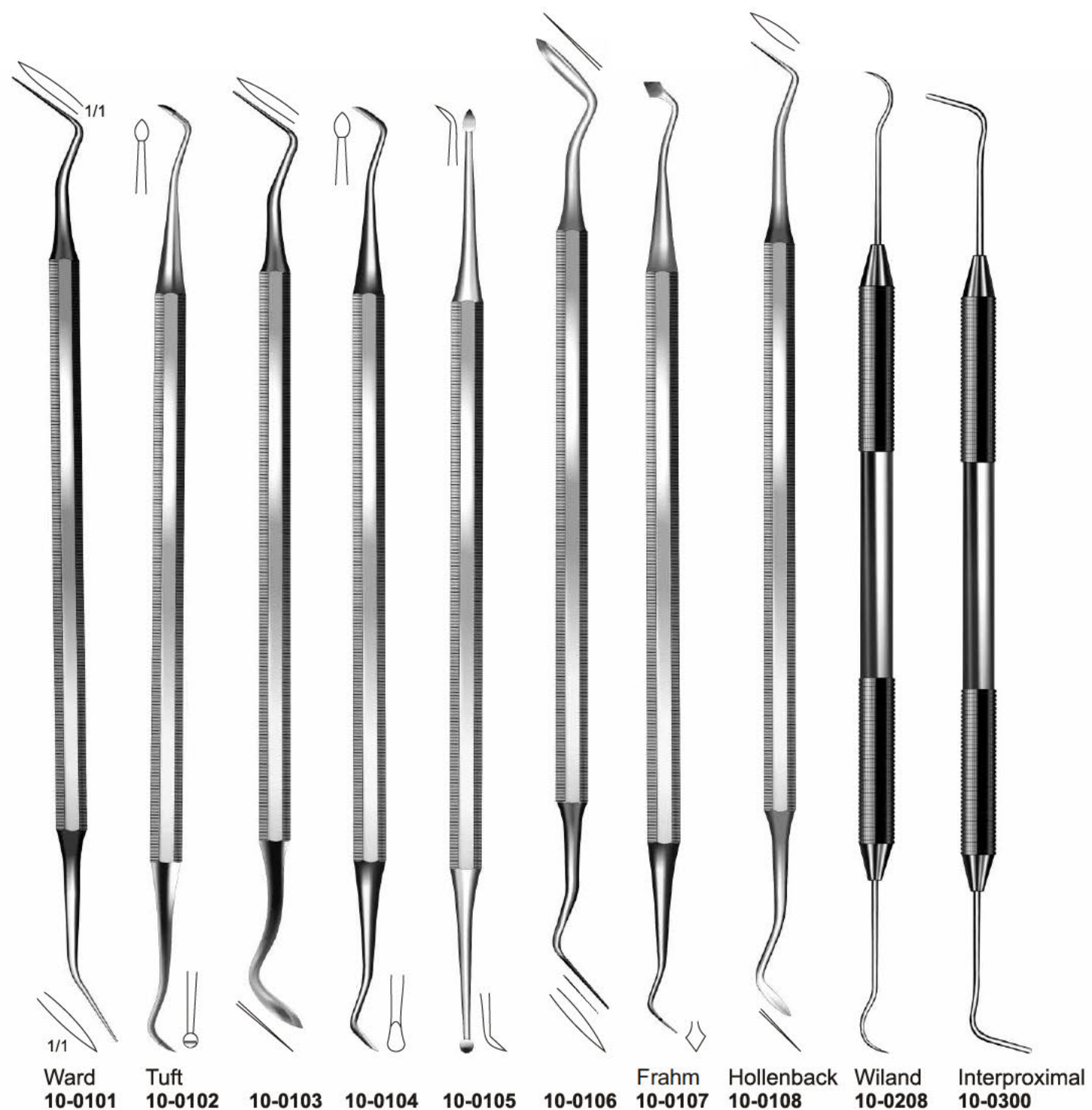

Wax, Porcelain and Modelling Carvers  
 Wachs-porzellan und modellierinstrumente  
 Talladores y espátulas para cera, porcelana y para modelar  
 Instruments à cire et à modeler  
 Strumenti per cera e modellazione



**Wax, Porcelain and Modelling Carvers**  
 Wachs-porzellan und modellierinstrumente  
 Talladores y espátulas para cera, porcelana y para modelar  
 Instruments à cire et à modeler  
 Strumenti per cera e modellazione

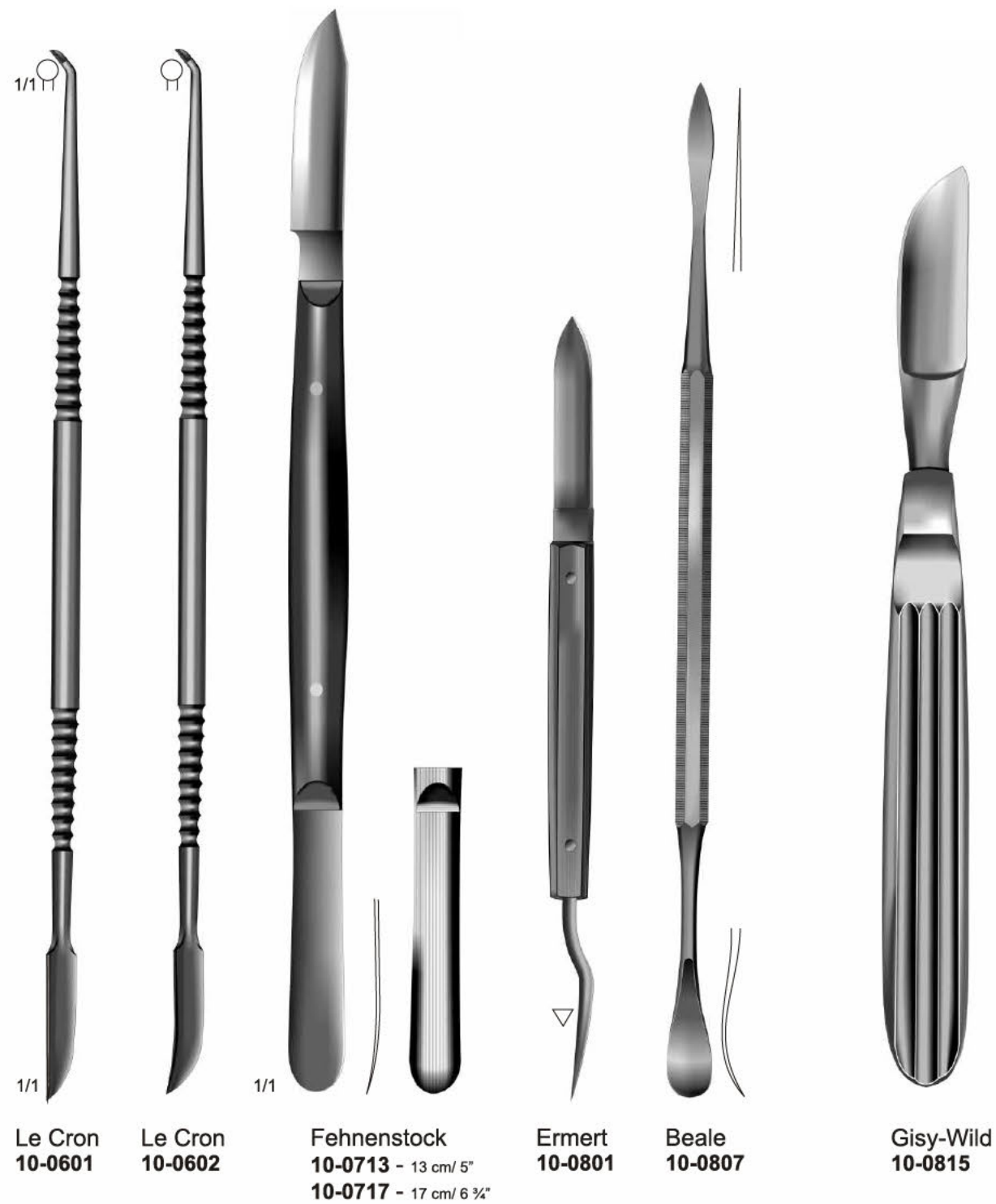

**Crown Instruments**  
 kroneninstrumente  
 Instrumentos para coronas  
 Instruments pour couronnes  
 Strumenti per corone

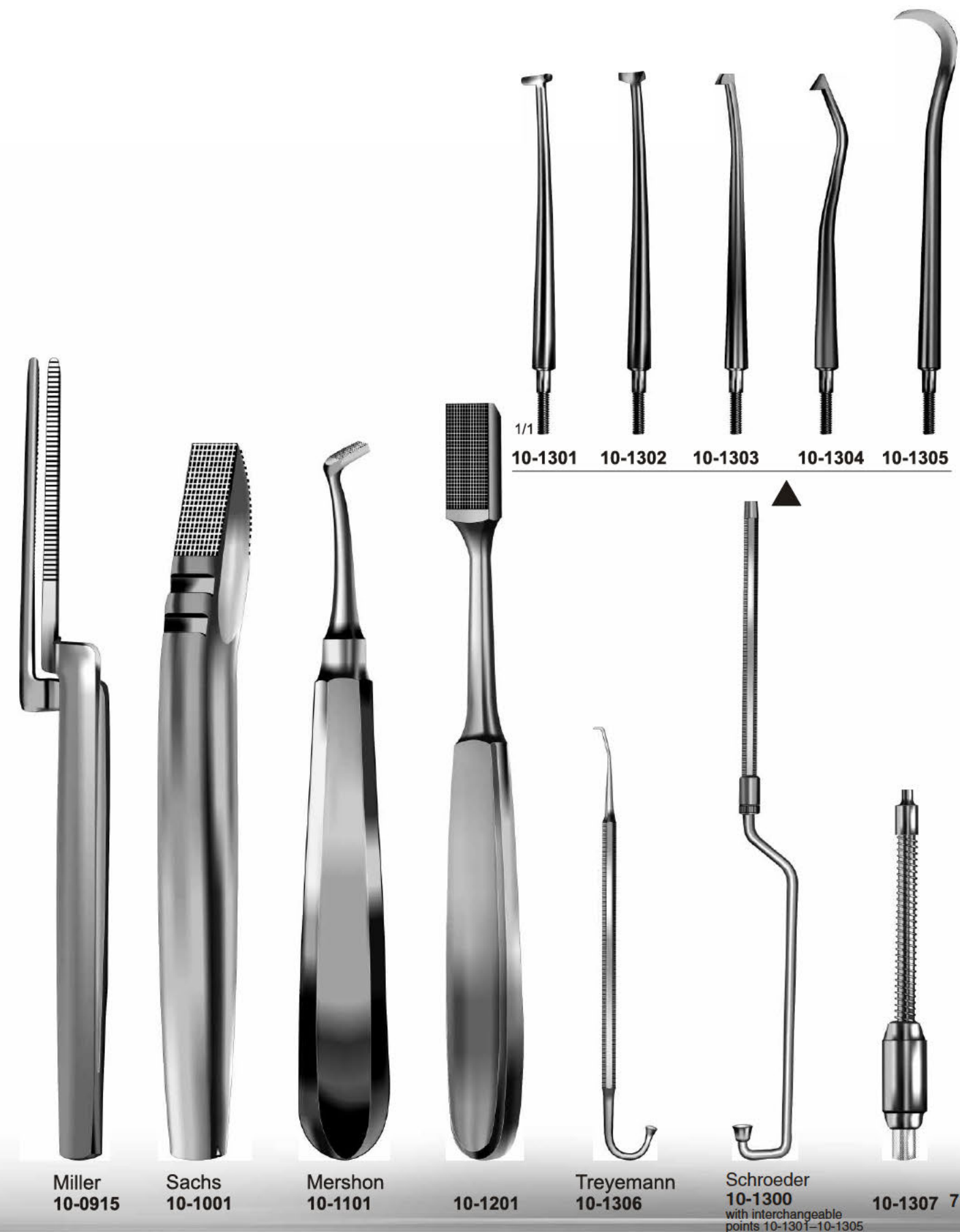

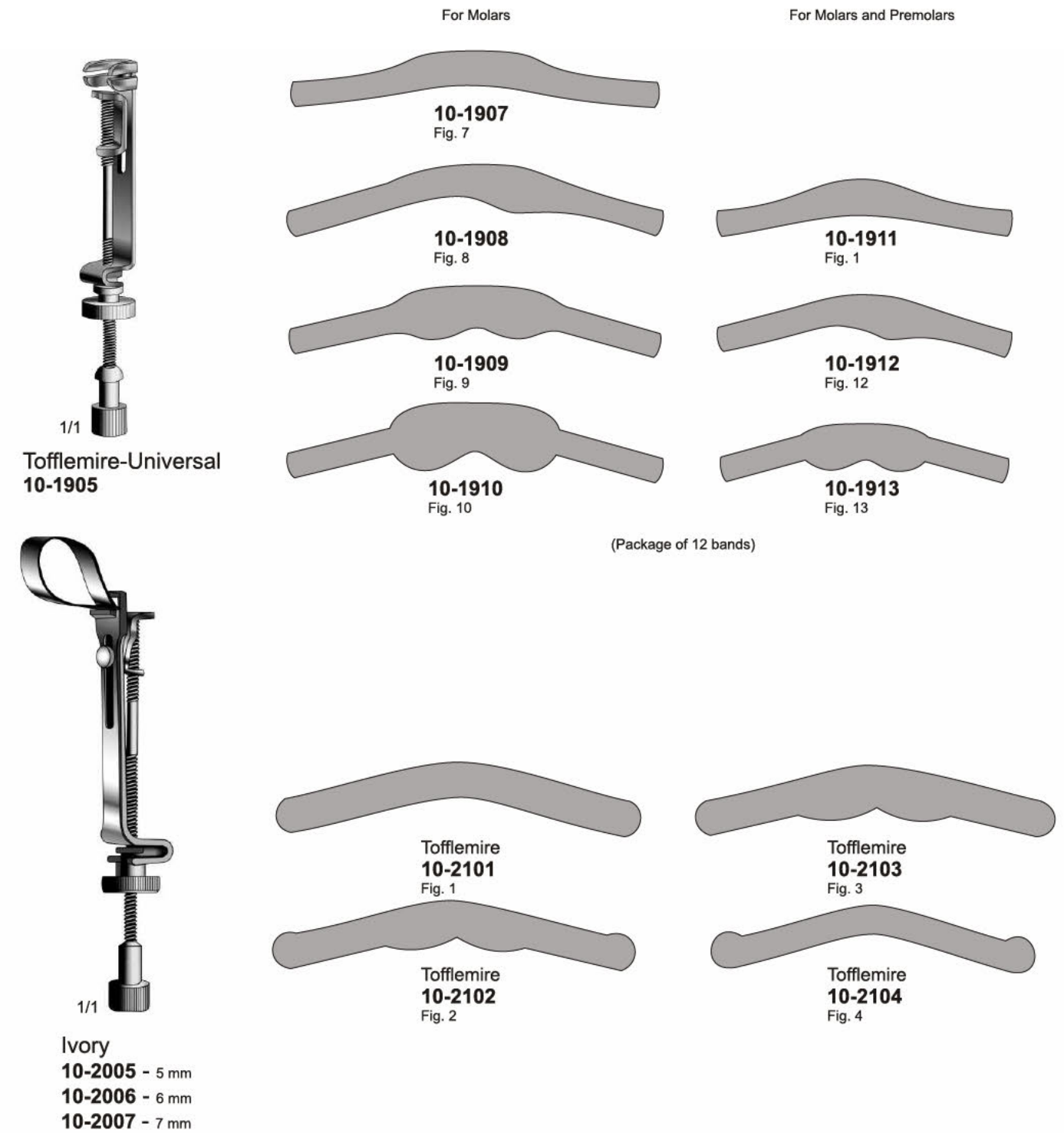
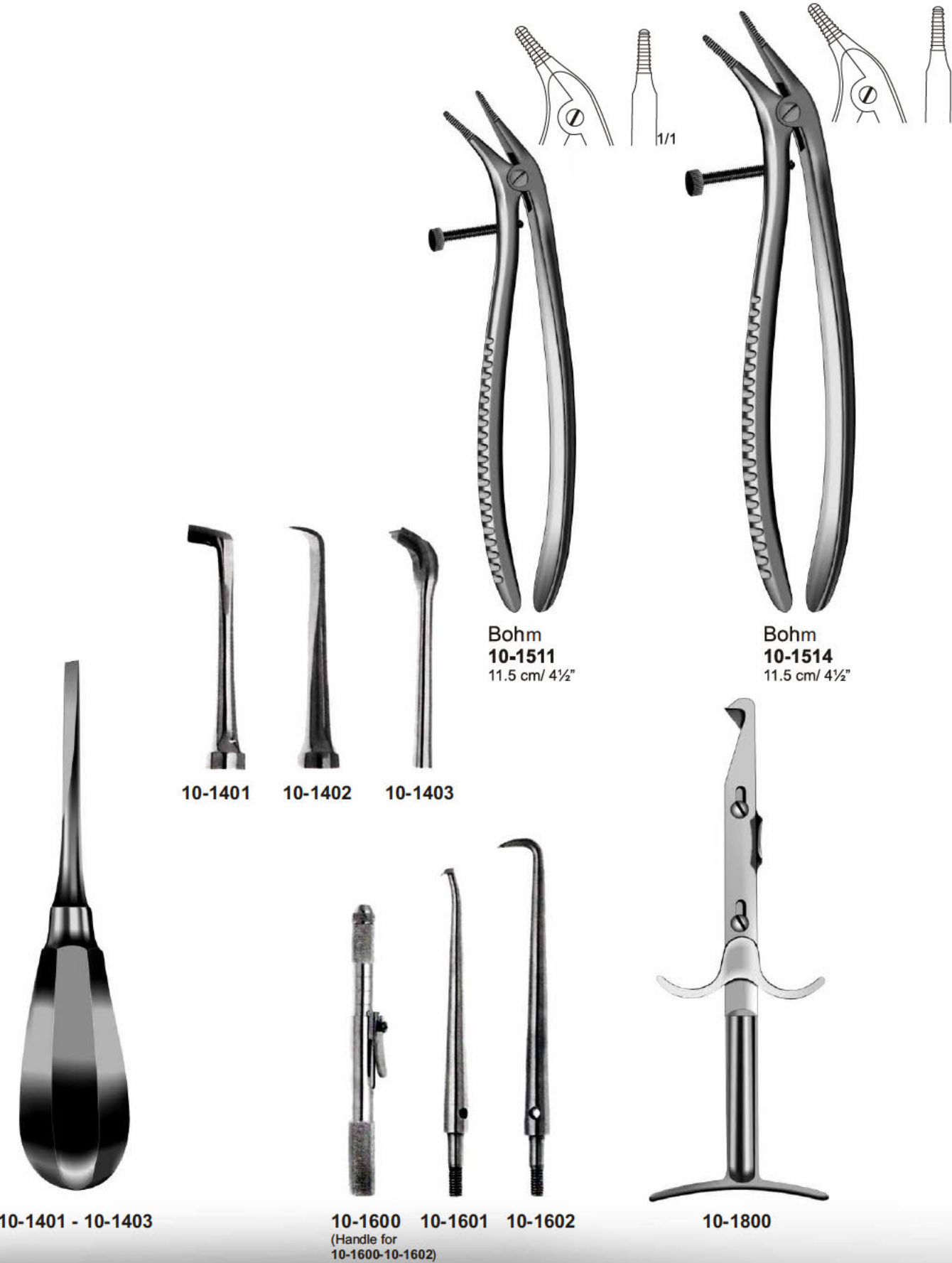

# CH 11

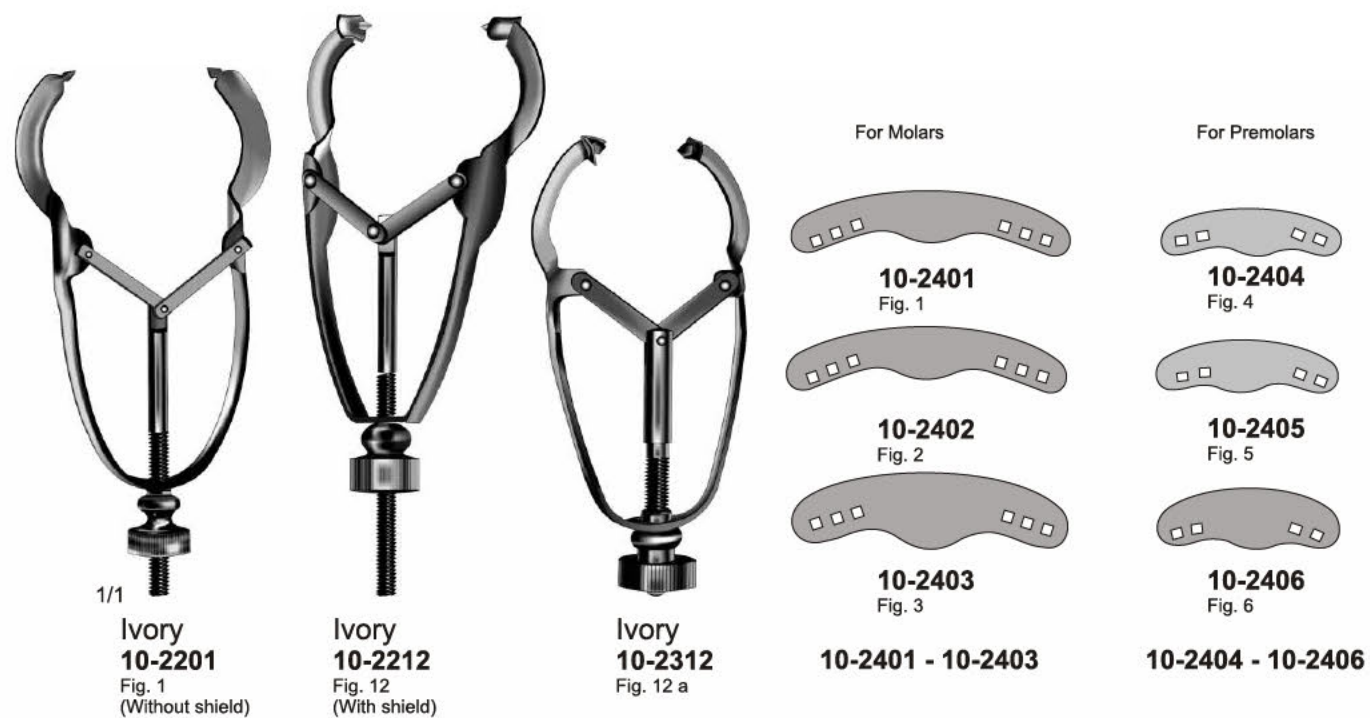

## Impression Trays

Abdrucklöffler  
 Portamoldes  
 Porte-empreintes  
 Porta-impronte



Stainless Steel



Stainless steel "Solid" impression trays with retention rim.

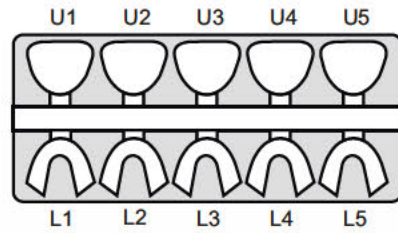

set  
10

Set of 10 pieces.  
11-2003

For Upper Jaw



			mm.	mm.
11-2051- U1	XL		81	63
11-2052- U2	L		74	60
11-2053- U3	M		71	55
11-2054- U4	NM		67	53
11-2055- U5	S		65	51

For Lower Jaw



			mm.	mm.
11-2061- L1	XL		80	63
11-2062- L2	L		78	59
11-2063- L3	M		76	57
11-2064- L4	NM		72	57
11-2065- L5	S		69	50

Stainless steel "Perforated" impression trays with retention rim.

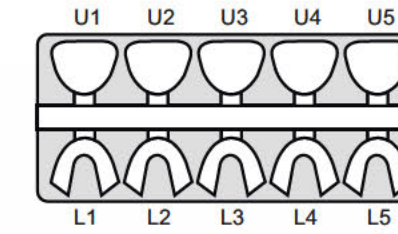
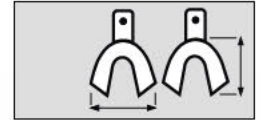
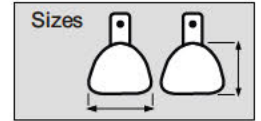

set  
10

Set of 10 pieces.  
11-2103

For Upper Jaw



			mm.	mm.
11-2151- U1	XL		81	63
11-2152- U2	L		74	60
11-2153- U3	M		71	55
11-2154- U4	NM		67	53
11-2155- U5	S		65	51

For Lower Jaw



			mm.	mm.
11-2161- L1	XL		80	63
11-2162- L2	L		78	59
11-2163- L3	M		76	57
11-2164- L4	NM		72	57
11-2165- L5	S		69	50



Stainless Steel

INOX  
18/08

Stainless steel "Solid" impression trays with retention rim.

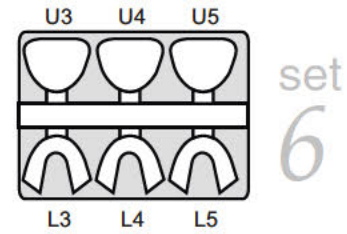

set  
6

Set of 6 pieces.  
11-2301

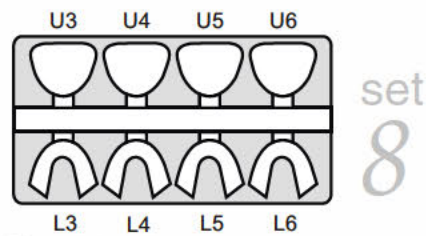

set  
8

Set of 8 pieces.  
11-2302

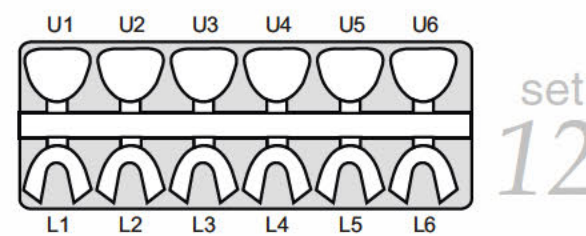

set  
12

Set of 12 pieces.  
11-2304

For Upper Jaw

For Lower Jaw

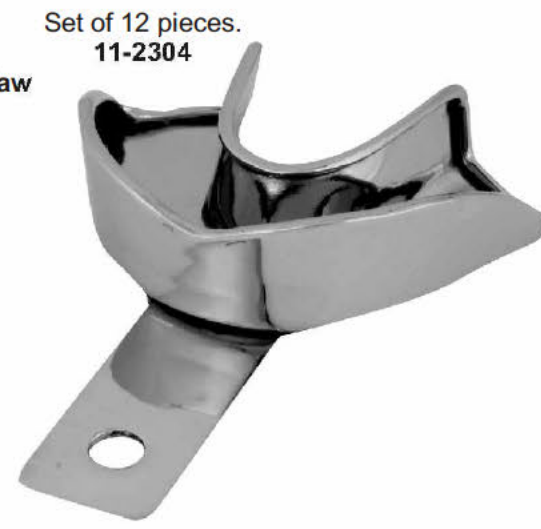
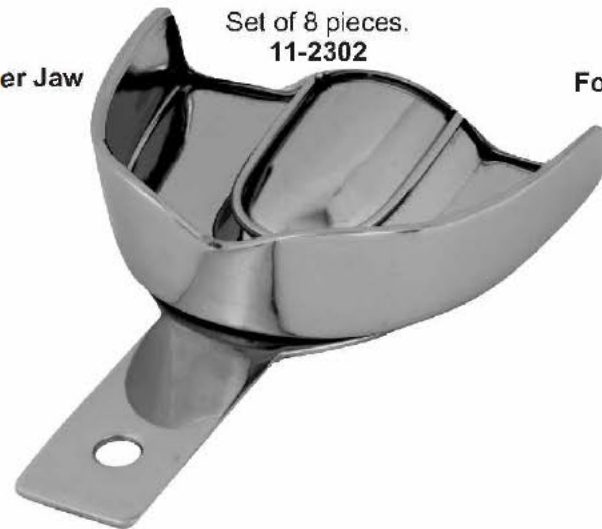

			mm.	mm.
11-2311- U1	XXS	61	47	
11-2312- U2	XS	64	51	
11-2313- U3	S	66	53	
11-2314- U4	M	69	57	
11-2315- U5	L	71	60	
11-2316- U6	XL	73	62	

			mm.	mm.
11-2331- L1	XXS	55	47	
11-2332- L2	XS	60	49	
11-2333- L3	S	72	54	
11-2334- L4	M	74	57	
11-2335- L5	L	76	59	
11-2336- L6	XL	78	61	

Partial impression trays for crown and bridge work.



11-2361- U1P

11-2362- L1P



11-2342- L2D  
11-2344- L4D  
11-2346- L6D

11-2352- L2S  
11-2354- L4S  
11-2356- L6S

Stainless steel "Perforated" impression trays with retention rim.

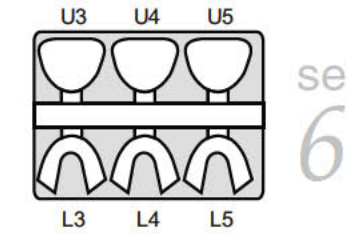

set  
6

Set of 6 pieces.  
11-2401

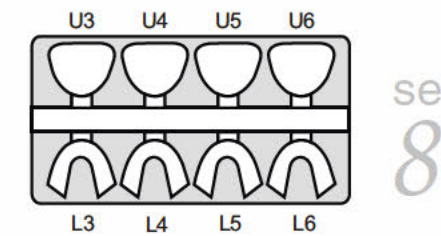
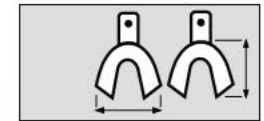
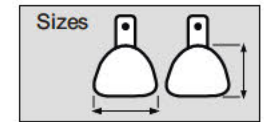

set  
8

Set of 8 pieces.  
11-2402

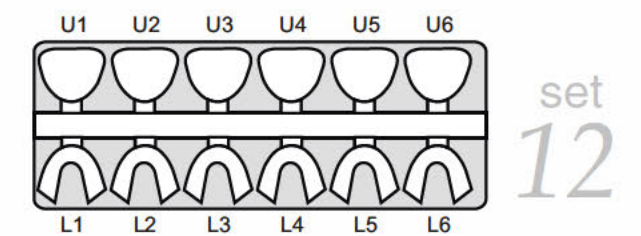

set  
12

Set of 12 pieces.  
11-2404

For Upper Jaw

For Lower Jaw

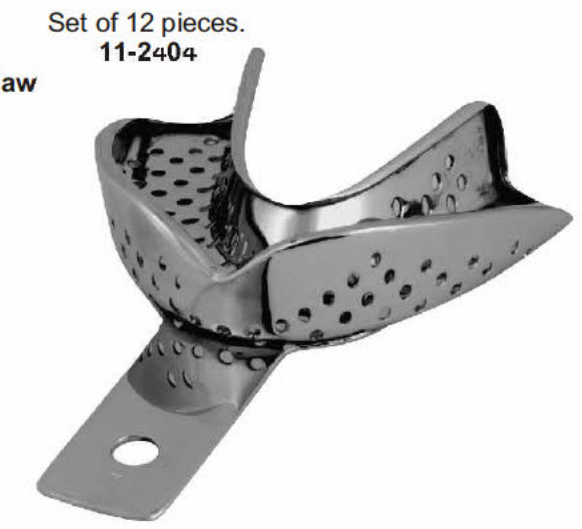
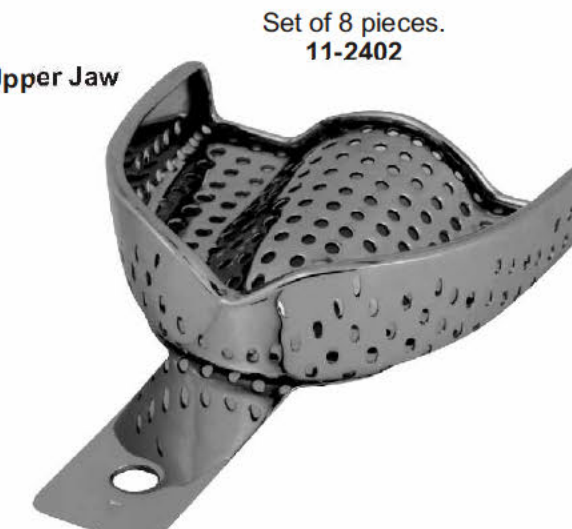

			mm.	mm.
11-2411- U1	XXS	61	47	
11-2412- U2	XS	64	51	
11-2413- U3	S	66	53	
11-2414- U4	M	69	57	
11-2415- U5	L	71	60	
11-2416- U6	XL	73	62	

			mm.	mm.
11-2431- L1	XXS	55	47	
11-2432- L2	XS	60	49	
11-2433- L3	S	72	54	
11-2434- L4	M	74	57	
11-2435- L5	L	76	59	
11-2436- L6	XL	78	61	

Partial impression trays for crown and bridge work.

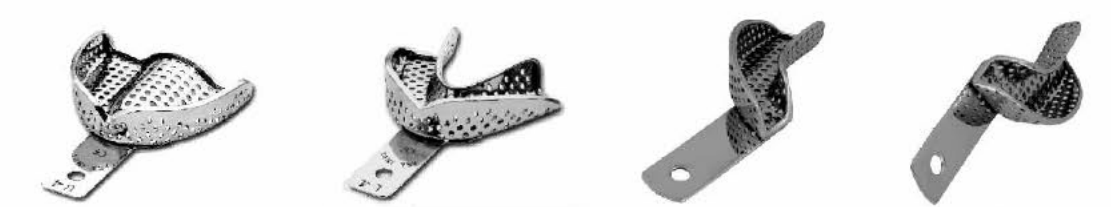

11-2461- U1P

11-2462- L1P

11-2442- L2D  
11-2444- L4D  
11-2446- L6D

11-2452- L2S  
11-2454- L4S  
11-2456- L6S

Stainless Steel

INOX  
18/08

Anteriorly depressed with retention rim.  
 Stainless Steel "Solid"

"Solid" stainless steel

For Upper Jaw

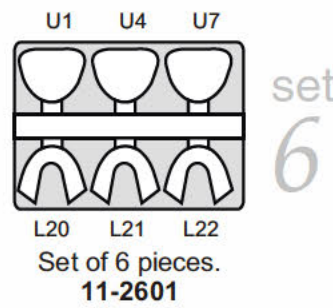

			mm.	mm.
11-2611- U1	L		81	67
11-2614- U4	M		71	64
11-2617- U7	S		70	57

For Lower Jaw



			mm.	mm.
11-2631- L20	L		81	60
11-2634- L21	M		79	57
11-2637- L22	S		76	54

Anteriorly depressed with retention rim.  
 Stainless steel "Perforated"

"Perforated" stainless steel

For Upper Jaw

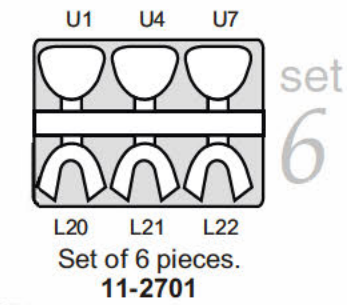

			mm.	mm.
11-2711- U1	L		81	67
11-2714- U4	M		71	64
11-2717- U7	S		70	57

For Lower Jaw



			mm.	mm.
11-2731- L20	L		81	60
11-2734- L21	M		79	57
11-2737- L22	S		76	54

Impression Trays  
Abdrucklöffler  
Portamoldes  
Porte-empreintes  
Porta-impronte

Stainless Steel

INOX  
18/08

Stainless steel "Solid" impression trays without retention rim.

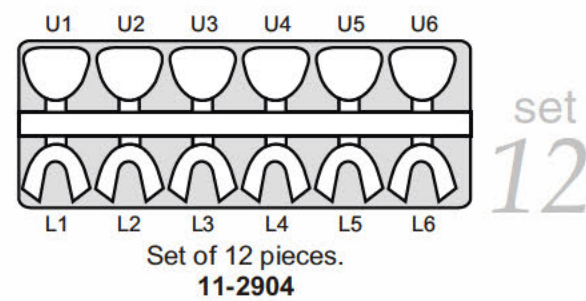
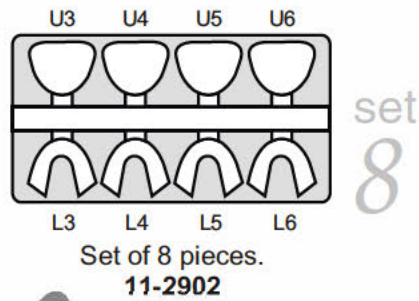
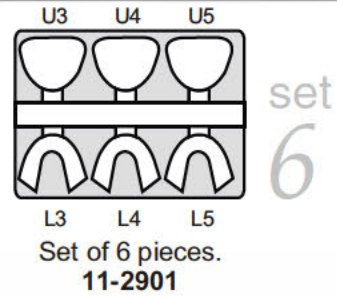

For Upper Jaw

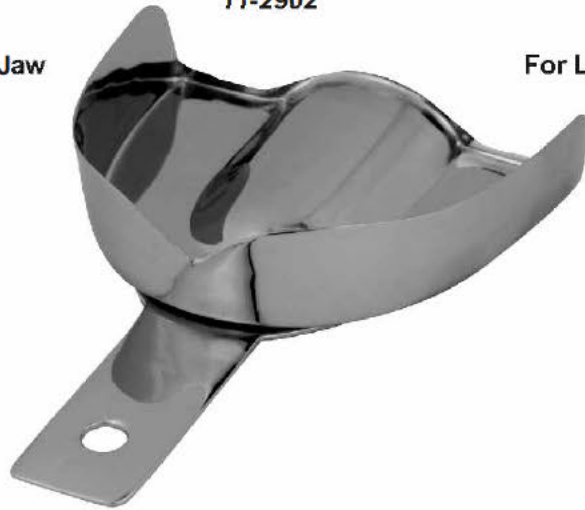

For Lower Jaw



		mm.	mm.
11-2911- U1	XXS	61	47
11-2912- U2	XS	64	51
11-2913- U3	S	66	53
11-2914- U4	M	69	57
11-2915- U5	L	71	60
11-2916- U6	XL	73	62

		mm.	mm.
11-2931- L1	XXS	55	47
11-2932- L2	XS	60	49
11-2933- L3	S	72	54
11-2934- L4	M	74	57
11-2935- L5	L	76	59
11-2936- L6	XL	78	61

Partial impression trays for crown and bridge work.



11-2942- L2D  
11-2944- L4D  
11-2946- L6D



11-2952- L2S  
11-2954- L4S  
11-2956- L6S

Impression Trays  
Abdrucklöffler  
Portamoldes  
Porte-empreintes  
Porta-impronte

Stainless steel "Perforated" impression trays without retention rim.

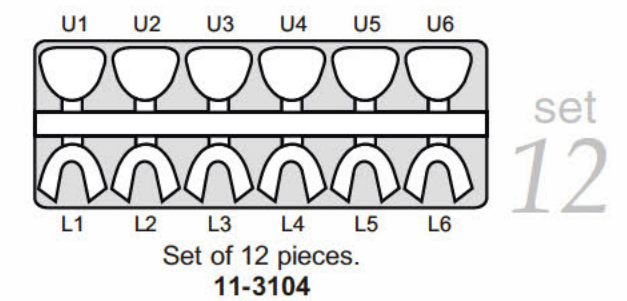
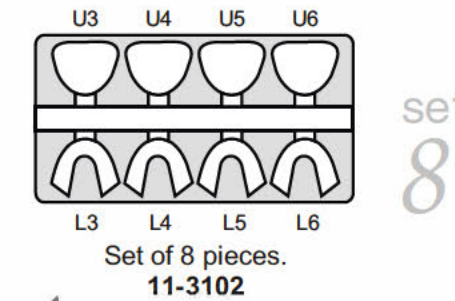
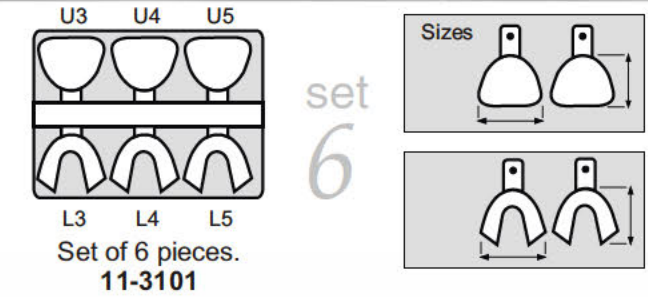

For Upper Jaw

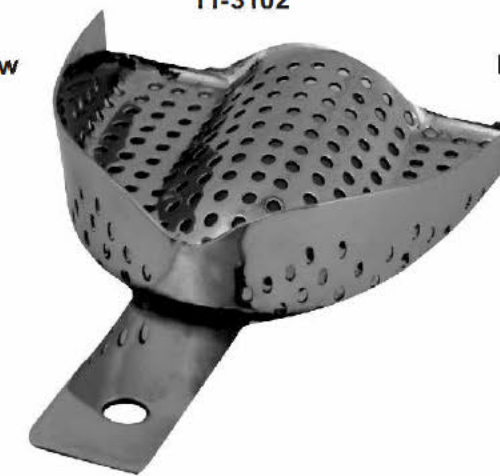

For Lower Jaw



		mm.	mm.
11-3111- U1	XXS	61	47
11-3112- U2	XS	64	51
11-3113- U3	S	66	53
11-3114- U4	M	69	57
11-3115- U5	L	71	60
11-3116- U6	XL	73	62

		mm.	mm.
11-3131- L1	XXS	55	47
11-3132- L2	XS	60	49
11-3133- L3	S	72	54
11-3134- L4	M	74	57
11-3135- L5	L	76	59
11-3136- L6	XL	78	61

Partial impression trays for crown and bridge work.



11-3142- L2D  
11-3144- L4D  
11-3146- L6D



11-3152- L2S  
11-3154- L4S  
11-3156- L6S

Impression Trays  
 Abdrucklöffler  
 Portamoldes  
 Porte-empreintes  
 Porta-impronte

CH 11 | www.surgical-i.com

**EHRICKE Stainless steel impression trays.**

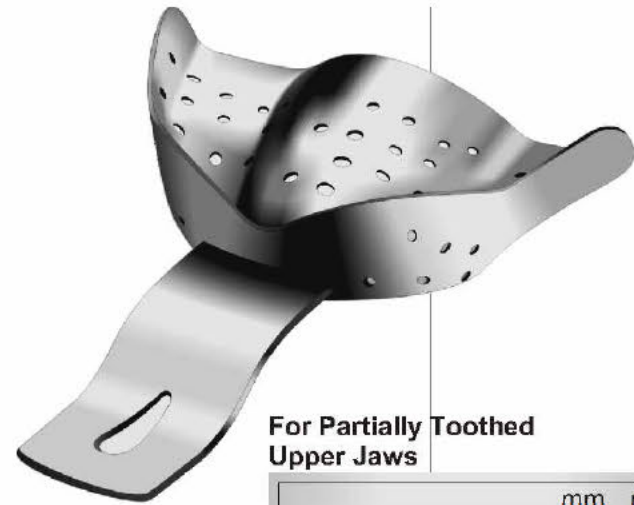
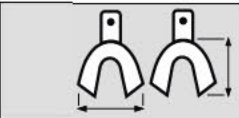
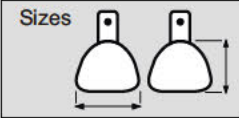

For Partially Toothed Upper Jaws

	mm.	mm.
11-3711- OP1	62	50
11-3712- OP2	70	56

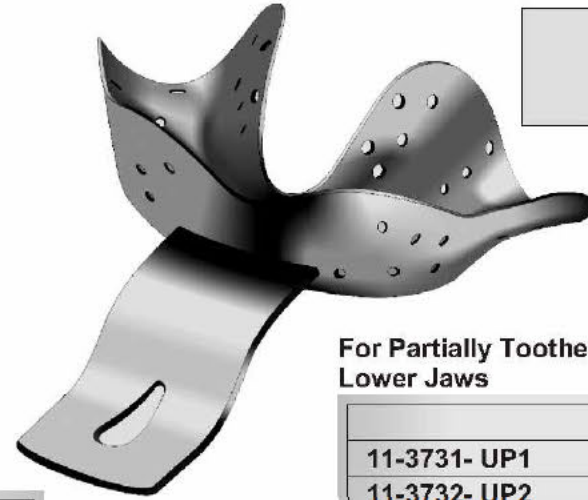

For Partially Toothed Lower Jaws

	mm.	mm.
11-3731- UP1	70	55
11-3732- UP2	78	59

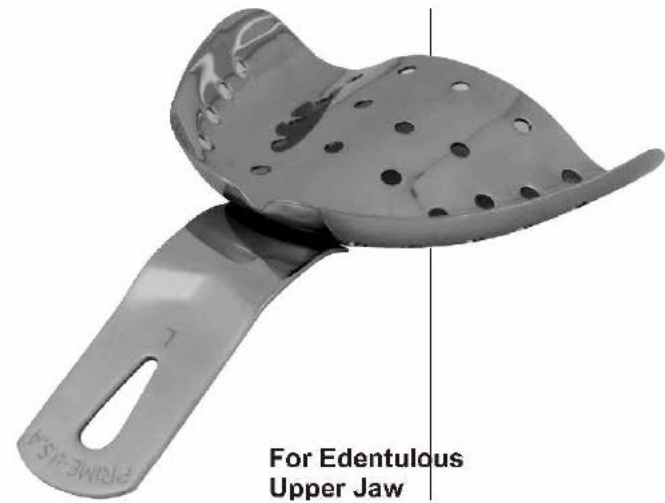

For Edentulous Upper Jaw

	mm.	mm.
11-3811- OU1	64	46
11-3814- OU2	68	53
11-3817- OU3	79	61

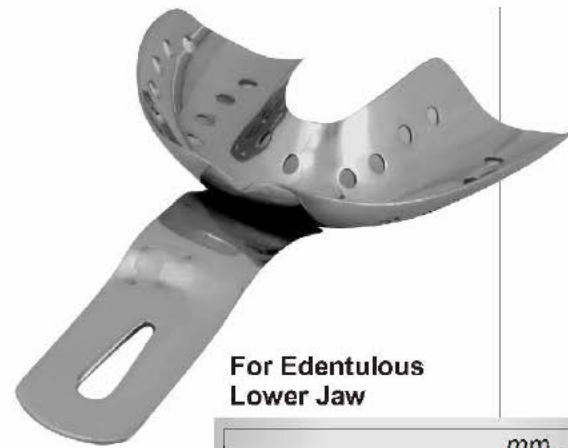

For Edentulous Lower Jaw

	mm.	mm.
11-3831- UU1	70	48
11-3834- UU2	70	53
11-3837- UU3	72	57

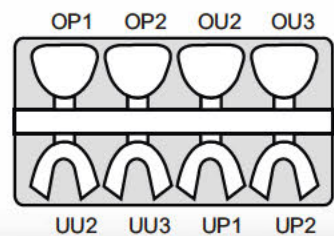

set  
8

Set of 8 pieces.  
11-3702

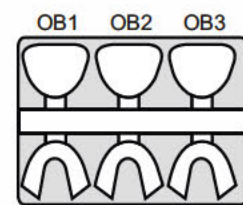

set  
6

Set of 6 pieces.  
11-3801

# CH 12



**Pliers For Orthodontics**  
 Zangen für Kieferorthopädie  
 Pinzas para ortodoncia  
 Pinces pour orthodontie  
 Pinze Ortodontiche



Flat Nose Pliers

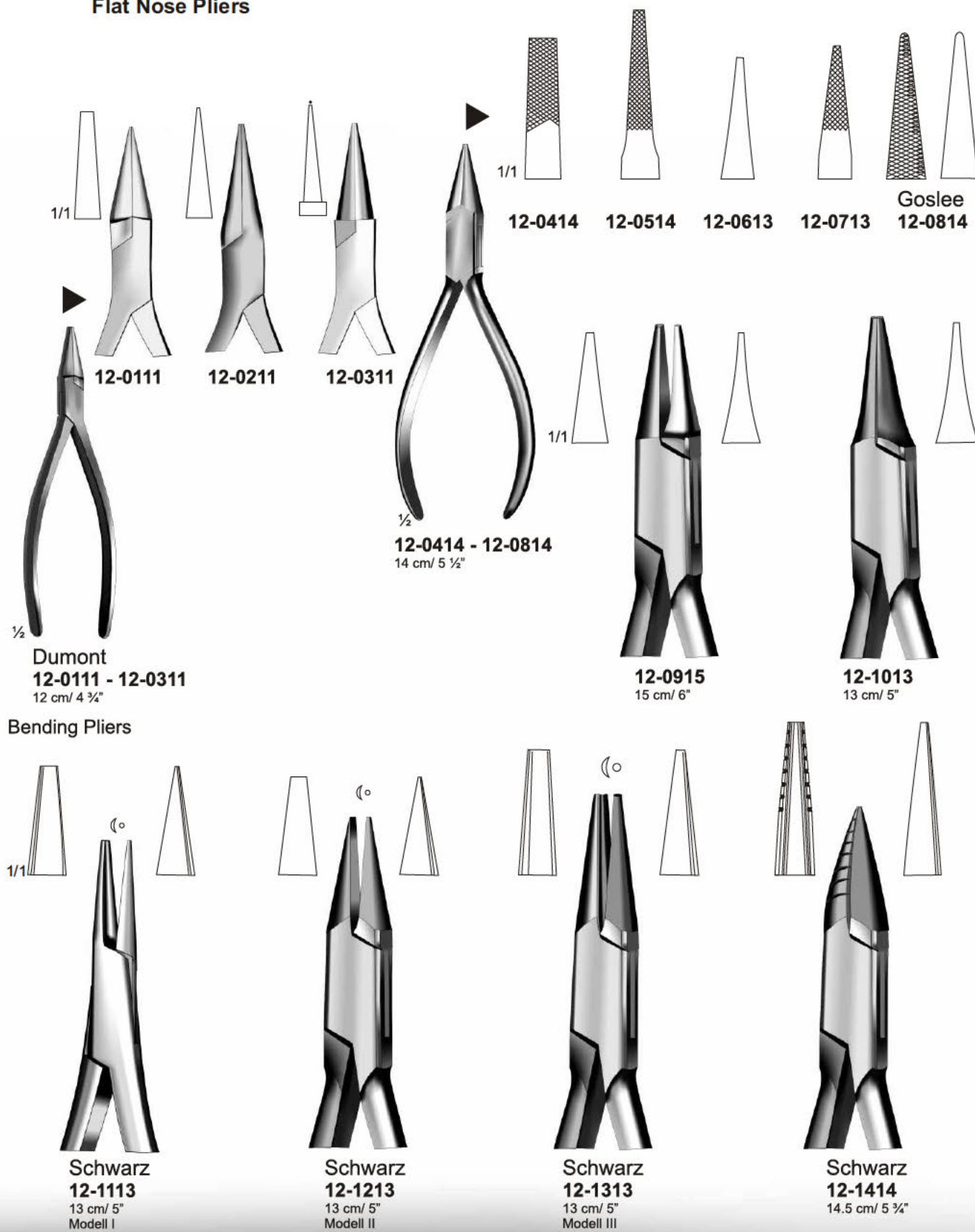

End and Side Nippers



Wire, Arch and clasp bending pliers

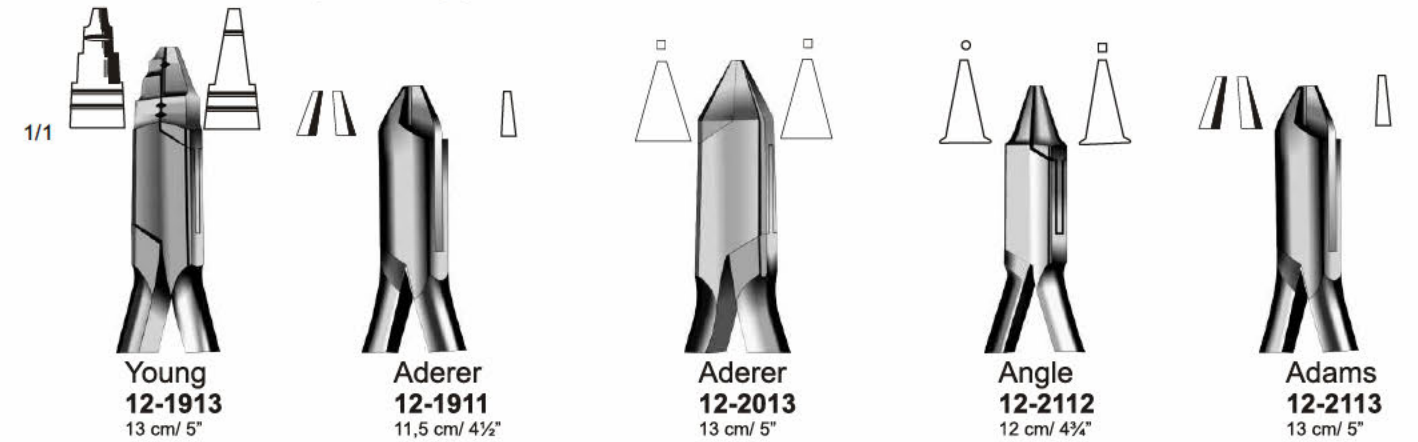

Crown Pliers, Contouring Pliers

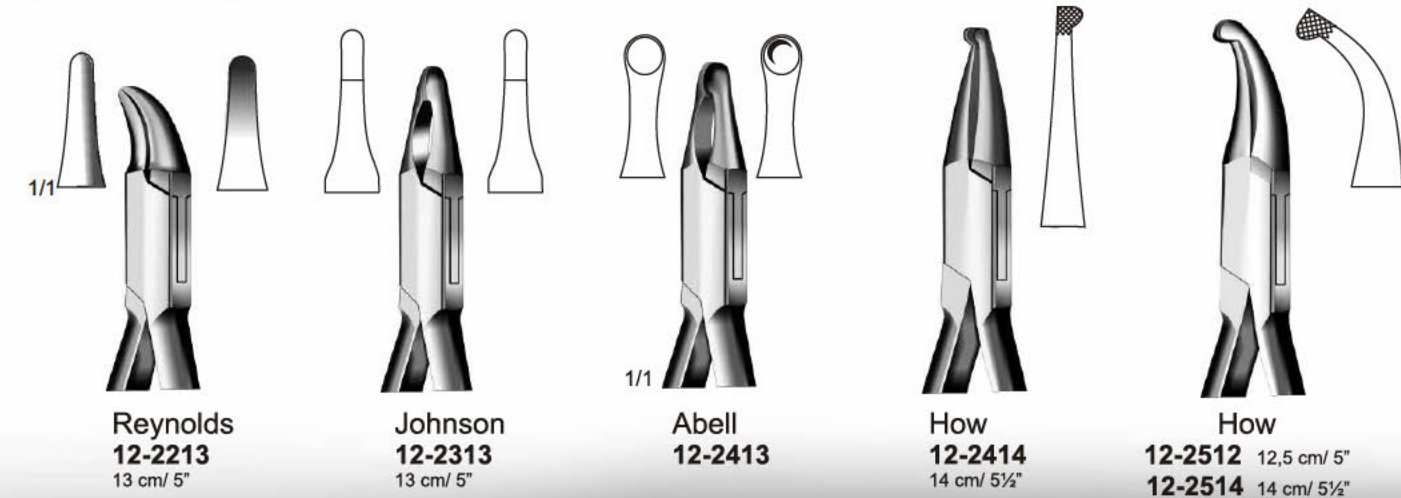

Universal Pliers, Copper Ring and Bridge Removing Pliers

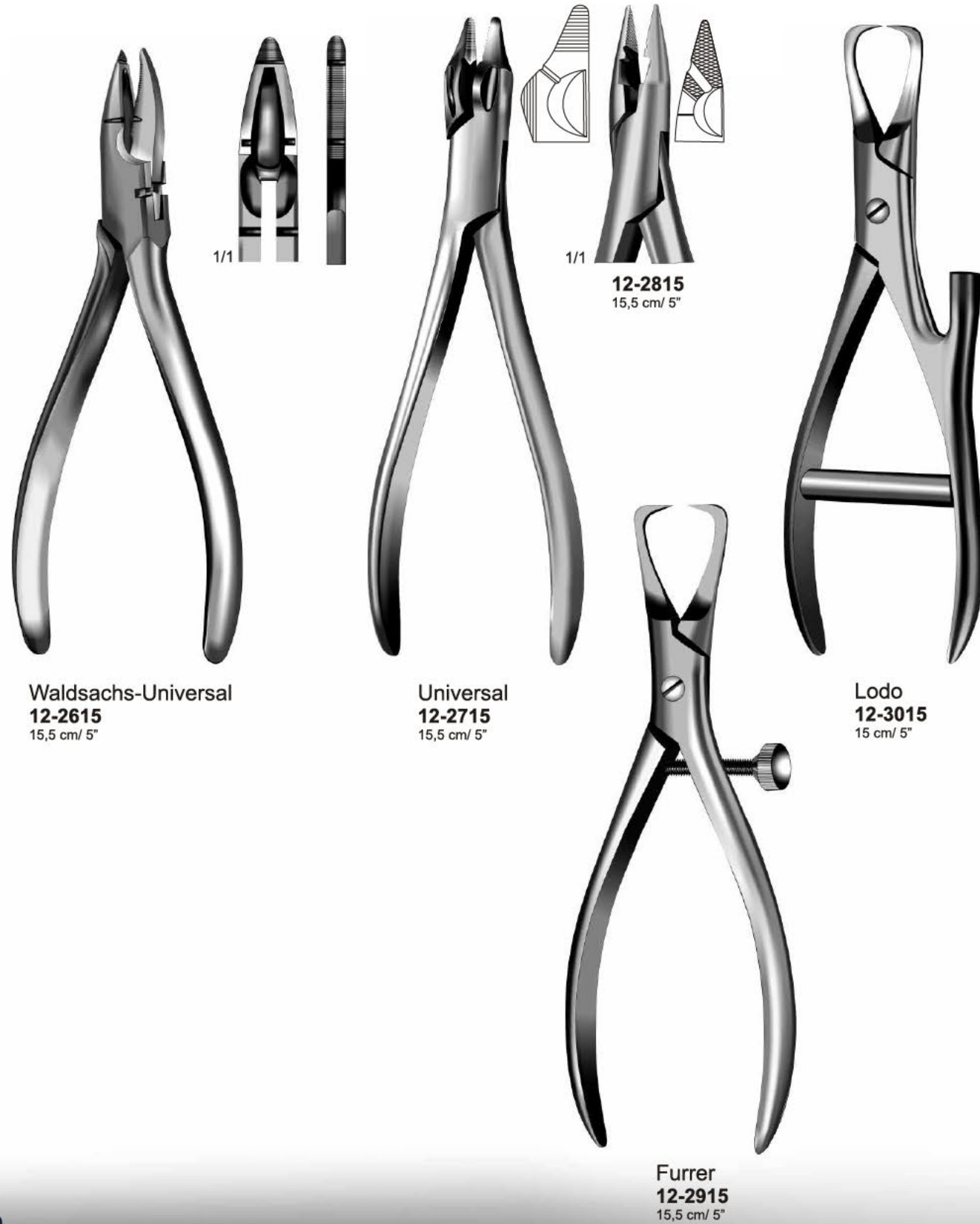

Waldsachs-Universal  
**12-2615**  
 15,5 cm/ 5"

Universal  
**12-2715**  
 15,5 cm/ 5"

Furrer  
**12-2915**  
 15,5 cm/ 5"

Lodo  
**12-3015**  
 15 cm/ 5"

**12-2815**  
 15,5 cm/ 5"

Band Seating & Arch Bending Pliers

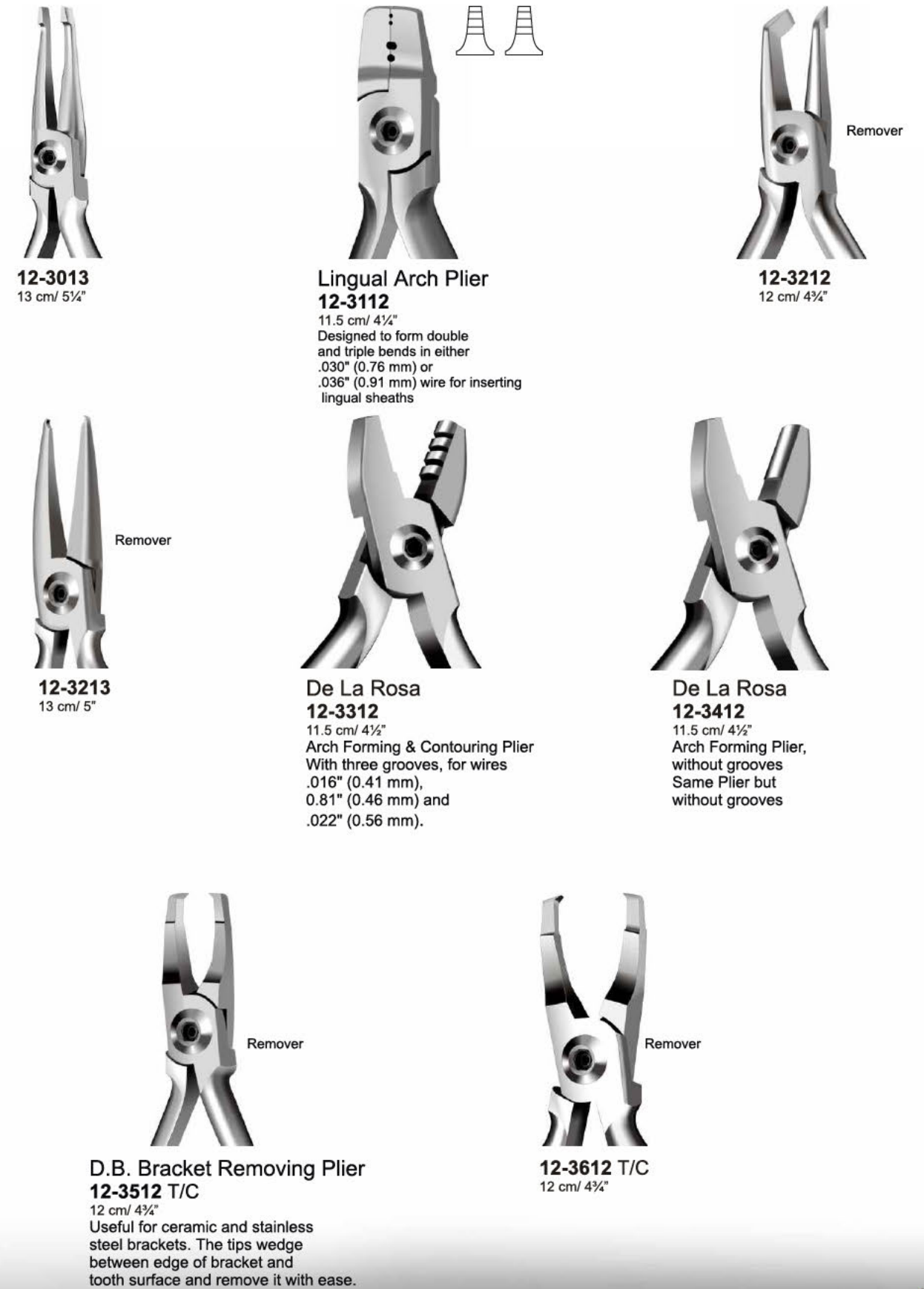

**12-3013**  
 13 cm/ 5 1/4"

Lingual Arch Plier  
**12-3112**  
 11.5 cm/ 4 1/2"  
 Designed to form double and triple bends in either .030" (0.76 mm) or .036" (0.91 mm) wire for inserting lingual sheaths

**12-3212**  
 12 cm/ 4 3/4"

**12-3213**  
 13 cm/ 5"

De La Rosa  
**12-3312**  
 11.5 cm/ 4 1/2"  
 Arch Forming & Contouring Plier  
 With three grooves, for wires .016" (0.41 mm), .081" (0.46 mm) and .022" (0.56 mm).

De La Rosa  
**12-3412**  
 11.5 cm/ 4 1/2"  
 Arch Forming Plier, without grooves  
 Same Plier but without grooves

D.B. Bracket Removing Plier  
**12-3512 T/C**  
 12 cm/ 4 3/4"  
 Useful for ceramic and stainless steel brackets. The tips wedge between edge of bracket and tooth surface and remove it with ease.

**12-3612 T/C**  
 12 cm/ 4 3/4"

**Bond Bracket**



**12-3712 T/C**  
 12 cm/ 4 3/4"



**12-3812 T/C**  
 12 cm/ 4 3/4"



**12-3912 T/C**  
 12 cm/ 4 3/4"



**D.B. Bracket Removing Plier, with Pad**  
**12-4012 T/C**  
 12 cm/ 4 3/4"  
 Designed for quick and comfortable removal of direct bond brackets. It will also remove adhesive from the tooth.



**Posterior Band Removing Plier, Long**  
**12-4112 T/C**  
 12 cm/ 4 3/4"  
 Will remove band with maximum patient comfort. The tip is postured in the middle of the pad for band removal ease. A plastic padded tip and a sharp removing beak allow, with a slight pressure, easy band removal.

**Wire Bending Pliers**

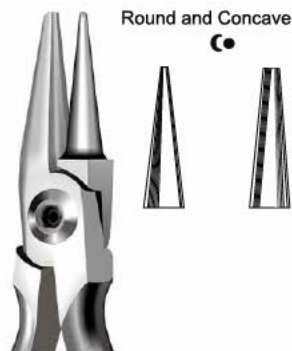

**12-4212**  
 12 cm/ 4 3/4"  
 Medium Wire Plier, Round & Concave Plier  
 For wires up to .28" ( 0.71 mm)

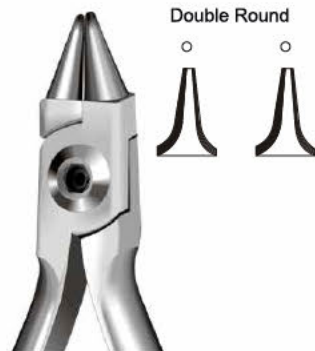

**12-4312**  
 11.5 cm/ 4 1/2"  
 Double Rounded Jaw Plier  
 For wires up to .030".

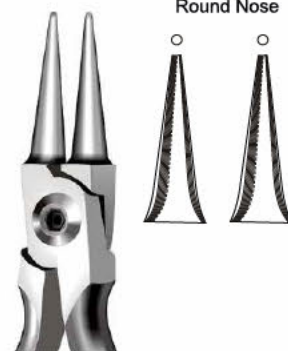

**12-4412**  
 12 cm/ 4 3/4"

**Wire Bending Pliers**

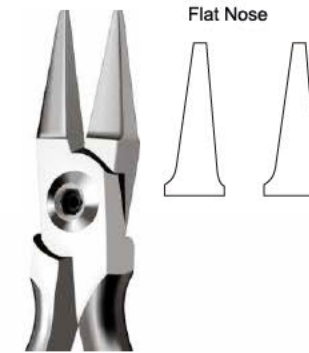

**Jarabak**  
**12-4413**  
 12.5 cm/ 5"  
 Excellent for precise bending of light wires. Precision grooves assure accurate bending and closing loops. Wires up to .020".



**Reynolds**  
**12-4512**  
 12 cm/ 4 3/4"

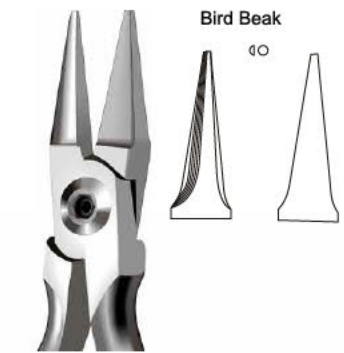

**Light Wire Plier**  
**12-4513**  
 12.5 cm/ 5"  
 The beaks are more tapered and longer than Angle Plier. Excellent for bending small diameter loops. Used for wires up to .016" ( 0.41 mm)

**Wire Arch Bending & Forming Pliers**



**Tweed**  
**12-4611 T/C**  
 11.5 cm/ 4 1/2"  
 Rectangular Arch Pliers, Tweed Style  
 Forming plier for square or rectangular wires. The blades are designed to be parallel at .020" ( 0.51 mm) opening. The working edges are carefully diamond-honed to prevent wire scoring.



**Tweed(Angle)**  
**12-4612 T/C**  
 12 cm/ 4 3/4"



**Tweed(Angle)**  
**12-4711 T/C**  
 11 cm/ 4 1/2"



**12-4811 T/C**  
 11 cm/ 4 1/2"

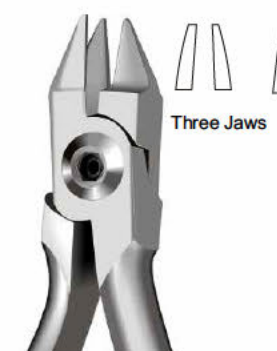

**Aderer**  
**12-4812**  
 11.5 cm/ 4 1/2"  
 Three Jaw Thin Plier,  
 For wires up to .028" ( 0.71 mm ).

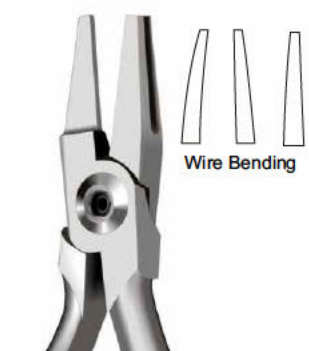

**Aderer**  
**12-4912**  
 12 cm/ 4 3/4"  
 Three Jaw Plier, Aderer  
 The precision aligned tips ensure for consistent bends. Gradually tapered for delicate bending. For wires up to 0.036" ( 0.91 mm )

Wire Arch Bending & Forming Pliers



**How 12-4913**  
 13 cm / 5 1/4"  
 Utility Plier, How Long well tapered shape. With 3/32" ( 2.4mm) gripping pads which are serrated and shaped, so that their centre line coincides with the axis of rotation of the plier and holds the wire securely. Beaks are rounded to be completely lip safe.



**How 12-5013**  
 12.5 cm / 4 3/4"  
 Utility Plier, How Style With 1/8" ( 3.2 mm ) gripping pads, which are serrated to hold wire securely. Beaks are completely lip safe.



**Weingart 12-5113 T/C**  
 12.5 cm / 4 3/4"  
 Utility Plier, Weingart Classic design, generally utility plier. Pointed serrated tips. Holds wire firmly at convenient angle. The beaks are rounded to make the plier completely mouth safe. Useful for removal of ceramics

Loop Forming /Bending Pliers

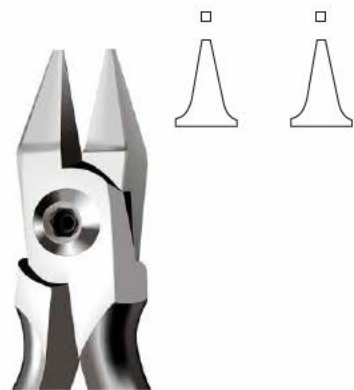

**Adams 12-5212**  
 12 cm / 4 3/4"

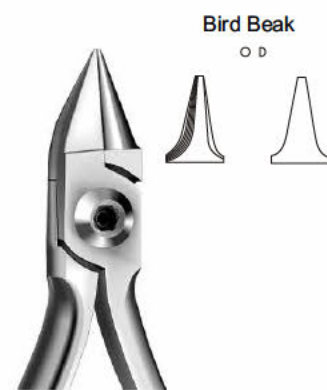

**Angle 12-5312**  
 11.5 cm / 4 1/2"  
 Bird Beaks Pliers, Angle It is used for working round wires up to .030" ( 0.76 mm) in diameter. The beaks are .025" ( 0.64 mm) at the tip. The beaks are parallel at 0.20" ( 0.51 mm) opening.

Loop Forming /Bending Pliers



**Mckellops Plier 12-5313**  
 12.5 cm / 5 1/4"  
 For wires up to .059" ( 1.5 mm).



Tweed Loop Forming



**Tweed 12-5413**  
 12.5 cm / 5 1/4"  
 Loop Forming, Tweed Style Pliers Designed for making loops in round or rectangular wires up to 0.022x0.028" ( 0.56 x 0.71 mm ). The cylindrical beak has three sections: 0.045" (1.14mm), .060" ( 1.52mm), .075" ( 1.90mm). Each section is 0.090" in length. The concave beak has slight parallel serrations which orient and keep the wire at a right angle to the beaks while the loop is being formed.



Omega Loop Forming



**Tweed 12-5513**  
 12.5 cm / 5 1/4"  
 Omega Loop Forming Pliers, Tweed Style It just differs from the Model 12-5413 in the concave beak which is rounded for making more uniform omega loops.



Single Diameter Loop Forming



**Tweed 12-5613**  
 12.5 cm / 5 1/4"



**12-6612**  
 Loop Closing Plier, Nance Style Box joint with 4 sectioned tip for forming various size loops in rectangular and round wires. For wires up to .028" ( 0.71 mm).



Wire Cutting Pliers



**12-5713 T/C**  
 12.5 cm/ 5"  
 Hard Wire Cutter, Flat Back  
 Cutting capacity up to .020 round,  
 Arch wire up to .022 x .028 and all  
 sizes of ligature wire and pins.



**12-5813 T/C**  
 12.5 cm/ 5"



**12-5913 T/C**  
 13 cm/ 5 1/2"



**12-6012 T/C**  
 12 cm/ 5"



**12-6112 T/C**  
 11.5 cm/ 4 1/2"



**12-6212 T/C**  
 12 cm/ 5"  
 Mini cut & hold distal end cutter  
 cuts with in 0.5mm from end of  
 buccal tube. Use on wire up to  
 0.22" x 0.28" rectangular and  
 0.20" round.



**12-6312 T/C**  
 11.5 cm/ 4 1/2"  
 Distal End Cutter with safety hold  
 It shear cuts hard wire and braided  
 wire and then, safely holds the loose  
 distal ends of the wire, thus preventing  
 from falling down into the oral tissues.  
 The cutting edges are diamond honed.  
 Maximum cutting capacity: rectangular  
 and twist wires up to .022 x .028"  
 ( 0.56 x 0.71); round wire up to .020"  
 ( 0.51 mm) in diameter.

# CH 13-18

**CH 13** Knives, Scalpels  
 Messer, Skalpel  
 Bisturies  
 Bistouris  
 Bisturi

**CH 14** Scissors  
 Scheren  
 Tijeras  
 Ciseaux  
 Forbici

**CH 15** Forceps, Hemostatic Forceps  
 Pinzetten, Arterienklemmen  
 Pinzas, Pinzas hemostaticas  
 Pincers, Pincers hémostatiques  
 Pinzette, Pinze emostatiche

**CH 16** Needle holders  
 Nadel halter  
 Portaguas  
 Porte-aiguilles  
 Porta aghi

**CH 17** Retractors  
 Wundhaken  
 Separadores  
 Ecarteurs  
 Retrattori

**CH 18** Bone Cutting Forceps,  
 Bone Rongeurs  
 Hohlemeißelzangen,  
 Knochen Splitterzangen  
 Pinzas Cortentes para huesos  
 Pincers à os coupantes,  
 Pincers-gouges  
 Scalpellini e pinze alveolotome





Operating Scissors

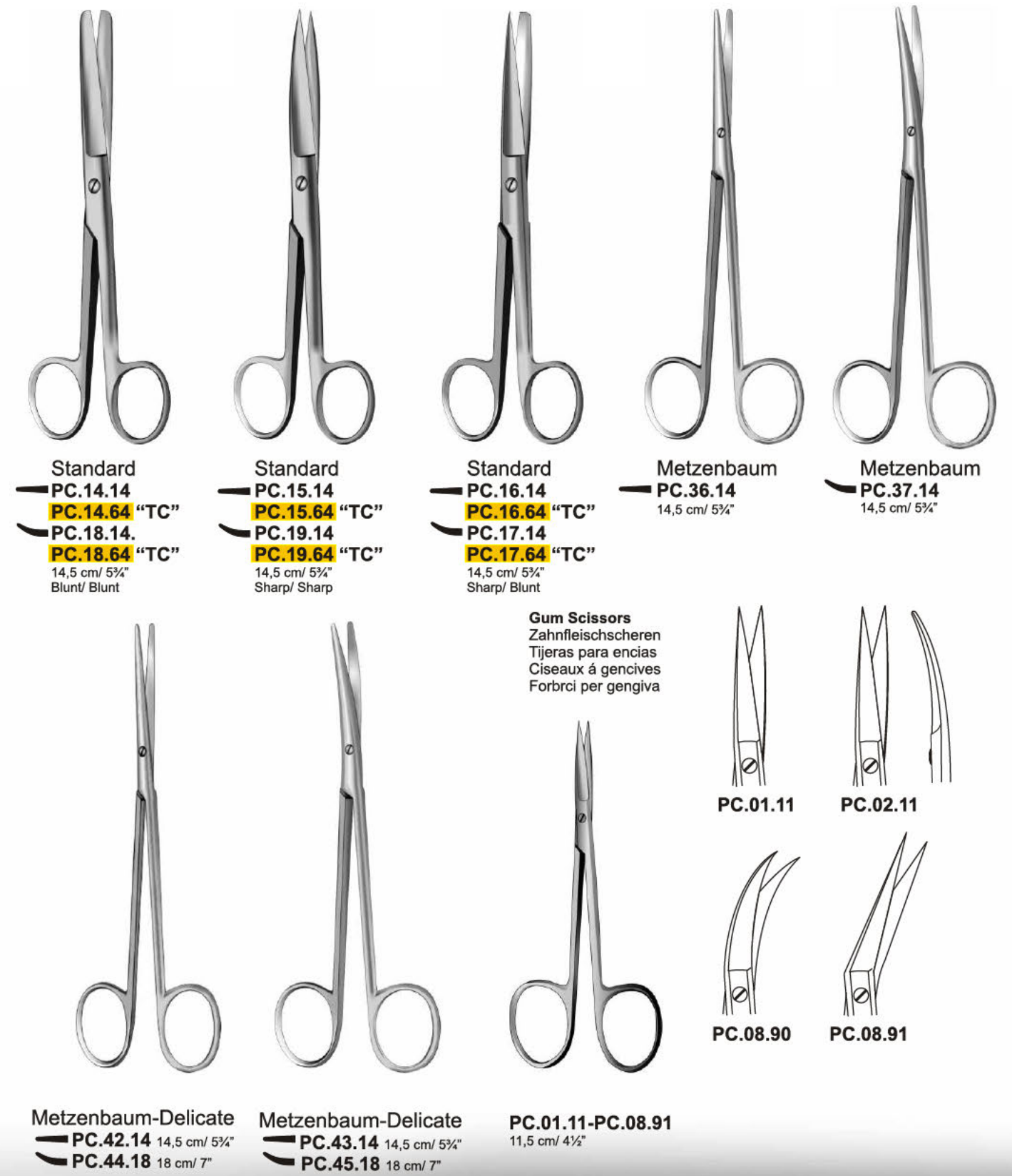

Scissors  
Scheren  
Tijeras  
Ciseaux  
Forbici

**Gum Scissors**  
Zahnfleischscheren  
Tijeras para encias  
Ciseaux á gengives  
Forbici per gengiva

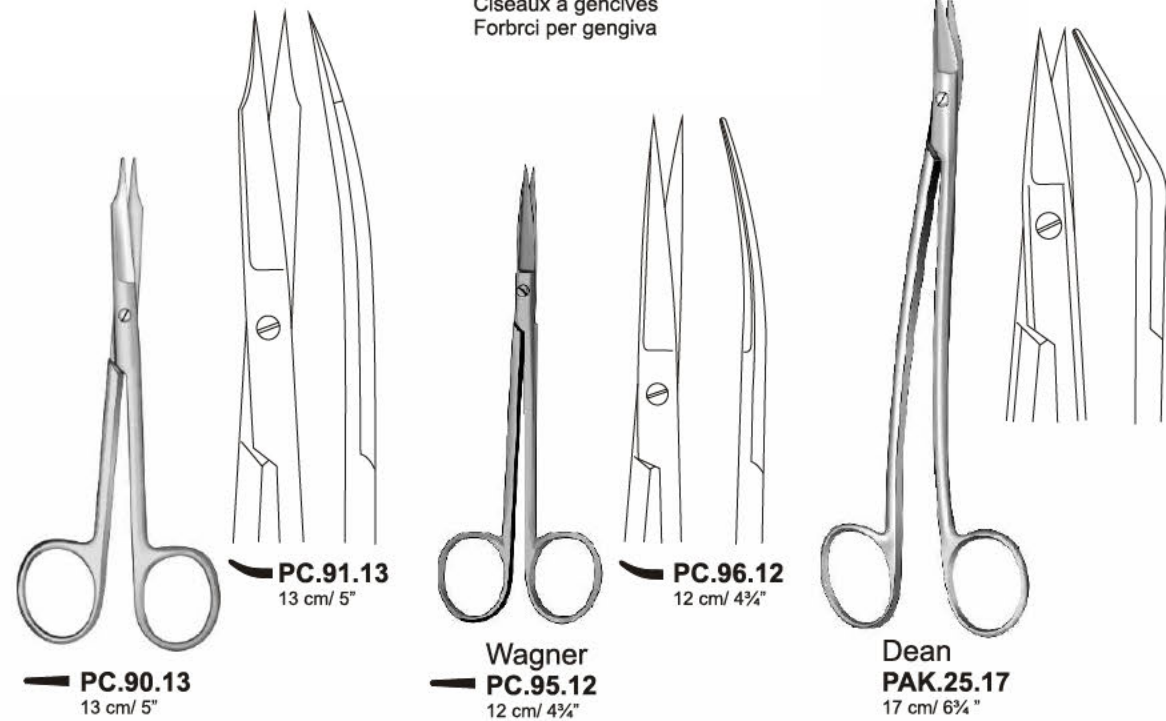

**Wire Cutting Scissors**

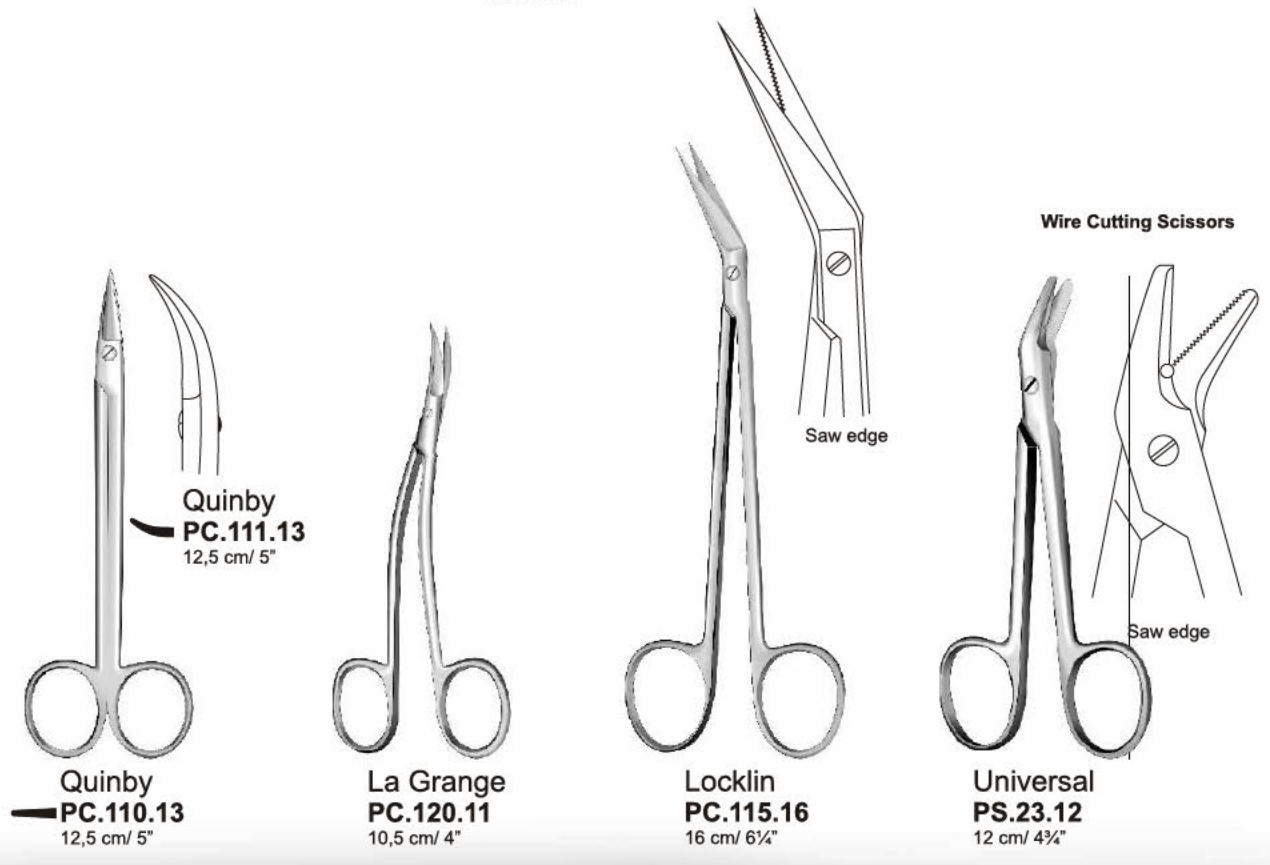

Scissors, with tungsten carbide Inserts  
Scheren mit hartmetall-Einsäten  
Tijeras con plaquitas de carburo de tungsteno  
Ciseaux avec plaquettes en carbure de tungstène  
forbici con placchette in carburo di tungsteno

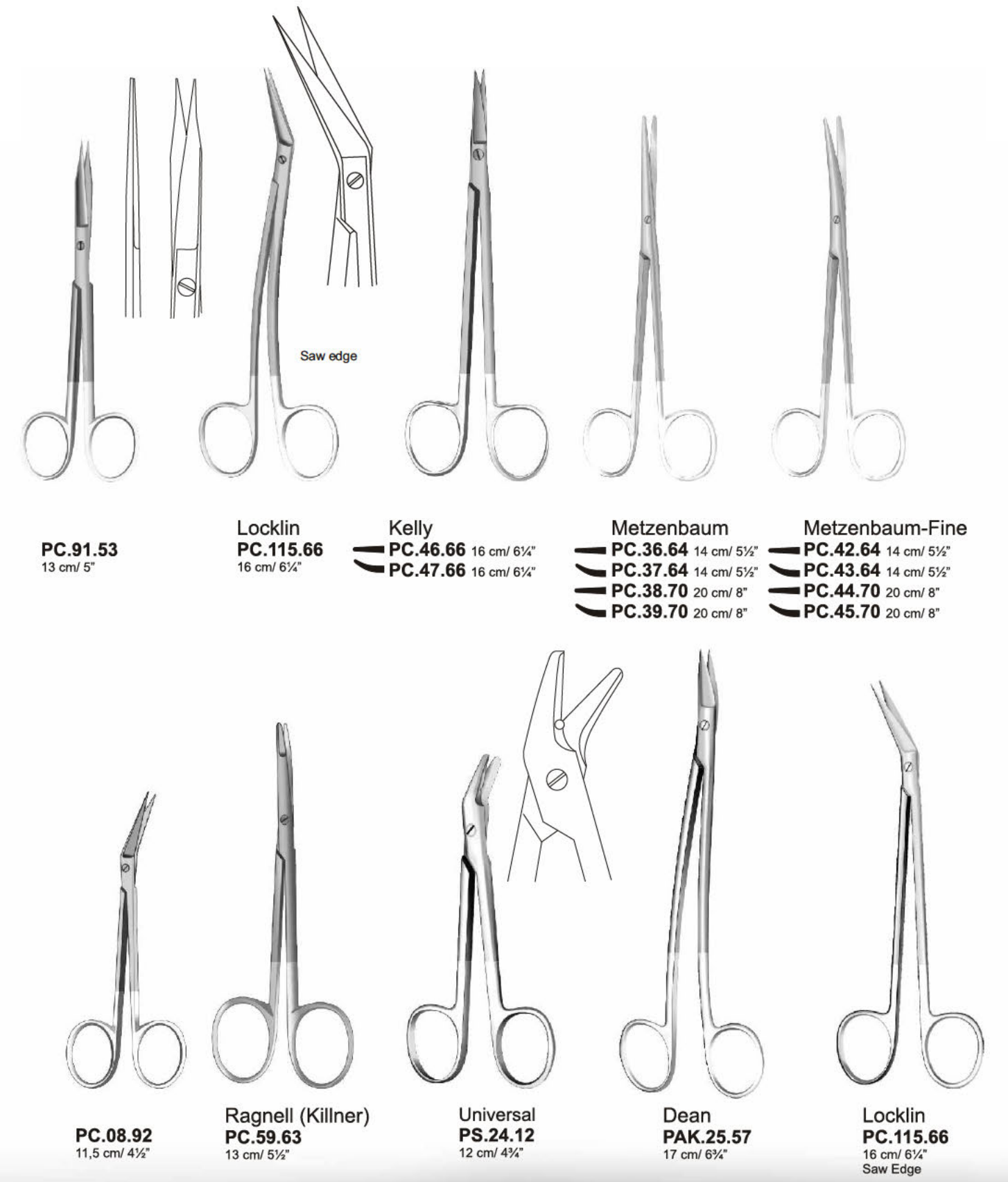

12 cm/ 4 3/4"	<b>PF.01.11</b>	<b>PF.05.11</b>	<b>PF.15.12</b>		
14.5cm/ 5 3/4"	<b>PF.01.14</b>	<b>PF.05.14</b>			
15cm/ 6"	<b>PF.01.15</b>	<b>PF.05.15</b>	<b>PF.15.15</b>		
16 cm/ 6 1/4"	<b>PF.01.16</b>	<b>PF.05.16</b>			
18 cm/ 7"	<b>PF.01.18</b>	<b>PF.05.18</b>			
20 cm/ 8"	<b>PF.01.20</b>	<b>PF.05.20</b>			
25 cm/ 10"	<b>PF.01.25</b>	<b>PF.05.25</b>			

Standard  
Standard  
Adson  
Semken  
Adson  
Adson Brown

12 cm/ 4 3/4"  
15.5 cm/ 6"  
12 cm/ 4 3/4"  
15 cm/ 6"

With Tungsten Carbide "TC"

12 cm/ 4 3/4"	<b>PF.01.62</b>	<b>PF.03.62</b>	<b>PF.15.62</b>	
14.5cm/ 5 3/4"	<b>PF.01.64</b>	<b>PF.03.64</b>		
15cm/ 6"	<b>PF.01.65</b>		<b>PF.15.65</b>	
16 cm/ 6 1/4"	<b>PF.01.66</b>	<b>PF.03.66</b>		
18 cm/ 7"	<b>PF.01.68</b>	<b>PF.03.68</b>		

Standard "TC"  
Narrow "TC"  
Adson "TC"  
Cushing "TC"

17cm / 6 1/4"

London College  
15 cm/ 6"  
15-0915 - 15-1515  
WO: Without Lock  
15-0916 - 15-1516  
WL: With Lock

Meriam  
16 cm/ 6 1/4"  
15-1716 - 15-2216  
WO: Without Lock  
15-1717 - 15-2217  
WL: With Lock

Perry  
13 cm/ 5"  
15-2410 Serrated  
15-2413 Smooth

Flagg  
16 cm/ 6 1/4"  
15-1616 Smooth  
15-1626 Serrated

FIG. 1 WO 15-0915 WL 15-0916  
FIG. 2 15-1015 15-1016  
FIG. 3 15-1115 15-1116  
FIG. 4 15-1215 15-1216  
FIG. 5 WO 15-1315 WL 15-1316  
FIG. 6 15-1415 15-1416  
FIG. 7 15-1515 15-1516  
FIG. 1 WO 15-1716 WL 15-1717  
FIG. 2 15-1816 15-1817  
FIG. 3 15-1916 15-1917  
FIG. 4 15-2016 15-2017  
FIG. 5 WO 15-2116 WL 15-2117  
FIG. 6 15-2216 15-2217

Forceps  
Pinzetten  
Pinzas  
Pincas  
Pinces  
Pinzette

CH 15

www.surgical-i.com



Hemostatic Forceps  
Arterienklemmen  
Pinzas hemostaticas  
Pincas hémostatiques  
Pinze emostatiche

www.surgical-i.com

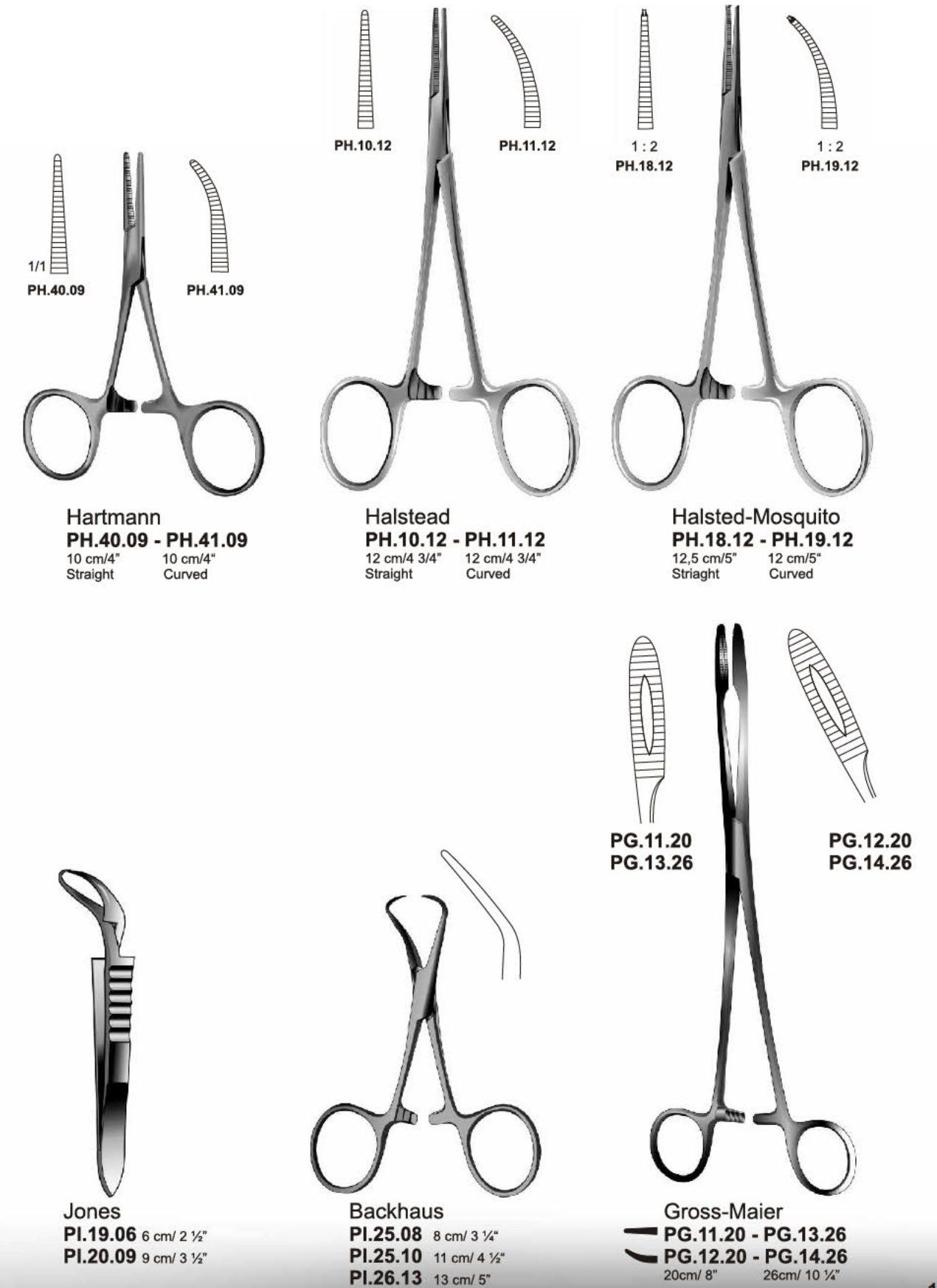

**Needle holders, with Tungsten carbide inserts**  
 Nadelhalter, mit Hartmetalleinsätzen  
 Portaaguas, con bocas de carburo de tungsteno  
 Porte-aiguilles, à mors en carbure de tungstène  
 Porta aghi, con inserti in carburo di tungsteno

**Retractors**  
 Wundhaken  
 Separadores  
 Ecarteurs  
 Retrattori

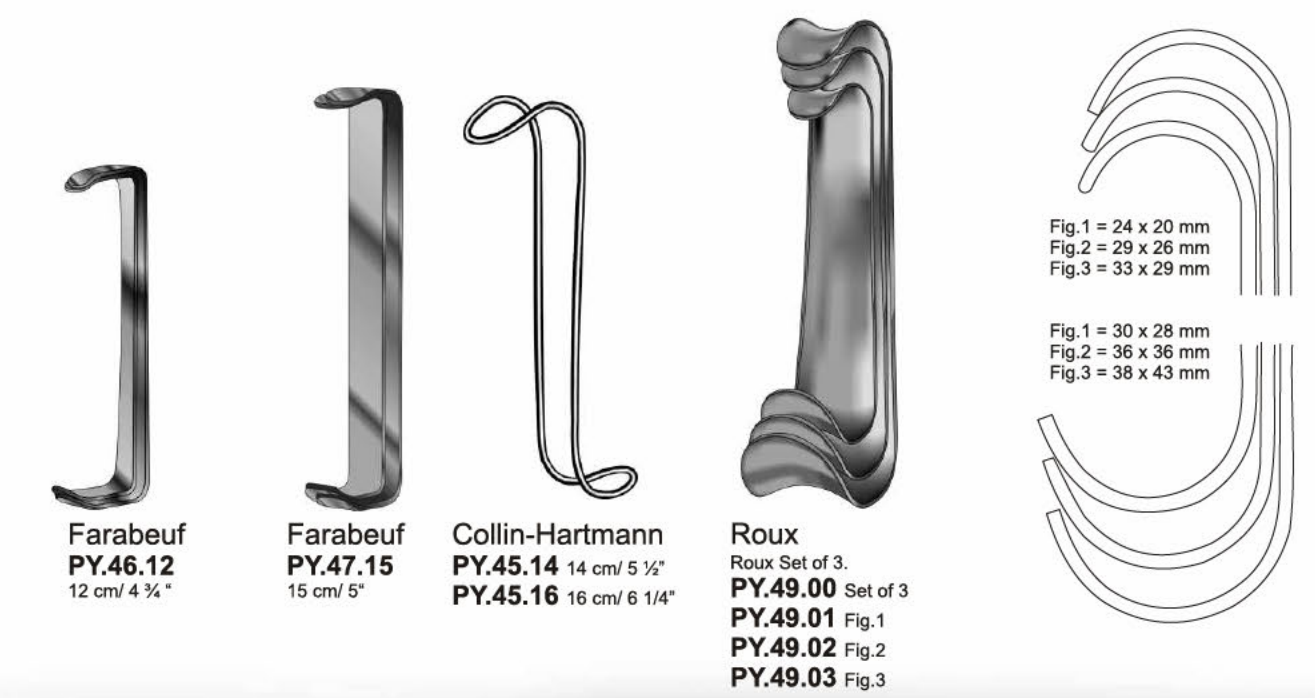
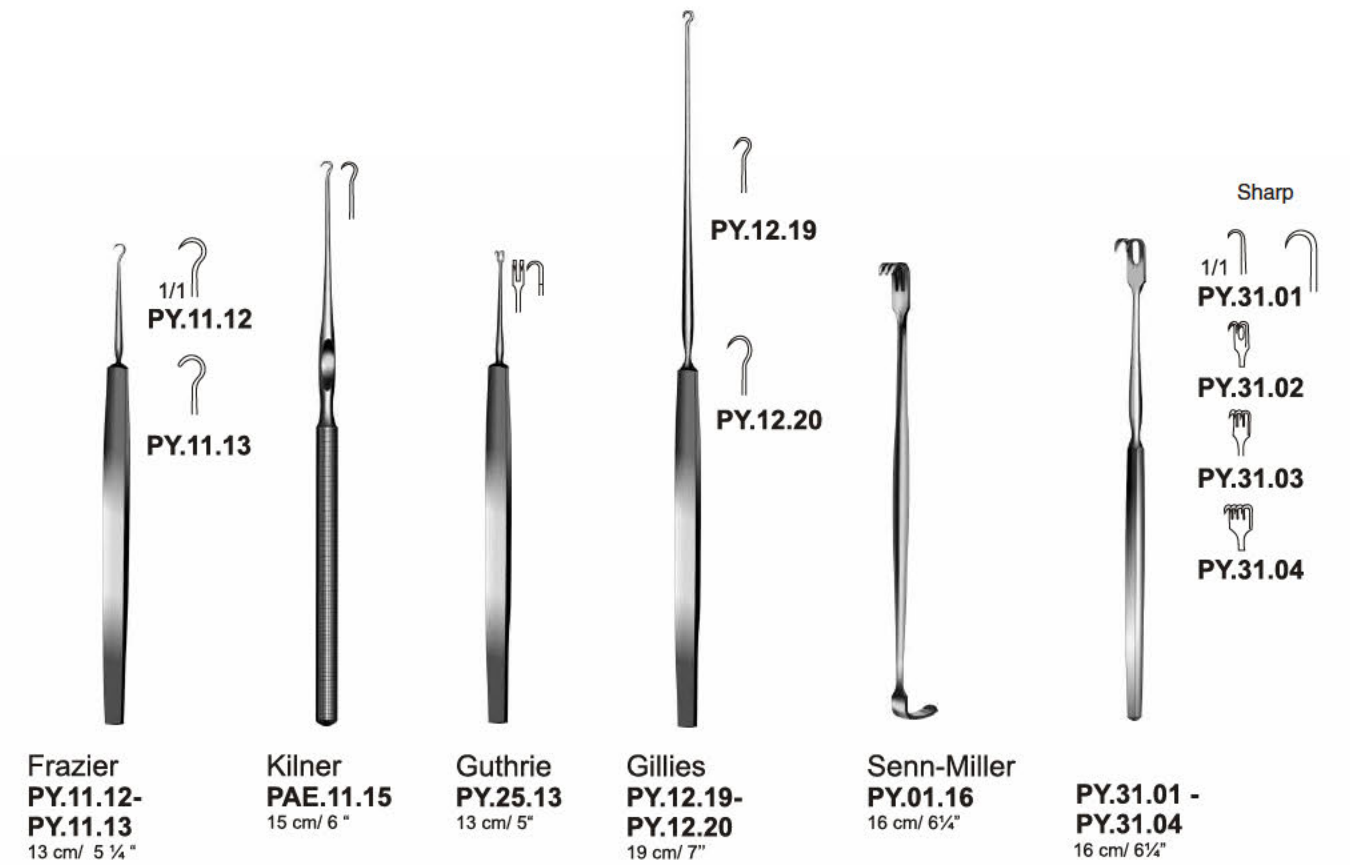
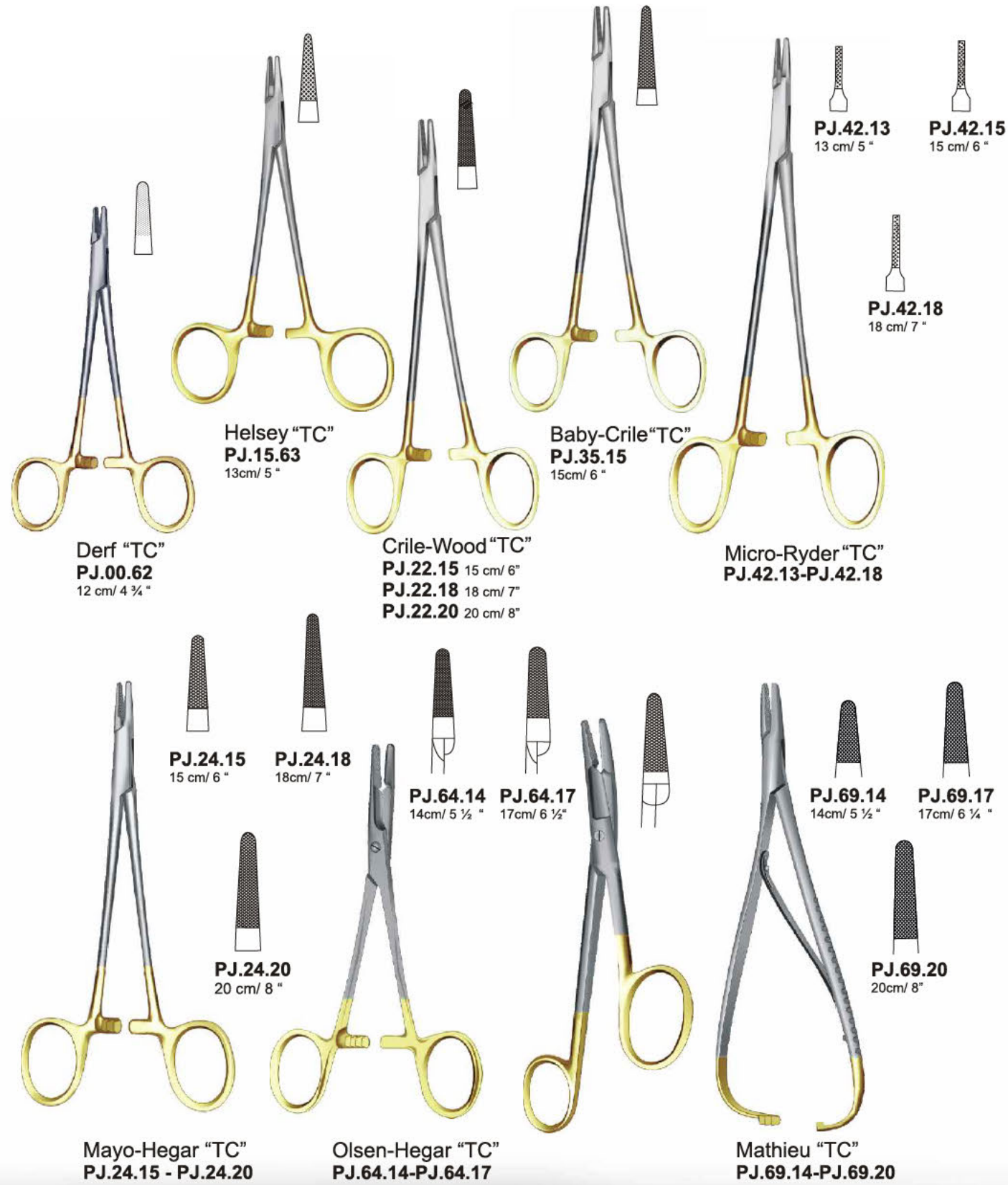

**Retractors**  
 Wundhaken  
 Separadores  
 Ecarteurs  
 Retrattori

**Elevators, Raspatoires**  
 Elevatori, Raspatorii  
 Elevadores, Legras  
 Élévateurs, Rugines  
 Elevatori, Raspe

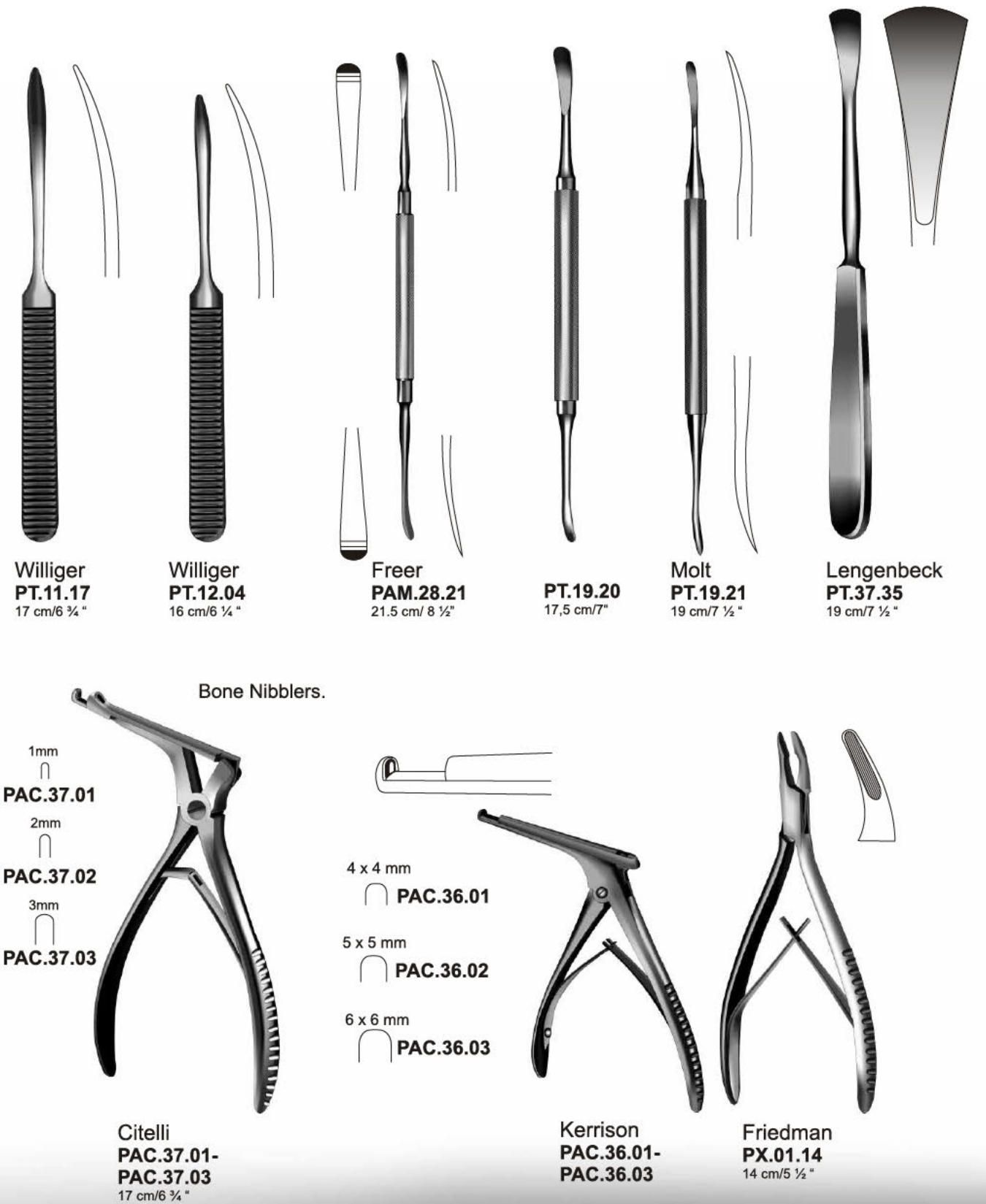
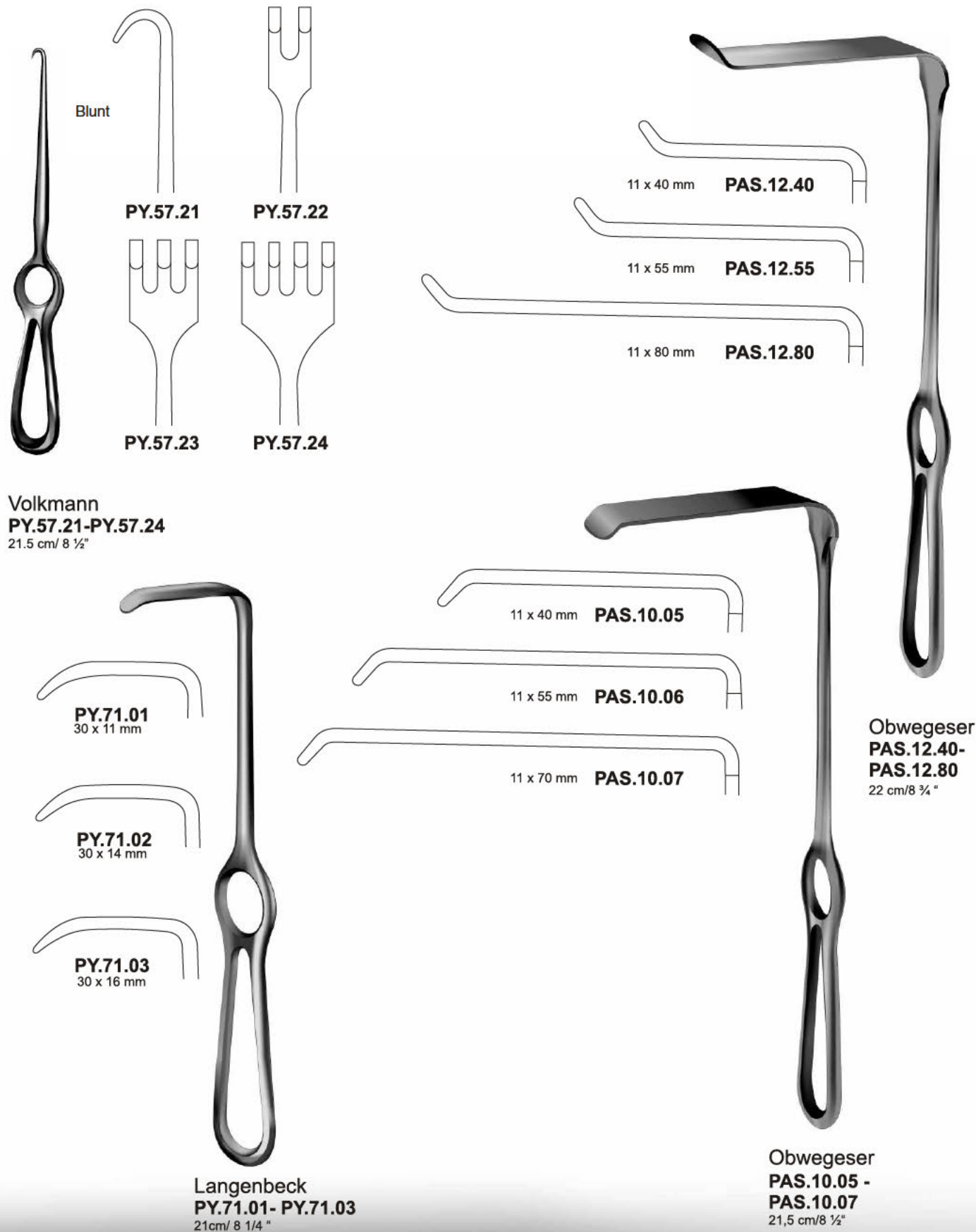

**Bone Cutting Forceps, Bone Rongeurs**  
 Hohlemeißelzangen, Knochen Splitterzangen  
 Pinzas Cortentes para huesos  
 Pincas à os coupantes, Pincas-gouges  
 Scalpellini e pinze alveolotome

**Dermal Punch, Probes, Gauze Packer, Lip Retractor, Tongue, Depressor**  
 Hauttrephinen, Knopfsonden, Tamponstopfer, Lippenhalter, Zungenspatel  
 repanos Cutaneos, esiletes abotonados, Taponadores, Separdores de los labios, Bajaleguas  
 Trépan cutané, Sondes, porte-tampons, Ecarteurs des levres  
 Aspiratori per Soliva, Porta tamponi, Separatore del labbro, Spatola per lingua

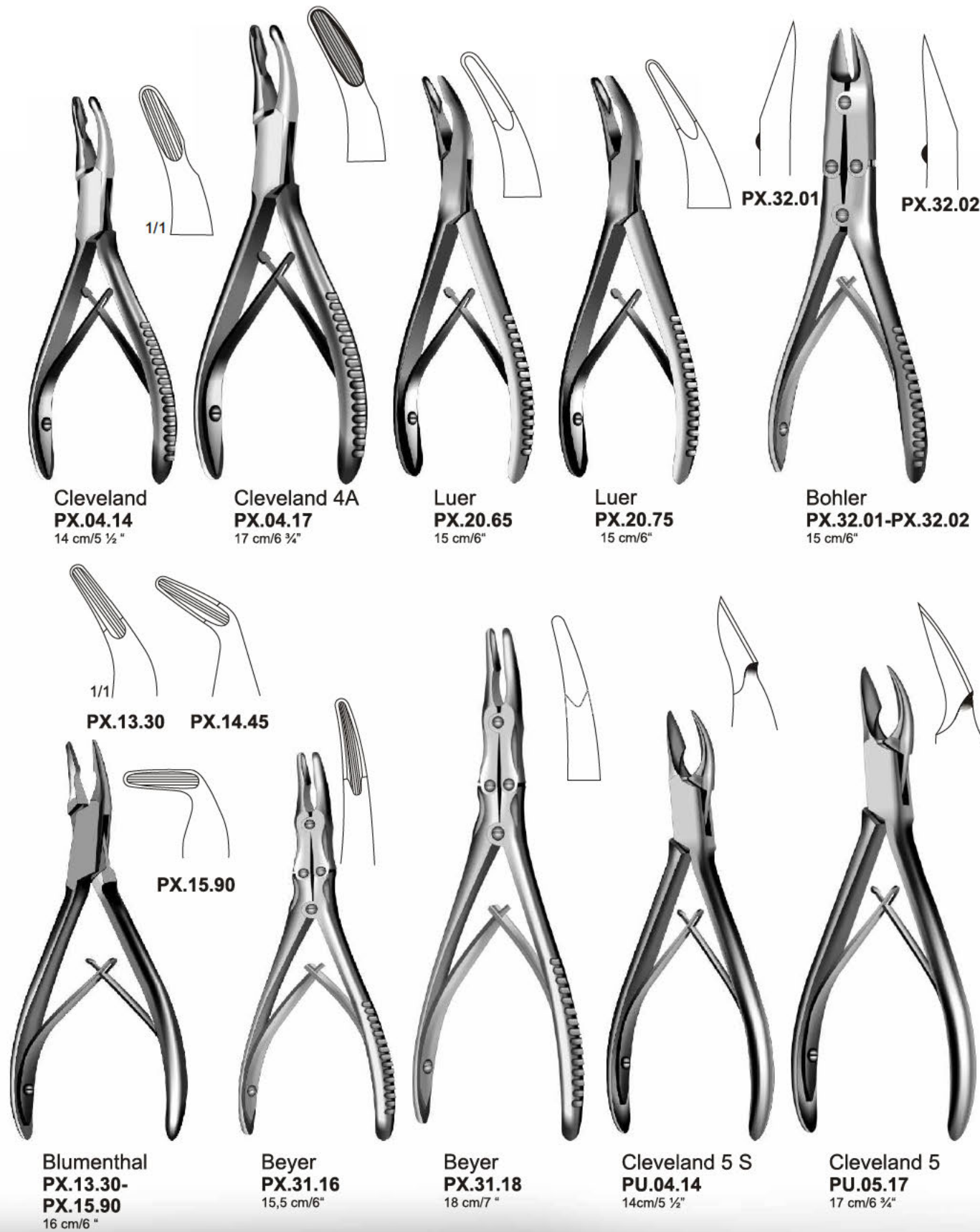

- 2 mm ○ PAE.10.62
- 3 mm ○ PAE.10.63
- 4 mm ○ PAE.10.64
- 5 mm ○ PAE.10.65
- 6 mm ○ PAE.10.66
- 7 mm ○ PAE.10.67
- 8 mm ○ PAE.10.68

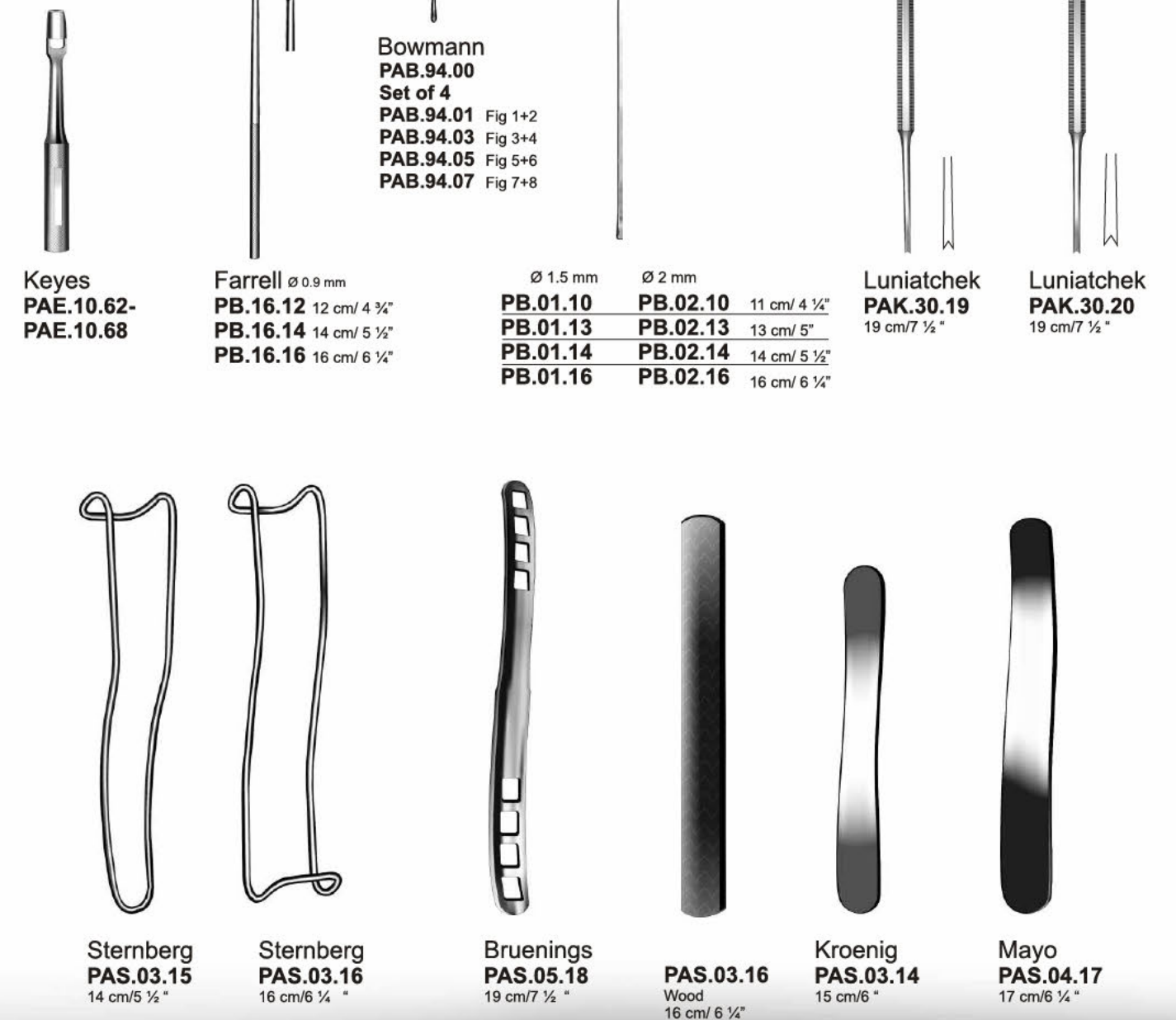



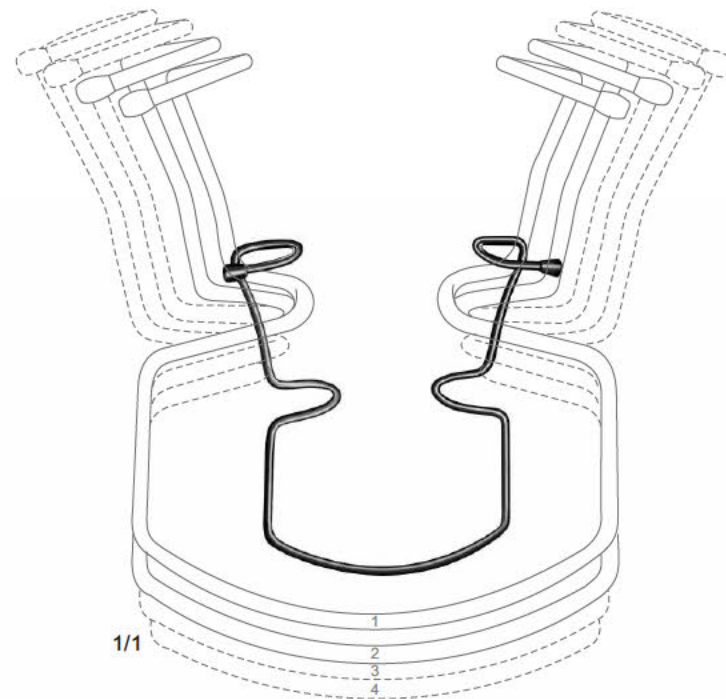

**Oringer**  
**PAQ.01.00** Fig.1  
**PAQ.01.02** Fig.2  
**PAQ.01.03** Fig.3  
**PAQ.01.04** Fig.4  
**PAQ.01.13** Set of 4

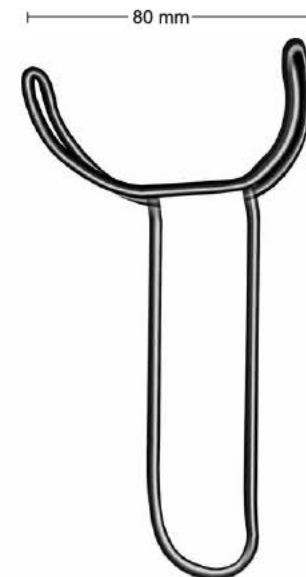

**Vestibulum-Haken**  
**PAQ.01.15**  
 15cm/ 6"



**Heister**  
**PAQ.05.05**  
 13 cm/ 5"

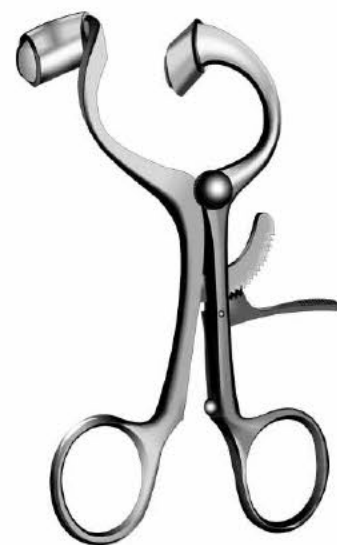

**Molt**  
**PAQ.07.15**  
 15cm/6"



**Jennings**  
**PAQ.09.09** 9 cm/ 3 1/2"  
**PAQ.09.11** 11 cm/ 4 1/4"  
**PAQ.09.13** 13 cm/ 5"  
**PAQ.09.15** 15 cm/ 6"



**Roser-Konig**  
**PAQ.13.45** 16 cm/6 1/4"  
**PAQ.13.50** 20 cm/7 1/2"



**Denhart**  
**PAQ.14.60**  
 13 cm/5"

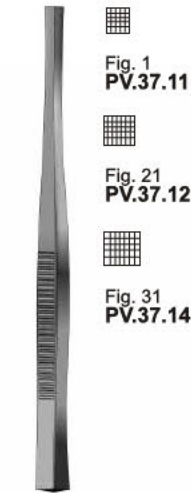

**Passow**  
**PV.37.11-**  
**PV.37.14**  
 12 cm/ 4 3/4"



**Partsch**  
 13,5 cm/5 1/2"    17 cm/6 3/4"  
 3 mm **PV.05.03** **PV.05.53**  
 4 mm **PV.05.04** **PV.05.54**  
 5 mm **PV.05.05** **PV.05.55**  
 6 mm **PV.05.06** **PV.05.56**



**Partsch**  
 13,5 cm/5 1/2"    17 cm/6 3/4"  
**PV.06.03** **PV.06.53**  
**PV.06.04** **PV.06.54**  
**PV.06.05** **PV.06.55**  
**PV.06.06** **PV.06.56**

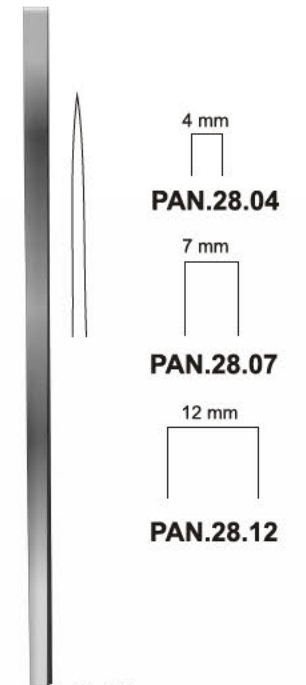

**Cottle**  
**PAN.28.04-**  
**PAN.28.12**

**PW.14.24** Fig.0000  
**PW.14.33** Fig.000  
**PW.14.42** Fig.00  
**PW.14.50** Fig.0  
**PW.14.51** Fig.1  
**PW.14.52** Fig.2  
**PW.14.53** Fig.3  
**PW.14.54** Fig.4  
**PW.14.55** Fig.5  
**PW.14.56** Fig.6



**Volkman**  
**PW.14.22-PW.14.56**  
 17 cm/6 3/4"



**Williger**  
**PW.21.10-**  
**PW.21.12**  
 13,5 cm/5 1/4"

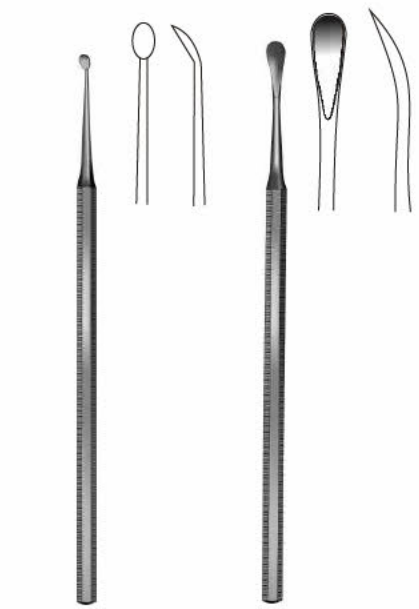

**Partsch**  
**PW.30.15**  
 15 cm/6"  
 Fig.1

**Partsch**  
**PW.31.15**  
 15 cm/6"  
 Fig.2

**Bone Crettes and Mallets**

Scharte Iffel und Hämmer  
 Curetas (Cucharillas) Cortantes y Martillos y Mazos  
 Curettes tranchantes et maillets  
 Cucchiaini per osso e martelli

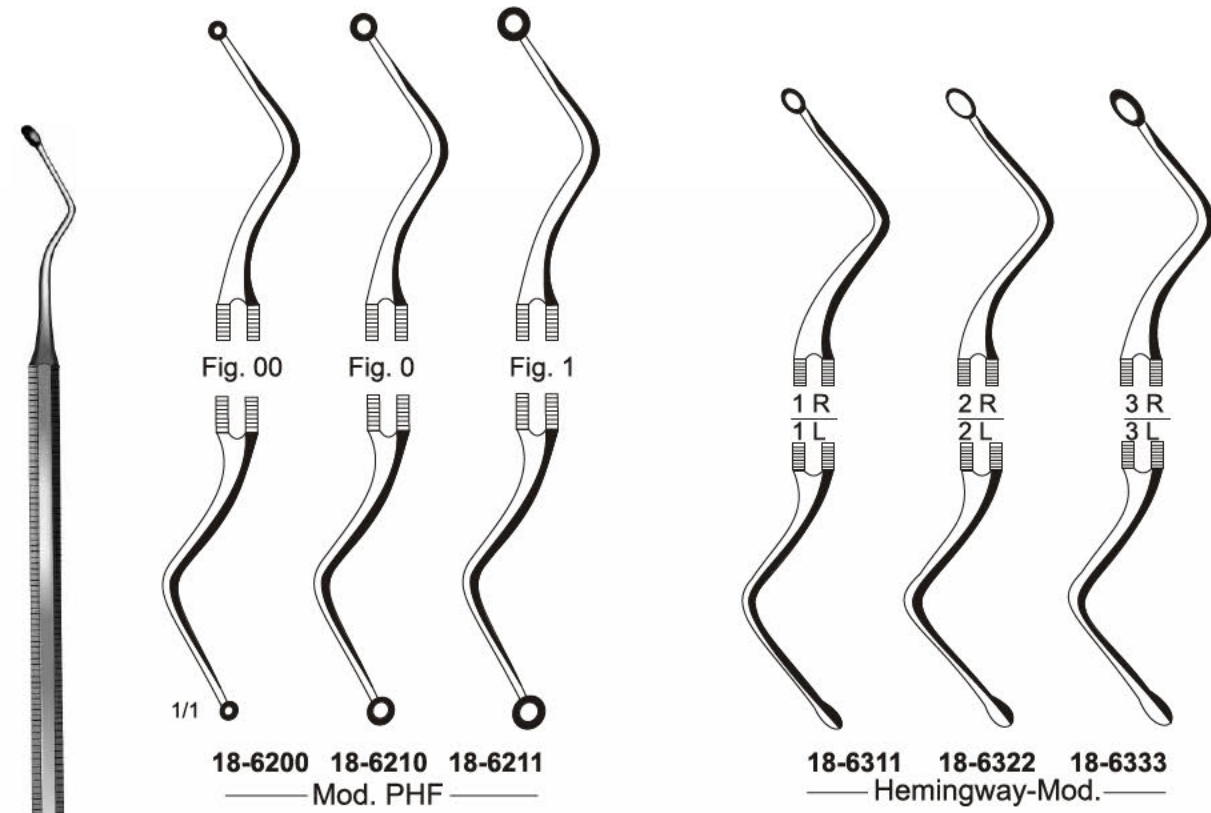

18-6200-18-6211  
 18-6311-18-6333



20 mm Ø  
 150 g (5¼ oz.)  
 Lead filled

**PM.01.16**  
 16,5 cm / 6½"



30 mm Ø  
 220 g (7¾ oz.)

**Collin  
 PM.05.20**  
 20 cm / 8"



26 mm Ø  
 320 g (5¼ oz.)

With interchangeable  
 ferrozell faces  
 fiber  
 18cm

**Mead  
 PM.06.19**  
 Massive - solid  
 17 cm / 6¾"

**Bone Crettes**  
 Scharte Iffel  
 Curetas (Cucharillas) Cortantes  
 Curettes tranchantes  
 Cucchiaini per osso

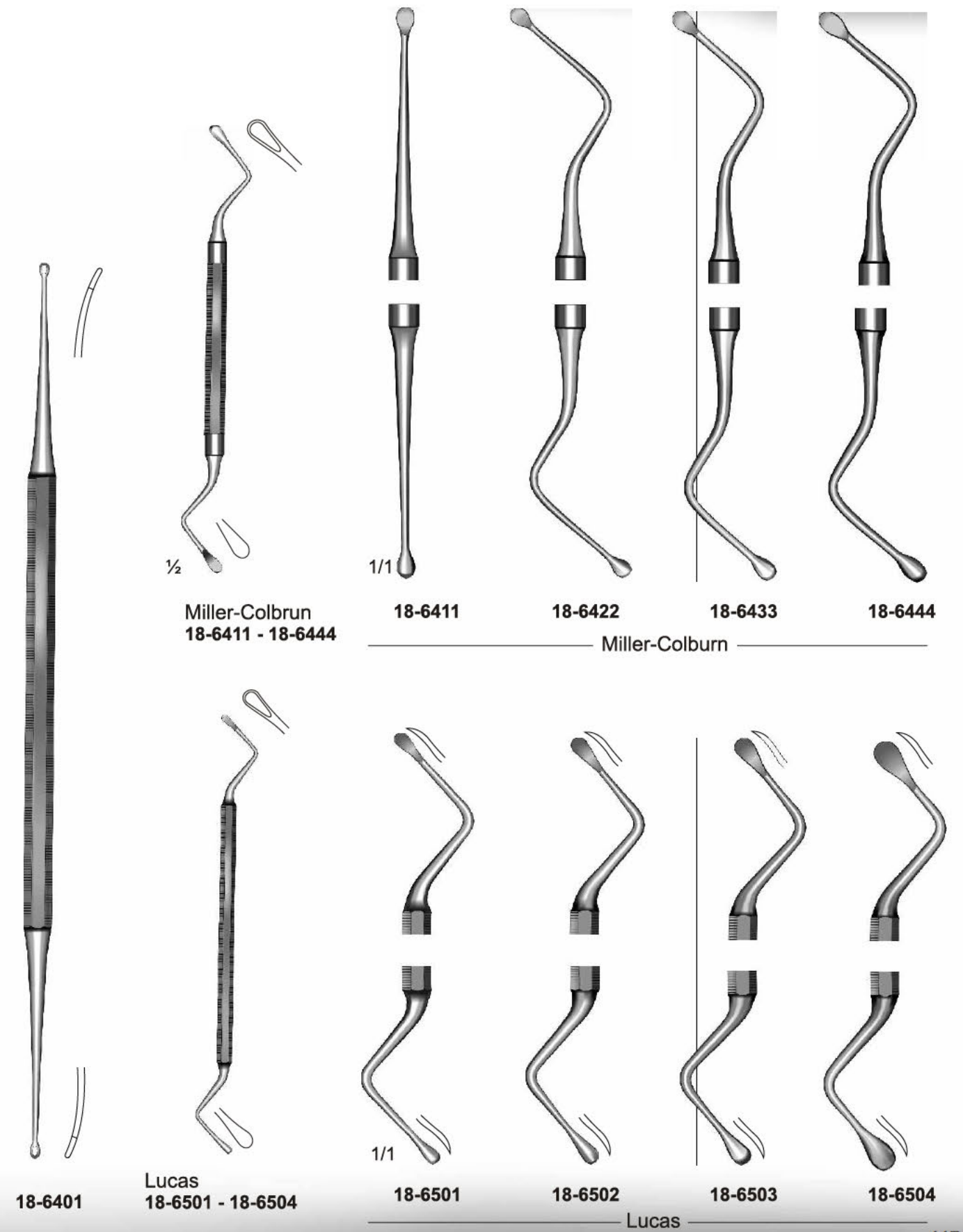

Miller-Colbrun  
 18-6411 - 18-6444

Miller-Colburn

18-6401

Lucas  
 18-6501 - 18-6504

Lucas

**Tongue Depressors / Mouth Gags / Tongue Holding forceps**  
 Zungenspatel / Mundsperrer / Zungenzengen  
 Bajaleguas / Abrebocas / Pinzas ira lengne  
 Ecarteurs des levres / Ouvre-bouches / Pincas tira a  
 Spatola per lingua / Apribocca / Pinza tira lingu

CH 18

www.surgical-i.com



**PAS.02.21**  
14 cm / 5 1/2"

**PAS.02.22**  
15 cm / 6"

**Andrew**  
**PAS.02.11**  
11 cm / 4 1/2"

**Tobold**  
**PAS.01.14**  
14.5 cm / 5 1/2"

**Wieder**  
**PAS.02.21-**  
**PAS.02.22**



**Collin**  
**PAD.14.17**  
17 cm / 6 3/4"

**Guy**  
**PAD.15.36**  
16 cm / 6 1/4"



**PAD.03.03**  
Frame only.

**Davis-Boyle**  
**PAD.02.02**  
Complete  
( 1 Frame + 5 Blades )

**PAD.01.05**  
26 x 110 mm

**PAD.01.04**  
25 x 90 mm

**PAD.01.03**  
24 x 75 mm

**PAD.01.02**  
22 x 65 mm

**PAD.01.01**  
20 x 25 mm

**PAD.06.01**  
(Frame only)

**McIvor**  
**PAD.07.00**  
Complete  
( 1 Frame + 3 Blades )

**PAD.08.03**  
26 x 100 mm

**PAD.08.02**  
25 x 86 mm

**PAD.08.01**  
23 x 70 mm

Needle Cases



**PR.15.05** = 50 x 25 x 4,5 mm  
**PR.15.08** = 65 x 42 x 8 mm  
**PR.15.06** = 75 x 25 x 4,5 mm



**PR.16.05** = 50 x 25 x 4,5 mm  
**PR.16.08** = 65 x 42 x 8 mm  
**PR.16.06** = 75 x 25 x 4,5 mm



complete insert only  
**PR.19.65** **PR.19.70**  
 Ø = 65 mm Ø = 62 mm  
 h = 15 mm h = 13 mm

Trays



**PAF.05.63**  
 235 x 190 x 40 mm

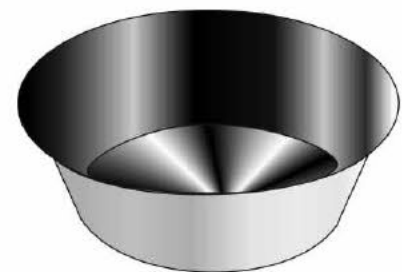
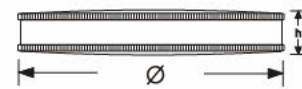

**PAF.05.82**  
 Ø 200 x 70 mm

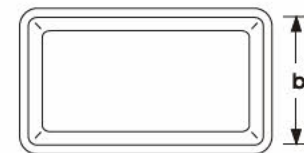

	l	b	h
<b>PAF.04.20</b>	200	150	38
<b>PAF.04.25</b>	250	200	50
<b>PAF.04.30</b>	300	250	50
<b>PAF.04.35</b>	355	305	50
<b>PAF.04.40</b>	405	305	50



**PAF.04.20- PAF.04.40**

Forceps Jars



Size in mm Ø X h	Jar without lid	Jar with lid
30 x 90	<b>PAF.15.30</b>	<b>PAF.15.54</b>
50 x 100	<b>PAF.15.50</b>	<b>PAF.15.55</b>
50 x 130	<b>PAF.15.51</b>	<b>PAF.15.56</b>
50 x 175	<b>PAF.15.52</b>	<b>PAF.15.57</b>
75 x 100	<b>PAF.15.75</b>	<b>PAF.15.80</b>
75 x 130	<b>PAF.15.76</b>	<b>PAF.15.81</b>
75 x 175	<b>PAF.15.77</b>	<b>PAF.15.82</b>
100 x 175	<b>PAF.15.98</b>	<b>PAF.15.88</b>
100 x 200	<b>PAF.15.99</b>	<b>PAF.15.89</b>

Instrument Box



**PAF.20.20**  
 205 x 105 x 40 mm

Kidney Trays



Size in mm l x b x h		
170 x 100 x 35	<b>PAF.10.17</b>	17 cm/ 6 3/4"
250 x 140 x 40	<b>PAF.10.25</b>	25 cm/ 10"
275 x 150 x 45	<b>PAF.10.27</b>	27 cm/ 10 3/4"

Instrument Boxes

Size in mm			
L	w	x h	
165	85	35	<b>PAF.21.46</b>
200	100	35	<b>PAF.21.50</b>
200	100	50	<b>PAF.21.51</b>
230	130	50	<b>PAF.21.53</b>
260	150	50	<b>PAF.21.56</b>
270	235	50	<b>PAF.21.57</b>
300	200	50	<b>PAF.21.60</b>
325	275	30	<b>PAF.21.62</b>
325	275	50	<b>PAF.21.63</b>
420	80	40	<b>PAF.21.72</b>
420	175	50	<b>PAF.21.75</b>



Cotton Dispensers



**Methot**  
**PAF.35.01** **PAF.35.02**  
 ø50 x 75 mm  
 With lid Without lid



**Spirit Lamp**  
**19-1505**  
 120 cc

Cotton wool containers



Size in mm	Lid with knob	
ø X h		
75 x 60		<b>PAF.08.07</b>
75 x 75		<b>PAF.08.08</b>
100 x 60		<b>PAF.08.10</b>
100 x 100		<b>PAF.08.11</b>
125 x 80		<b>PAF.08.12</b>
125 x 125		<b>PAF.08.13</b>
150 x 100		<b>PAF.08.14</b>
150 x 150		<b>PAF.08.15</b>
200 x 100		<b>PAF.08.20</b>
200 x 150		<b>PAF.08.21</b>
200 x 200		<b>PAF.08.22</b>
240 x 160		<b>PAF.08.24</b>
240 x 230		<b>PAF.08.25</b>
290 x 160		<b>PAF.08.29</b>
290 x 240		<b>PAF.08.30</b>

Sterilization Drums



**Schimmelbusch**  
 (Horizontal Ventilation)

Ø	h	
140	140	<b>PR.25.14</b>
160	150	<b>PR.25.16</b>
190	160	<b>PR.25.19</b>
190	190	<b>PR.25.20</b>
240	120	<b>PR.25.24</b>
240	160	<b>PR.25.25</b>
240	240	<b>PR.25.27</b>
290	160	<b>PR.25.29</b>
290	240	<b>PR.25.30</b>
340	160	<b>PR.25.34</b>
340	240	<b>PR.25.35</b>
390	140	<b>PR.25.39</b>
390	190	<b>PR.25.40</b>
390	290	<b>PR.25.41</b>



**Konrich**  
 (Vertical Ventilation)

Ø	h	
140	140	<b>PR.26.14</b>
160	150	<b>PR.26.16</b>
190	160	<b>PR.26.19</b>
190	190	<b>PR.26.20</b>
240	120	<b>PR.26.24</b>
240	160	<b>PR.26.25</b>
240	240	<b>PR.26.27</b>
290	160	<b>PR.26.29</b>
290	240	<b>PR.26.30</b>
340	160	<b>PR.26.34</b>
340	240	<b>PR.26.35</b>
390	140	<b>PR.26.39</b>
390	190	<b>PR.26.40</b>
390	290	<b>PR.26.41</b>

Sterilization, Asepsis  
 Sterilisation, Asepsis  
 Esterilización, Asepsia  
 Stérilisation, Asepsis  
 Sterilizzazione, Asepsi

CH 19

www.surgical-i.com

# CH 20

Surgery  
 Chirurgie  
 Chirguia  
 Chirurgie  
 Chirurgia

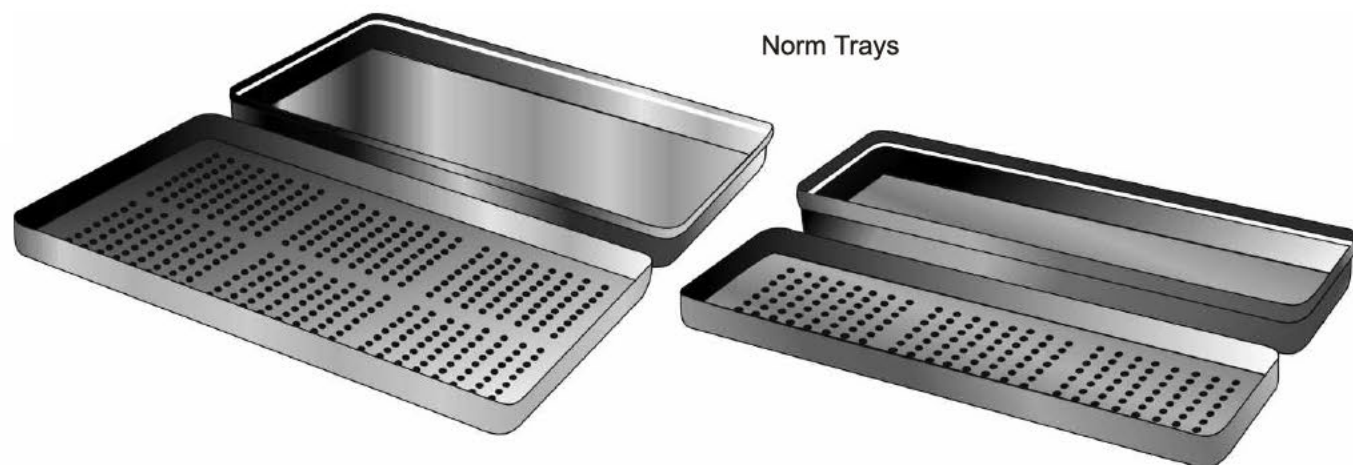

Norm Trays

**19-2101 - 19-2104**  
 288 x 187 x 40 mm

**19-2201 - 19-2204**  
 288 x 93 x 40 mm

	Tablet	Lid	
19-2101	Perforated	Unperforated	19-2201
19-2102	Unperforated	Unperforated	19-2202
19-2103	Perforated	Perforated	19-2203
19-2104	Unperforated	Perforated	19-2204

Inserts for Trays

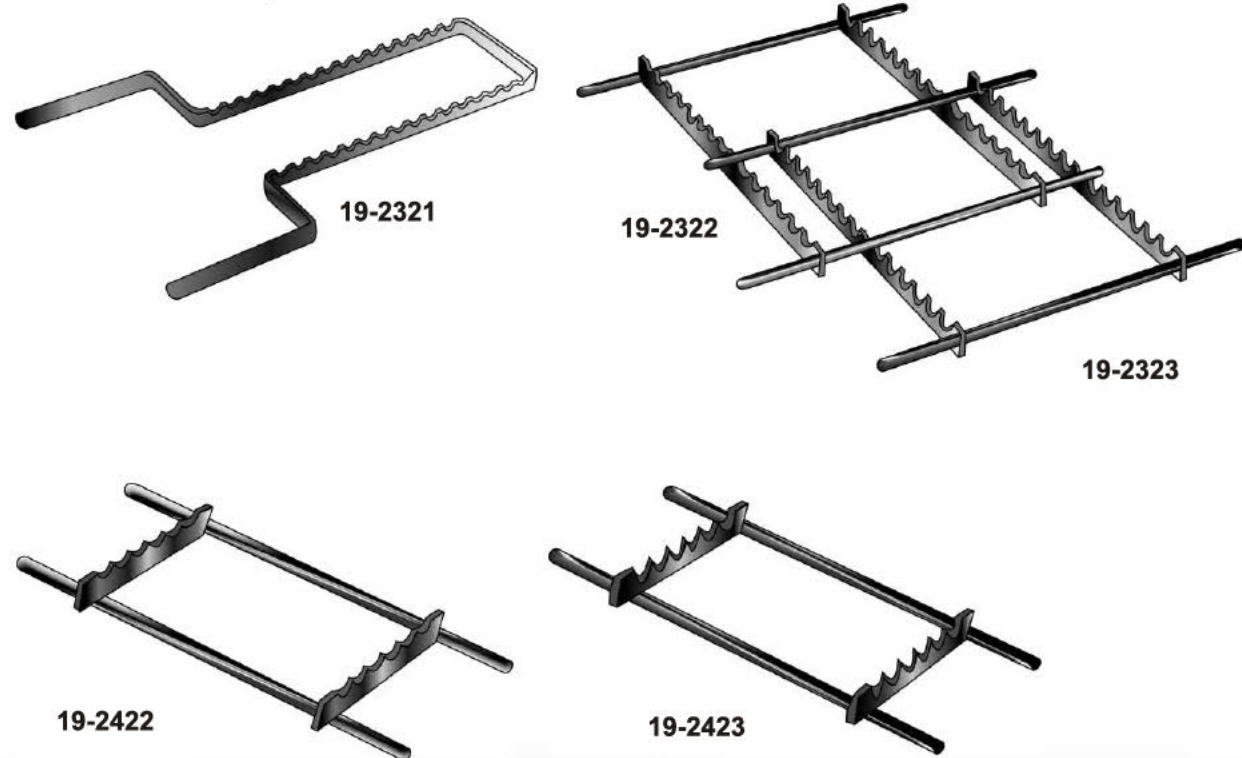

19-2321

19-2322

19-2323

19-2422

19-2423



Suction Tubes

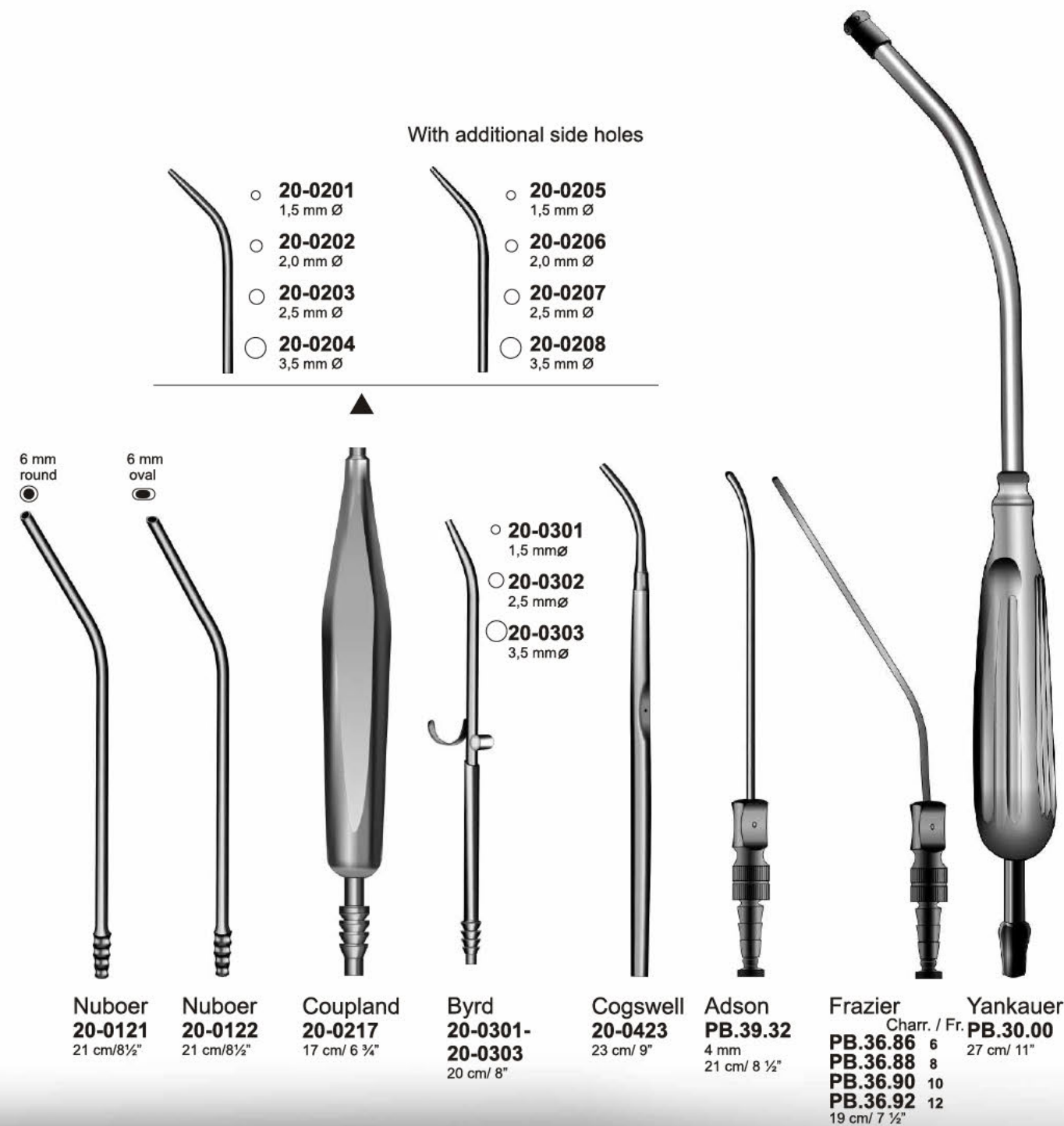

Cartridge / Water Syringes

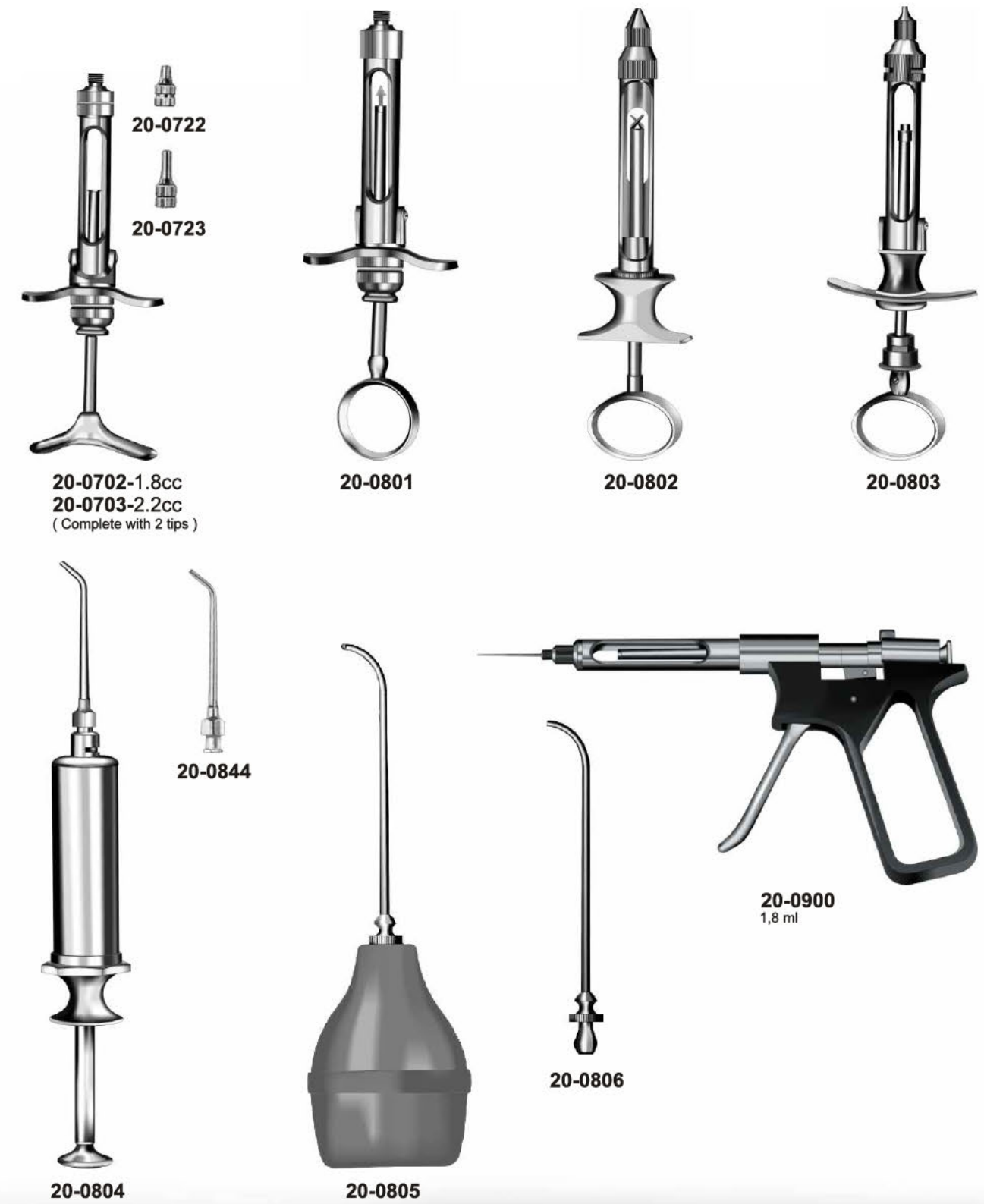

Chiropody Instruments

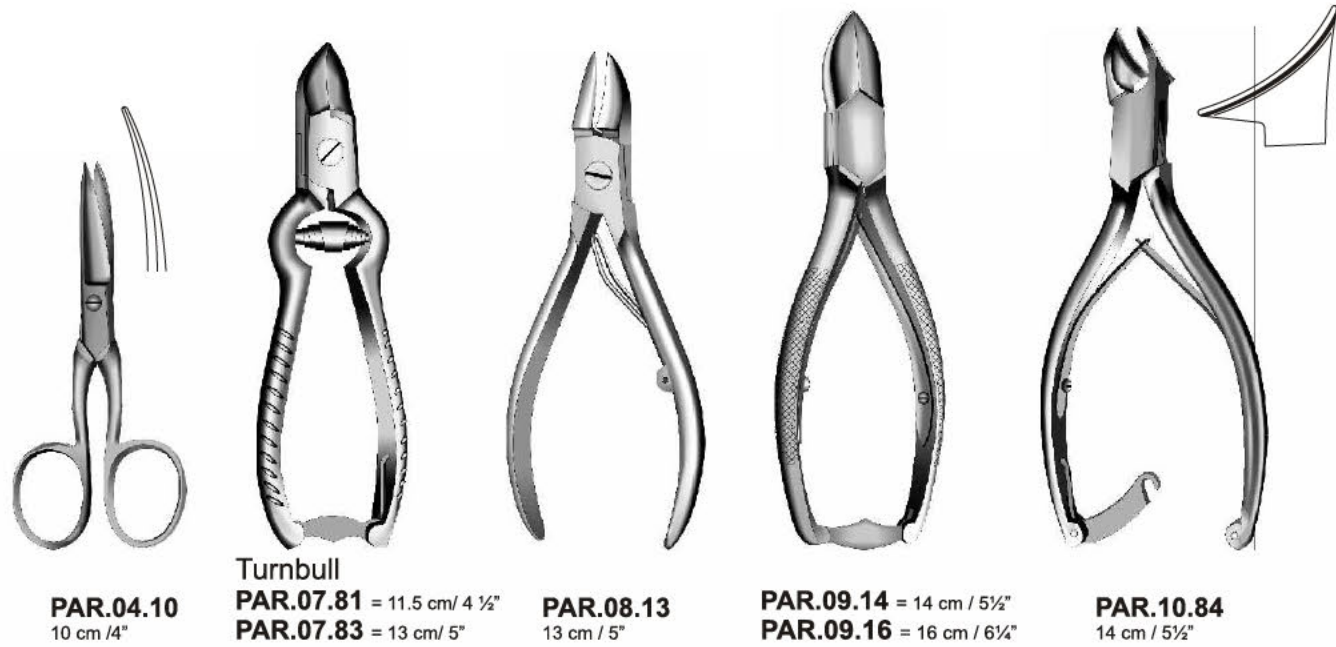

PAR.04.10  
10 cm / 4"

Turnbull  
PAR.07.81 = 11.5 cm / 4 1/2"  
PAR.07.83 = 13 cm / 5"

PAR.08.13  
13 cm / 5"

PAR.09.14 = 14 cm / 5 1/2"  
PAR.09.16 = 16 cm / 6 1/4"

PAR.10.84  
14 cm / 5 1/2"

Sterilization Forceps



Cheatle  
PR.03.27  
27 cm / 10 1/2"

PAD.19.30  
30 cm / 12"



Spatulas

20-1919 = 19 cm / 7 1/2"  
20-1922 = 22 cm / 8 1/2"  
20-1925 = 25 cm / 10"

20-2021  
21 cm / 8 1/4"  
105 x 30 mm  
elastic

20-2120  
20 cm / 8"  
100 x 23 mm  
rigid

20-2219  
19 cm / 7 1/2"  
100 x 17 mm  
elastic



Napkin Holders

Professional  
20-2301  
length adjustable

Adams  
20-2302

Finger Guards

20-2401

20-2402

20-2403

Langenbeck  
20-2401 - 20-2403

Sand glass



20-2500

Spring Caliper



20-2601



20-2602



Iwanson  
20-2603



Iwanson  
20-2604

Micro meters



Boley  
20-2710



Oral wedge

Maunder  
PAQ.64.10



Mouth mirrors and handles for mouth mirrors  
 Mundspiegel und Mundspiegelgriffe  
 Espejos de boca y mango para espejos de boca  
 Miroirs à bouche Manche pour miroirs  
 Specchietti e manici per specchietti

CH 20

www.surgical-i.com



Ø mm	Sizes	Plane, Cone-Socket	Magnifying, Cone Socket	Ø mm	Sizes	Plane, simple thread	Magnifying, simple thread
22	4	<b>20-2922</b>	<b>20-3022</b>	22	4	<b>20-3122</b>	<b>20-3222</b>
24	5	<b>20-2924</b>	<b>20-3024</b>	24	5	<b>20-3124</b>	<b>20-3224</b>

Handles for mirrors

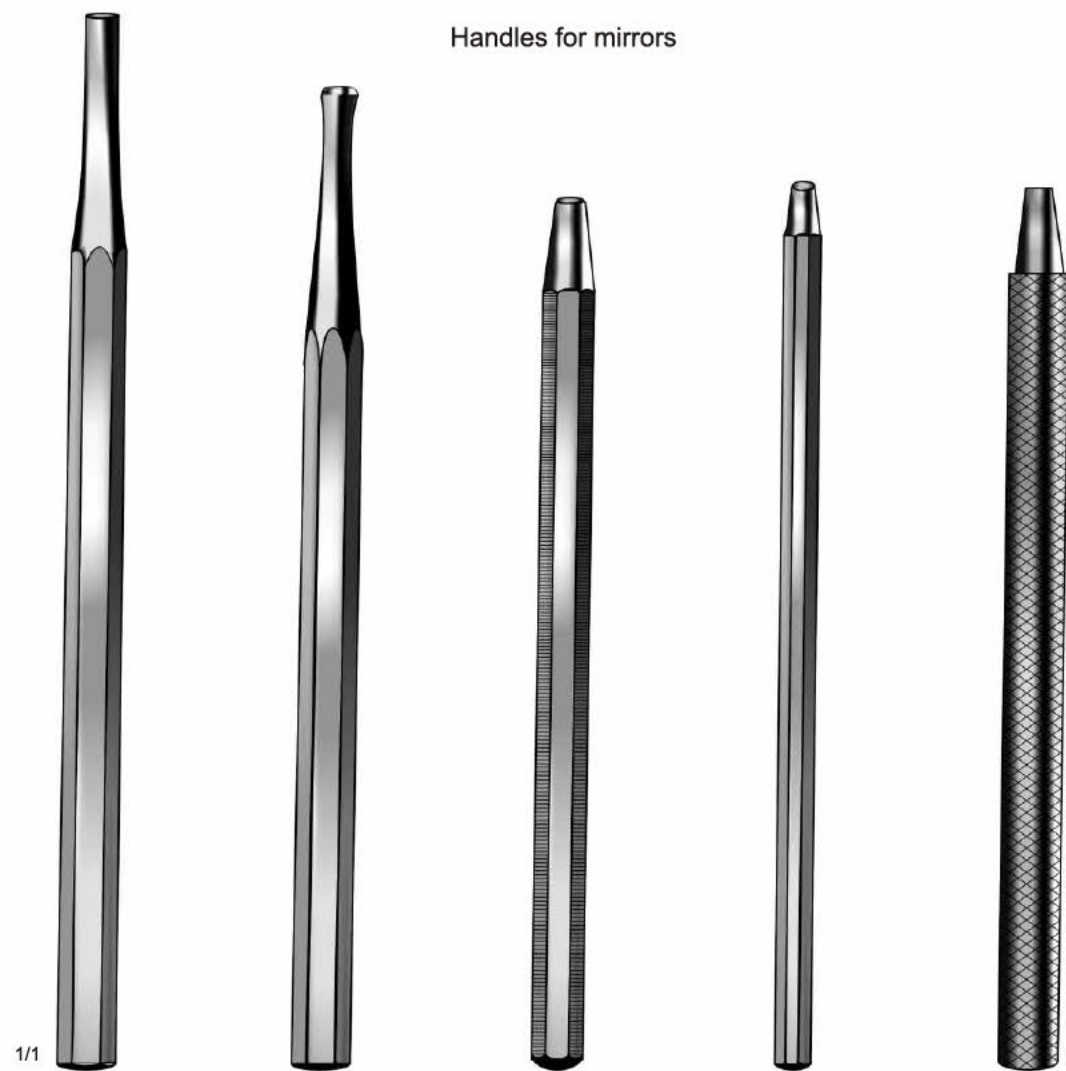

1/1  
 With simple thread **20-3301**  
 With Cone-Socket **20-3302**  
**Secco 20-3401**  
**20-3501**  
**20-3601**  
**20-3701**

# CH 21

Dental instruments sets  
 Satz Instrumente  
 Sistema de instrumentos  
 Ensemble d' instruments  
 Insieme degli strumenti



Supplied in Leather wallets



**21-0108**, Set of 8., Containing

- 01-0101 Dental Extracting Forceps, No.1
- 01-0113 Dental Extracting Forceps, No.13
- 01-0117 Dental Extracting Forceps, No.17
- 01-0118 Dental Extracting Forceps, No.18
- 01-0751 Dental Extracting Forceps, No.51A
- 01-1067 Dental Extracting Forceps, No.67
- 01-1379 Dental Extracting Forceps, No.39

**21-0209** Set of 9, Containing

- 01-0333 Dental Extracting Forceps, No.33
- 01-0751 Dental Extracting Forceps, No.51A
- 01-1067 Dental Extracting Forceps, No.67
- 01-1379 Dental Extracting Forceps, No.79
- 05-0203 Root Elevators, 3mm, 13.5 cm/ 5 1/4"
- 05-2302 Root Elevators, No. 302
- 05-2303 Root Elevators, No. 303
- PJ.69.14 Mayo Hegar Needle Holder, 16 cm, T/C
- PJ.23.56 Mathieu Needle Holder, 14cm, T/C



**21-0309** Set of 9 , Containing

- 01-0333 Dental Extracting Forceps, No.33
- 01-0751 Dental Extracting Forceps, No.51
- 01-1067 Dental Extracting Forceps, No.67
- 01-1379 Dental Extracting Forceps, No.79
- 05-0203 Root Elevators, 3mm, 13.5 cm/ 5 1/4"
- 05-2302 Root Elevators, No. 302
- 05-2303 Root Elevators, No. 303
- 05-4320 Dental Extracting Forceps, No.320
- 05-4321 Dental Extracting Forceps, No.321



**21-0408** Set of 8, Containing

- 01-0101 Dental Extracting Forceps, No.1
- 01-0104 Dental Extracting Forceps, No.4
- 01-0107 Dental Extracting Forceps, No.7
- 01-0113 Dental Extracting Forceps, No.13
- 01-0117 Dental Extracting Forceps, No.17
- 01-0118 Dental Extracting Forceps, No.18
- 01-0220 Dental Extracting Forceps, No.20
- 01-1686 Dental Extracting Forceps, No.6C



Periodontal Instruments Set

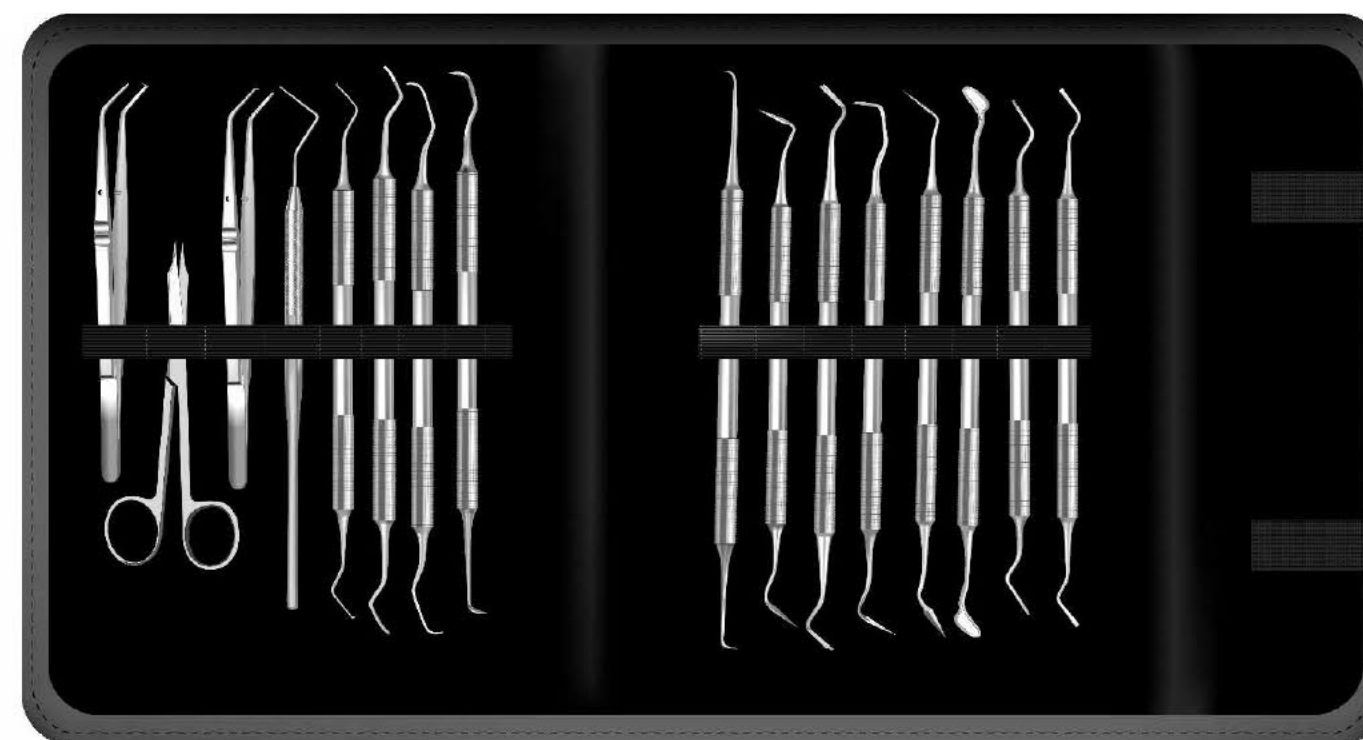

**21-0508** Set of 16 Periodontia Instruments, Containing in artificial Leather case :

- 08-2101 Goldman-Fox Curettes 16cm/ 6 1/4"
- 08-2102 Goldman-Fox Curettes 16cm/ 6 1/4"
- 08-2103 Goldman-Fox Curettes 16cm/ 6 1/4"
- 08-2104 Goldman-Fox Curettes 16cm/ 6 1/4"
- 08-2105 Goldman-Fox Curettes 16cm/ 6 1/4"
- 08-2106 Goldman-Fox Curettes 16cm/ 6 1/4"
- 08-1507 Goldman-Fox Knives
- 08-1508 Goldman-Fox Knives
- 08-1509 Goldman-Fox Knives
- 08-1510 Goldman-Fox Knives
- 08-1511 Goldman-Fox Knives
- 08-1521 Goldman-Fox Knives
- PC.90.13 Goldman Fox, Gum Scissors 13 cm/ 5 1/8"
- 15-3301 Crane-Keplan Dental Tweezers 14 cm/ 5 1/2"
- 15-3302 Crane-Keplan Dental Tweezers 14 cm/ 5 1/2"



	<i>Page</i>		<i>Page</i>
Plastic Filling Instruments	38,41	Suction Tubes	126
Pliers, Bond Bracket	91,92	Surgery Instruments	125,130
Pliers, Contouring	89	Syringes Cartridges	127
Pliers, Copper Ring and Bridge Removing	90	Syringes, Water	127
Pliers, Crown	89		
Pliers, Flat Nose	88	<b>T</b>	
Pliers, Loop Forming & Bending	94,95	Thomas Modelling Carvers	69
Pliers, Orthodontic	88,96	Tobold Tongue Depressors	118
Pliers, Bar Bending	88	Tofflemire Matrix Bands	73
Pliers, Band Seating	91	Tofflemire Universal Matrix Retainers	73
Pliers, Universal	90	Tomes Extracting Forceps	20
Pliers, Wire Arch and Clasp Bending	89,91,93	Tongue Depressors	113,118
Pliers, Wire Cutting Pliers	96	Towner Jaquette Periodontia Instruments	52
Pott Root Elevators	31	Trays, Half	124
Prichard Periodontia Instruments	53	Trays, Instruments Storing	120
Probes (Explorers)	62,63	Trays, Norm	124
Probes Periodontia	50	Trays, Universal	100
Professional Napkin Holders	129	Treyemann Instruments for Crown Work	71
		Tuft Wax, Porcelain and Modelling Carvers	68
<b>Q</b>		Turnbull Nipper, Nail	128
Quinby Gum Scissors	100	Tweed Bending & Forming Pliers	93,95
		Tweezers, Cotton & Dressing	103,104
<b>R</b>		<b>U</b>	
Ragnell (Kilner) Gum Scissors, TC	101	Universal Curettes	47,48
Ralk Forceps, Splinter	106	Universal Pliers	90
Raspatories, Periosteal	111	Universal Wire and Crown Scissors	100,101
Retractors	109,110	USA Mod Dental Tweezers	104
Retractors, Cheek and Lip	113		
Retractors, Soft Tissue	110	<b>V</b>	
Reynolds Pliers	89,93	Vestibulum Haken	114
Rochester Pean Hemostatic Forceps	106	Volkman Bone Curettes	115
Root Elevators	26,32	Volkman Retractors	110
Roser Konig Mouth Gag	114		
Roux Retractors	109	<b>W</b>	
Rubber Dam Instruments	74	Wagner Gum Scissors	100
Rule Universal Curettes	48	Waldsachs Universal Pliers	90
		Walter F. Barry Root Elevators	28,30,32
<b>S</b>		Ward Wax, Porcelain and Modelling Carver	68
Sachs Instruments for Crown Work	71	Ward Kirkland Periodontia Instruments	51
Sand Glass	129	Warwick James Root Elevators	32
Scalers	46,48	Wax, Porcelain and Modelling Carvers	68,70
Scalpel Handles	98	Wedges, Oral	129
Scalpel Blades	98	Weingart Pliers	94
Schimmelbusch Sterilizing Drums	123	West Root Elevators	32
Schroeder Instruments for Crown Work	71	White Burnishers	42
Schwarz Pliers, Bar Bending	88	White Excavators	59
Scissors	99,101	White Plastic Filling Instruments	39
Scissors, Cuticle	128	Wieder Tongue Depressors	118
Scissors, Dissecting	99,101	Wiland Wax, Porcelain and Modelling Carvers	68
Scissors, Gum	99,100	Williams Plastic Filling Instruments	38
Scissors, Gum, TC	101	Williger Bone Curettes	115
Scissors, Nail	128	Williger Elevators	111
Scissors, Operating Fine	99	Winter Root Elevators	30
Scissors, Operating	99	Woodson Plastic Filling Instruments	39
Scissors, TC	99,101	Woodward Extracting Forceps	17
Scissors, Wire and Crown	100,101		
Seldin Root Elevators	28	<b>Y</b>	
Semken Tissue Forceps	102	Yankauer Suction Tubes	126
Senn Miller Retractors	109	Yonger Good Universal Curettes	48
Sets, Dental Instruments	132,133	Young Pliers, Wire, Arch and Clasp Bending	89
Sliding Caliper	129		
Spatulas	128	<b>Z</b>	
Spatulas, Cement	43,44,128	Zahle Wax Knife	69
Spirit Lamp	122		
Spring Calipers	129		
Stadler Pliers	89		
Standard Extracting Forceps, American Pattern	16,24		
Standard Forceps, Dressing	102		
Standard Scalpel Handles	98		
Standard Scissors, Operating	99		
Sterilization	119,124		
Sterilizing Drums	123		
Stenberg Retractors, Cheek and Lip	113		
Stieglitz Splinter Forceps	106		
Stockes Rubber Dam Instruments	74		